

# Perspectives of Nuclear Physics in Europe

NuPECC Long Range Plan 2010

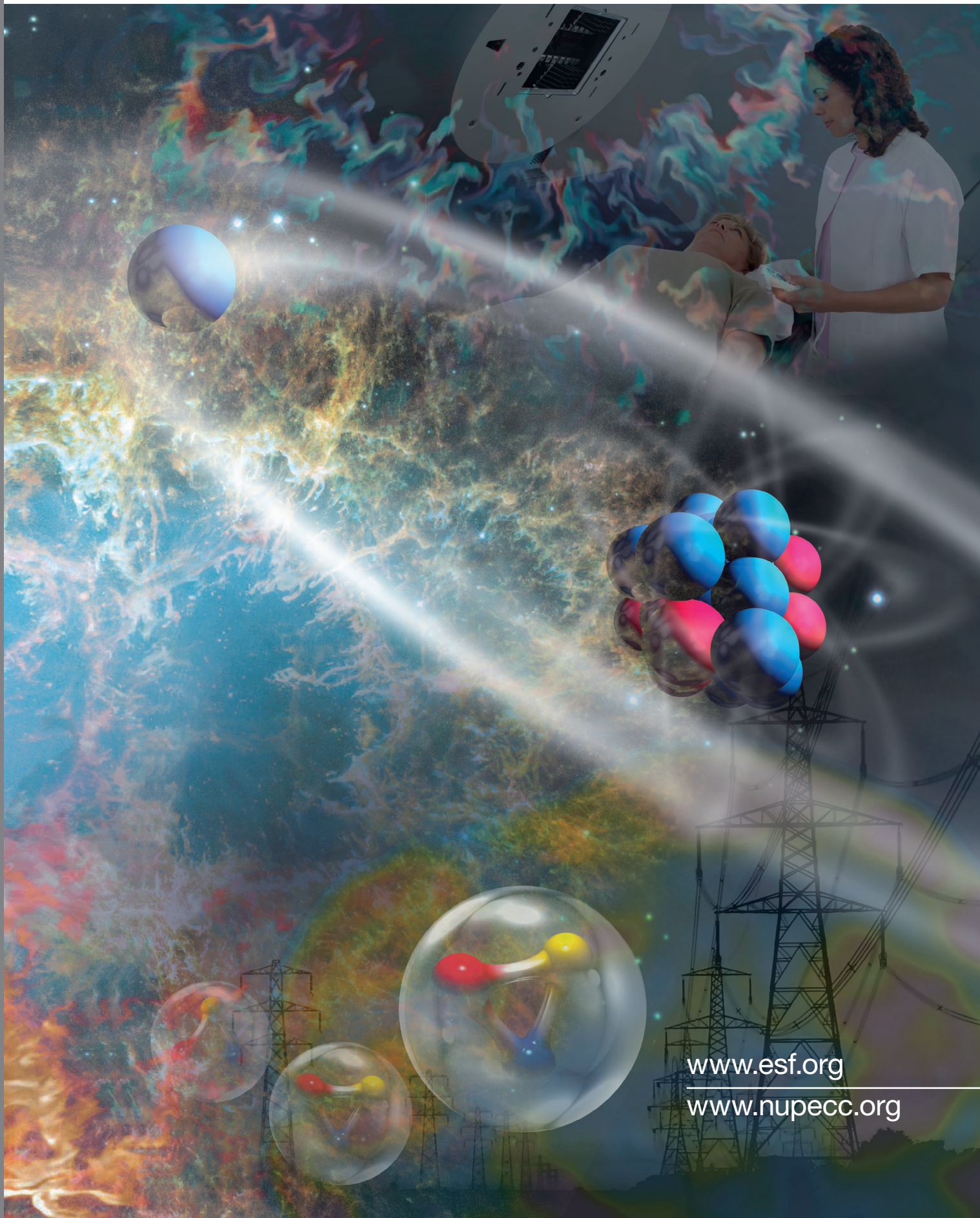

---

### **European Science Foundation**

The European Science Foundation (ESF) is an independent, non-governmental organisation, the members of which are 79 national funding agencies, research performing agencies, academies and learned societies from 30 countries.

The strength of ESF lies in the influential membership and in its ability to bring together the different domains of European science in order to meet the challenges of the future.

Since its establishment in 1974, ESF, which has its headquarters in Strasbourg with offices in Brussels and Ostend, has assembled a host of organisations that span all disciplines of science, to create a common platform for cross-border cooperation in Europe.

ESF is dedicated to promoting collaboration in scientific research, funding of research and science policy across Europe. Through its activities and instruments ESF has made major contributions to science in a global context. The ESF covers the following scientific domains:

- Humanities
- Life, Earth and Environmental Sciences
- Medical Sciences
- Physical and Engineering Sciences
- Social Sciences
- Marine Sciences
- Materials Science and Engineering
- Nuclear Physics
- Polar Sciences
- Radio Astronomy
- Space Sciences

[www.esf.org](http://www.esf.org)

---

### **Forward Looks**

The Forward Looks are the flagship activity of ESF's strategic arm. Forward Looks enable Europe's scientific community, in interaction with policy makers, to develop medium to long-term views and analyses of future research developments with the aim of defining research agendas at national and European level. Forward Looks are driven by ESF's Member Organisations and, by extension, the European research community.

[www.esf.org/flooks](http://www.esf.org/flooks)

### **Nuclear Physics European Collaboration Committee (NuPECC)**

The Nuclear Physics European Collaboration Committee (NuPECC) is an Expert Committee of the European Science Foundation. The aim of NuPECC is to strengthen collaboration in nuclear science by promoting nuclear physics, and its trans-disciplinary use and application, in collaborative ventures between European research groups, and particularly those from countries linked to the European Science Foundation (ESF). NuPECC encourages the optimal use of a network of complementary facilities across Europe, provides a forum for discussing the provision of future facilities and instrumentation, and advises and makes recommendations to the ESF and other bodies on the development, organisation, and support of European nuclear research, particularly on new projects. The Committee is supported by its subscribing institutions which are, in general, member organisations of the ESF involved in nuclear science and research or research facilities.

[www.nupecc.org](http://www.nupecc.org)

---

### **NuPECC Long Range Plan 2010**

Nuclear Physics: Science and Applications  
Perspectives of Research in Europe

#### **Edited by**

Angela Bracco, Philippe Chomaz,  
Jens Jørgen Gaardhøje, Paul-Henri Heenen,  
Günther Rosner (Chair), Eberhard Widmann,  
and Gabriele-Elisabeth Körner



# Contents

---

|  |           |
|--|-----------|
| <b>Foreword</b>  | <b>3</b>  |
| <hr/>  |           |
| <b>1. Executive Summary</b>                                | <b>5</b>  |
| <b>1.1. Outline</b>  | <b>5</b>  |
| 1.1.1 Scientific Scope                                     | 5         |
| 1.1.2 Societal Scope                                       | 5         |
| 1.1.3 Objectives   | 6         |
| 1.1.4 Forward Look   | 6         |
| <b>1.2. The Big Picture</b>                                | <b>6</b>  |
| <b>1.3. Research Infrastructures and Networking</b>        | <b>7</b>  |
| 1.3.1 Current Research Infrastructures and Upgrades        | 7         |
| 1.3.2 Future Research Infrastructures                      | 8         |
| 1.3.3 Collaboration at European and Global Level           | 10        |
| <b>1.4. Scientific Themes</b>                              | <b>11</b> |
| 1.4.1 Hadron Physics                                       | 11        |
| 1.4.2 Phases of Strongly Interacting Matter                | 12        |
| 1.4.3 Nuclear Structure and Dynamics                       | 13        |
| 1.4.4 Nuclear Astrophysics                                 | 15        |
| 1.4.5 Fundamental Interactions                             | 16        |
| 1.4.6 Nuclear Physics Tools and Applications               | 17        |
| <hr/>  |           |
| <b>2. Recommendations and Roadmap</b>                      | <b>19</b> |
| <b>2.1. Recommendations</b>                                | <b>19</b> |
| <b>2.2. Facilities Roadmap</b>                             | <b>20</b> |
| <hr/>  |           |
| <b>3. Research Infrastructures and Networking</b>          | <b>21</b> |
| <b>3.1. Existing Research Infrastructures and Upgrades</b> | <b>21</b> |
| 3.1.1 Theory and Computing                                 | 21        |
| 3.1.2 Lepton Beam Facilities                               | 22        |
| 3.1.3 Hadron Beam Facilities                               | 27        |
| 3.1.4 Smaller-Scale Facilities                             | 38        |
| <b>3.2. Future Research Infrastructures</b>                | <b>40</b> |
| 3.2.1 ESFRI Roadmap Facilities                             | 40        |
| 3.2.2 Planned ESFRI Facilities                             | 44        |
| 3.2.3 Major Upgrades of Existing Facilities                | 45        |
| 3.2.4 Travelling Detectors                                 | 48        |
| 3.2.5 Projects and Design Studies                          | 49        |
| <b>3.3. Collaboration at European and Global Level</b>     | <b>54</b> |
| 3.3.1 Collaboration in Europe                              | 54        |
| 3.3.2 Global Collaboration                                 | 57        |
| <hr/>  |           |
| <b>4. Scientific Themes</b>                                | <b>59</b> |
| <b>4.1. Hadron Physics</b>                                 | <b>59</b> |
| 4.1.1 Introduction   | 60        |
| 4.1.2 Basic Properties of Quantum Chromodynamics           | 61        |
| 4.1.3 Hadron Structure                                     | 63        |
| 4.1.4 Hadron Spectroscopy                                  | 69        |
| 4.1.5 Hadronic Interactions                                | 73        |
| 4.1.6 Recommendations                                      | 77        |

# Contents

---

|   |            |
|---|------------|
| <b>4.2 Phases of Strongly Interacting Matter</b>                          | <b>79</b>  |
| 4.2.1 Introduction  | 80         |
| 4.2.2 The QCD Phase Diagram   | 82         |
| 4.2.3 Strongly Interacting Matter in the Nucleonic Regime                 | 86         |
| 4.2.4 Exploring the QCD Phase Diagram at Large Baryon-Chemical Potentials | 89         |
| 4.2.5 The High-Energy Frontier  | 93         |
| 4.2.6 R&D, Computing, Networking  | 100        |
| 4.2.7 Recommendations   | 101        |
| <b>4.3 Nuclear Structure and Dynamics</b>                                 | <b>103</b> |
| 4.3.1 Introduction  | 104        |
| 4.3.2 Theoretical Aspects   | 105        |
| 4.3.3 Onset of Complexity   | 110        |
| 4.3.4 Shell Structure and the Isospin Degree of Freedom                   | 111        |
| 4.3.5 Collective Properties   | 116        |
| 4.3.6 Reaction Dynamics   | 119        |
| 4.3.7 Ground-State Properties   | 121        |
| 4.3.8 Facilities and Instrumentation                                      | 123        |
| 4.3.9 Recommendations   | 127        |
| <b>4.4 Nuclear Astrophysics</b>   | <b>129</b> |
| 4.4.1 Introduction  | 130        |
| 4.4.2 State of the Art and Future Directions                              | 132        |
| 4.4.3 Future Requirements for Experiment and Theory                       | 140        |
| 4.4.4 Conclusions   | 147        |
| <b>4.5 Fundamental Interactions</b>                                       | <b>151</b> |
| 4.5.1 Introduction  | 152        |
| 4.5.2 Fundamental Fermions  | 153        |
| 4.5.3 Discrete Symmetries   | 161        |
| 4.5.4 Properties of Known Basic Interactions                              | 167        |
| 4.5.5 Future Directions   | 171        |
| 4.5.6 Recommendations   | 172        |
| <b>4.6 Nuclear Physics Tools and Applications</b>                         | <b>175</b> |
| 4.6.1 Introduction  | 176        |
| 4.6.2 Nuclear Energy  | 176        |
| 4.6.3 Life Sciences   | 179        |
| 4.6.4 Environmental and Space Applications                                | 183        |
| 4.6.5 Security  | 186        |
| 4.6.6 Applications in Materials Science and Other Fundamental Domains     | 188        |
| 4.6.7 Cultural Heritage, Arts and Archaeology                             | 191        |
| 4.6.8 New Frontiers in Nuclear Physics Tools                              | 194        |
| 4.6.9 Summary and Recommendations   | 197        |
| <hr/>   |            |
| <b>5. Annexes</b>   | <b>199</b> |
| 5.1 Contributors  | 201        |
| 5.2 NuPECC Committee  | 202        |
| 5.3 Acronyms and Abbreviations  | 203        |



# Foreword

---

The goal of this European Science Foundation Forward Look into the future of Nuclear Physics is to bring together the entire Nuclear Physics community in Europe to formulate a coherent plan of the best way to develop the field in the coming decade and beyond.

The primary aim of Nuclear Physics is to understand the origin, evolution, structure and phases of strongly interacting matter, which constitutes nearly 100% of the visible matter in the universe. This is an immensely important and challenging task that requires the concerted effort of scientists working in both theory and experiment, funding agencies, politicians and the public.

Nuclear Physics projects are often “big science”, which implies large investments and long lead times. They need careful forward planning and strong support from policy makers. This Forward Look provides an excellent tool to achieve this. It represents the outcome of detailed scrutiny by Europe’s leading experts and will help focus the views of the scientific community on the most promising directions in the field and create the basis for funding agencies to provide adequate support.

The current NuPECC Long Range Plan 2010 “Perspectives of Nuclear Physics in Europe” resulted from consultation with close to 6000 scientists and engineers over a period of approximately one year. Its detailed recommendations are presented on the following pages. For the interested public, a short summary brochure has been produced to accompany the Forward Look.



**Professor Marja Makarow**  
Chief Executive  
European Science Foundation

A handwritten signature in black ink that reads "Marja Makarow". The signature is written in a cursive style.



**Professor Günther Rosner**  
Chair of the Nuclear Physics  
European Collaboration Committee

A handwritten signature in black ink that reads "G. Rosner". The signature is written in a cursive style.





# 1. Executive Summary

---

## 1.1 Outline

The goal of this Forward Look on European Nuclear Physics, or NuPECC Long Range Plan, is to bring together the Nuclear Physics community in Europe, which presently numbers ca. 6000 scientists and engineers, to discuss and formulate a visionary and coherent long-term plan for the future development of the field in the next decade and beyond.

Specifically, we:

- Review recent achievements and the current state of the art in Nuclear Physics.
- Identify open problems and hot topics.
- Develop medium and long-term strategies to tackle them.
- Identify synergies with other fields and future applications.
- Develop a European perspective and put it into a worldwide context.
- Formulate recommendations and propose a concrete plan of action.
- Present a roadmap for upgrading existing, and building new, powerful Nuclear Physics facilities in Europe.

### 1.1.1 Scientific Scope

The scientific scope of this Forward Look is to advance the case for:

- Studying the fundamental strong interaction (as described by Quantum Chromodynamics) that holds hadrons such as protons and neutrons together. Investigations of hadron internal structure and spectroscopy require both lepton (electron, positron and muon) on hadron and hadron on hadron scattering facilities as a tool.
- Better understanding the strong interaction by studying the phase-diagram of matter that primarily interacts via the strong force. Relativistic heavy ion beam facilities are the tools needed for such studies.
- Investigating the structure of nuclei far from stability by using, in particular, radioactive heavy ion beams produced by both in-flight fragmentation and Isotope Separator On-Line, ISOL, techniques. In addition, the capabilities of high-intensity stable heavy ion beam facilities should be further improved, and plans should be developed for upgrading or building new small-scale accelerators dedicated to nuclear astrophysics.
- Studying key aspects of fundamental interactions and symmetries using nuclear physics techniques, e.g. investigations of matter-antimatter symmetry, the nature of the neutrino, and precision measurements of weak interactions. This will require new sources of low-energy antiprotons, improved underground laboratories, and access to upgraded and new facilities producing exotic nuclei.

- Developing advanced theory methods to answer the key questions addressed by experimental programmes and to establish a link of nuclear properties with Quantum Chromodynamics. Such a programme requires a large and coherent international theory effort and collaboration between nuclear theorists, experimentalists, computer scientists and applied mathematicians.
- Further supporting the development of applications of Nuclear Physics in areas ranging from energy production to nuclear medicine and security, and advancing smaller-scale facilities across Europe that vitally support and complement physics projects at the large-scale facilities and are of paramount importance for training and education in Nuclear Physics.
- Supporting longer term Nuclear Physics projects such as PAX, the ENC and EURISOL. These will significantly improve our knowledge of the structure of the nucleon and of nuclei right out at the neutron drip-line. In addition, we recommend supporting the plans for establishing Nuclear Physics programmes at the multi-purpose large-scale facilities ELI and ESS.

### 1.1.2 Societal Scope

Paying tribute to its cultural heritage, Europe should continue to be at the forefront of promoting one of the most vigorous and fascinating fields in basic science, Nuclear Physics. Nuclear physics addresses the fundamental aspects of those particles that interact via the strong interaction. These hadrons constitute nearly 100% of the visible matter in the universe.

With the renewed worldwide interest in nuclear technology (low-carbon energy: nuclear fission and nuclear fusion power generation, nuclear medicine: imaging and tumour therapy, security, materials studies with nuclear probes, etc.), Europe needs to preserve, and even enhance, its nuclear physics knowledge and skills basis in the future. A dedicated effort directed at the training of young people is mandatory. A rigorous applied Nuclear Physics programme requires to:

- Acquire new nuclear data for use in novel fission and future fusion reactors.
- Develop new particle accelerators for use in nuclear physics and cognate fields as well as for cancer therapy.
- Design new radiation sources and detector systems for security.
- Design new detectors and electronic readout systems for medical imaging.
- Develop the nuclear physics tools (particle accelerators, detector systems, simulation codes) for increasingly precise materials studies.
- Apply nuclear physics methods in the humanities (archaeology, art analysis, restoration and dating).

# 1. Executive Summary

---

## 1.1.3 Objectives

The objectives of the current NuPECC Long Range Plan are:

- To review the status of the field in Europe and put it in a worldwide context.
- To formulate recommendations for developing nuclear science and its applications in the next decade and beyond.
- To agree upon an action plan and propose a roadmap for the upgrade of existing facilities and the construction of new large-scale facilities.
- To synchronise the new action plan at European level with e.g. the EU FP7 ERA-net “NuPNET” of funding agencies, taking into account developments at the global level in America and Asia.

## 1.1.4 Forward Look

The present Forward Look or Long Range Plan **Perspectives of Nuclear Physics in Europe**, as initiated and carried through by the Nuclear Physics European Collaboration Committee, NuPECC, addresses the perspectives and plans for nuclear physics in the period from 2010 to approx. 2025, and attempts to identify the most important areas for future developments.

The document includes a set of recommendations and a road map for major activities, new facilities and tools for both experiment and theory that are intended to help funding agencies, decision makers, politicians and also the European nuclear physics community in planning and shaping the future ahead in the most enlightened, effective and productive way.

The NuPECC recommendations and proposed road map are based on the work of six expert working groups (WGs), whose membership was drawn from the wider nuclear physics community in Europe. The NuPECC Long Range Plan 2010 (LRP2010) was discussed at several mini-workshops of the respective working groups. Two town meetings (Scoping Workshop in 2009 and Consensus Conference in 2010 under the Spanish EU presidency) were open to all members of the nuclear physics community. Hence, the LRP2010 represents a clear majority view of the major issues in the field and of the major steps to be taken in the future.

The working groups were asked to examine the following major Nuclear Physics areas: Hadron Physics, Phases of Strongly Interacting Matter, Nuclear Structure and Dynamics, Nuclear Astrophysics, Fundamental Interactions, and Nuclear Physics Tools and Applications.

In the following sub-sections of the Executive Summary, we present the “big picture”, a summary of

the status of nuclear research infrastructures in Europe, plans to upgrade them or build new ones in the next one or two decades, collaborations at European and global level, and brief summaries of each of the major scientific themes.

## 1.2 The Big Picture

Nuclear physics is the science of the atomic nucleus and of nuclear matter. The atomic nucleus is the dense core of the atom and is the entity that carries essentially all the mass of the familiar objects that we encounter in Nature, including the stars, the Earth and indeed human beings themselves.

Atomic nuclei consist of two types of particles, the electrically charged proton and the neutron, which has no charge. Varying numbers of protons and neutrons aggregated together form the elements of the periodic table, and by binding negatively charged, much lighter electrons around them form atoms. The atoms can, in turn, combine and form molecules making complex chemical and biological structures. The largest and heaviest nuclei contain up to nearly 300 protons and neutrons (collectively called nucleons).

The constituents of nuclei are, however, not elementary. Following intensive research efforts throughout the latter third of the 20<sup>th</sup> century, it is now known that protons and neutrons have a substructure: they are composed of point-like particles called quarks. The quarks interact and are ‘glued’ together through the strong force, one of the four known forces in Nature.

The strong force is mediated by gluons, which have the unusual property of being able to interact with themselves, in contrast to the carriers of the other known forces. This is due to a property called colour, which has surprising and fundamental consequences: It is not possible to free quarks from their ‘confinement’ inside the nucleons. The strong force also binds the nucleons of the atomic nucleus together, although the binding between the nucleons is not mediated by the gluons directly, but indirectly by the exchange of more complex particles (mesons).

We have good grounds to believe, today, that quarks and gluons aggregated to form nucleons in the first moments after the Big Bang that created the Universe, taking only about one millionth of a second. About 3 minutes later, when the Universe had cooled sufficiently, protons and neutrons were able to bind and form the first light nuclei, which subsequently captured electrons and formed atoms.



---

On a time scale of hundreds of millions of years, light atoms lumped together under the influence of gravity and formed the first stars. In their hot interior, nuclear processes took place that built up heavier nuclei and freed large amounts of energy, just as they do in the interior of our Sun today. In violent supernovae, explosions of particularly massive stars, the very heavy elements that we encounter on Earth today were produced in a complex series of fast nuclear reactions.

It is remarkable that, had some of the values of the fundamental physics constants or the properties of the nucleons or of nuclei only slightly been different, the present Universe might not exist. Nuclei constitute a unique test bed for a variety of investigations of fundamental physics, which in many cases is complementary to elementary particle physics approaches.

Humankind has been able to piece together this fascinating tale of our beginnings and of our present world by studying the properties of atomic nuclei in laboratories on Earth and using this knowledge to infer what happens beyond our own confined existence.

The necessary tools to do this are:

- Powerful accelerators that can create new particles or synthesise complex nuclei, break nuclei apart or probe the interior of nucleons and nuclei.
- Advanced detectors that can register the fragments of hadronic or nuclear reactions and the radiation that is emitted when nucleons or nuclei are excited to higher energy levels.
- An ever-deepening theoretical understanding of the complex processes involved, often coupled to innovative and high-performance computer simulation techniques that also find applications in other areas of science.

It is clear from the short narrative given above that the physics of atomic nuclei and of their constituents is rich, varied, and extremely complex at many levels. For example, the fundamental theory of the strong interaction, called Quantum Chromodynamics (or QCD, for short), is able to describe quantitatively features pertinent to quarks and gluons only at very high energies, where perturbative calculation methods are applicable. At lower energy scales, QCD is still not able to explain in detail how dense systems of quarks and gluons behave, how the confinement of quarks in hadrons such as protons or neutrons operates, how the spin structure of nucleons evolves, how they bind, and how complex many-body quantum mechanical systems such as nuclei behave.

A thorough and comprehensive understanding requires a continued large effort at the experimental level exploring in detail new types of reactions over a wide range of energies and unravelling the complex hadronic and nuclear

many body systems, developing a more fundamental theoretical framework based on effective field theories, constructing efficient phenomenological models of nucleons and nuclei, and devising new and precise simulation tools. Indeed, we still do not have a “standard model” for Nuclear Physics, i.e. a framework that allows the reliable description of hadronic and nuclear phenomena over all relevant energy scales from first principles.

Apart from contributing importantly to our basic understanding of Nature and thus to our self-perception and cultural framework at all levels, Nuclear Physics is also contributing significantly to society in practical terms through a multitude of applications and methods ranging from energy production to cancer therapy using nuclear particle beams.

## 1.3 Research Infrastructures and Networking

Nuclear Physics in Europe is a vibrant field of basic and applied sciences – competitive at a global level – not least because it is well equipped with a network of large and smaller scale facilities that collaborate closely in the framework of NuPECC (European Science Foundation, ESF), the Integrating Activities “HadronPhysics2”, “ENSAR” and “SPIRIT”, and the ERA-net “NuPNET” of the EU Framework Programme (FP) 7. In addition, NuPECC has provided input to the European Strategy Forum on Research Infrastructures, ESFRI. In fact, Nuclear Physics might be taken as a case in point where the three centres of gravity of the European Research Area, ERA, that is the European Science Foundation (national funding agencies), the European Strategy Forum on Research Infrastructures (national science ministries), and the European Commission, are acting collectively and very efficiently to initiate and support the building of new large-scale research infrastructures in a particular field of the European Research Area.

### 1.3.1 Current Research Infrastructures and Upgrades

There are several different ways of classifying the existing Nuclear Physics facilities in Europe, according to their objects of study (hadrons, nuclei, applications), the probes that are used to investigate them (lepton/photon or hadron/heavy ion beams), or simply by the size of the facility. None of these classifications is unique, because most laboratories are active in several, or all, of the above fields and use a variety of probes. Still, smaller scale facilities often concentrate on low-energy nuclear

# 1. Executive Summary

---

structure and astrophysics, fundamental interactions or applications.

In the figure on page 9, an overview of the major nuclear physics laboratories in Europe is given, where we have chosen to highlight (in yellow) those large-scale facilities that applied for transnational access funds in FP 6 or 7 in “HadronPhysics”, “EURONS”, “HadronPhysics2” and “ENSAR”. The smaller scale facilities (in red) are members of Networks or Joint Research Activities in “ENSAR”, or provide transnational access in “SPIRIT”.

The large-scale facilities that use lepton (electron/positron or muon) or real photon probes to investigate primarily the structure and spectroscopy of hadrons such as protons or neutron are (in strictly north to south order): MAX-lab in Lund, ELSA in Bonn, MAMI in Mainz, COMPASS at CERN and DAΦNE at INFN Frascati. All have limited-size upgrade programmes to either increase the beam energy (at MAMI) or beam intensity (at DAΦNE) or upgrade their large experimental setups (at ELSA and COMPASS).

Hadron beam facilities fall into two categories, those that use protons, anti-protons, pions or kaons, and those that use heavy ions. The first group of laboratories (COSY at FZ Jülich, GSI, the Antiproton Decelerator, AD, at CERN, and DAΦNE at INFN Frascati) concentrate on the study of hadron structure and spectroscopy, the interaction between individual hadrons or their modification in the dense nuclear medium, and the investigation of fundamental interactions and symmetries. At DAΦNE, kaonic atoms are being investigated in addition. COSY has recently been upgraded by transferring the WASA detector from Uppsala to Jülich, and DAΦNE has increased its luminosity by an order of magnitude.

The by far largest number of Nuclear Physics laboratories operate heavy ion accelerators, whose beam energies range from MeV to TeV. Consequently, they are used to tackle very different problems in the field.

At lower incident energies, these are chiefly nuclear astrophysics problems, fundamental interactions or applications of nuclear methods in, e.g., materials science, accelerator mass spectrometry, biomedical sciences, nuclear medicine, environmental sciences and cultural heritage studies. As previously mentioned, these studies are performed mainly at smaller-scale facilities spread across nearly all NuPECC countries. One of these experiments, LUNA, takes place at the INFN Gran Sasso underground laboratory.

At medium energies, nuclear structure studies, often under extreme conditions, and the investigation of the dynamics of nuclear reactions are of primary interest. The experiments are performed either by using high-intensity stable beams or, since recently, the first radioactive

beams. Prime examples of such laboratories are (in north to south order): JYFL in Jyväskylä, KVI in Groningen (concentrates on fundamental interactions), GSI in Darmstadt, GANIL at Caen, ALTO at IPN Orsay, ISOLDE at CERN, and the INFN laboratories in Legnaro and Catania.

At the TeV centre-of-mass energies of the ALICE experiment at LHC/CERN, a change of paradigm is anticipated. Nucleons and mesons are no longer expected to be the relevant degrees of freedom in “nuclear matter” at such high energies. Rather it is expected that a new state of matter will form: a plasma, where chiral symmetry, a fundamental symmetry of Quantum Chromodynamics, is restored and quarks and gluons are no longer confined in hadrons. Data taking has just started at ALICE, and the collaboration is actively planning for upgrades of their large-scale experiment in the future.

Two theoretical Research Infrastructures have been included in the network of Nuclear Physics facilities. Those are ECT\* at Trento and the high-performance computer centre, JSC, at FZ Jülich. Whilst ECT\* has a broad remit to support education and foster new theoretical approaches in the field, JSC has been instrumental in performing large-scale lattice QCD calculations in hadron physics and effective field theory calculations in nuclear structure physics.

## 1.3.2 Future Research Infrastructures

There are a number of major routes forward for Nuclear Physics. One is to study the detailed three-dimensional structure of nucleons or, more generally, hadrons and their spectroscopy; another one is to explore nuclei under extreme conditions, e.g. at the boundaries of nuclear existence, and the (cataclysmic) astrophysical processes that lead to them; a third one is to investigate strongly interacting matter at very high energies. All these routes require powerful new accelerator facilities.

Two such facilities have recently been founded, the Facility for Antiproton and Ion Research, FAIR, at the GSI site in Darmstadt and SPIRAL2 at the GANIL site in Caen. Both projects had previously been included in the ESFRI list of European large-scale research infrastructures and supported by EU FP 6 and 7 Design Studies and Preparatory Phase funding. Their first construction phases are planned to be completed by 2016 and 2014, respectively.

FAIR features four strands of research, hadron physics experiments with anti-proton beams (PANDA experiment), nuclear structure studies at the extremes with intense radioactive beams produced in-flight at a fragment separator (NuSTAR experiments), compressed baryonic matter investigations (CBM collaboration), and experiments in plasma physics, atomic physics (also



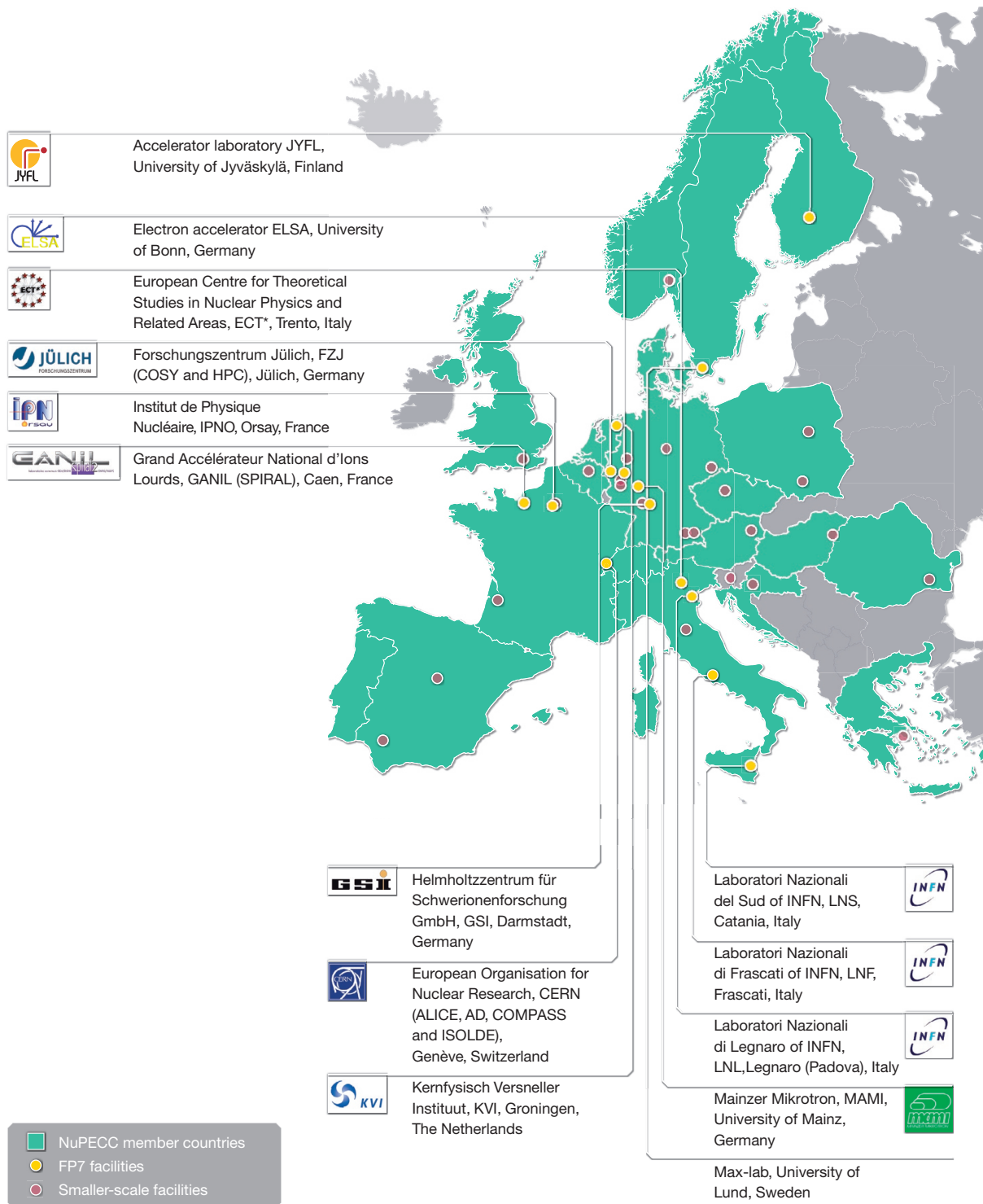

Current Nuclear Research Facilities in Europe.

# 1. Executive Summary

---

using slow anti-protons), medical physics and biology, and space science (APPA collaborations).

At SPIRAL2, an alternative approach to producing radioactive beams will be used. Rather than fragmenting high-energy projectiles directly, the Isotope Separation On-Line, ISOL, method will be applied, where radioactive species are produced by bombarding uranium with high-energy neutrons and post-accelerating the fission fragments.

Both methods, the in-flight fragmentation and the ISOL production of radioactive beams, are complementary with respect to their capabilities of producing different highly unstable nuclei, and both need similar types of highly sophisticated detectors such as the travelling gamma-ray spectrometer.

Major upgrades of two existing heavy ion accelerators are planned at CERN and INFN Legnaro. Both HIE-ISOLDE at CERN and SPES at Legnaro will be advanced ISOL radioactive beam facilities. Together with SPIRAL2, they will pave the way for the ultimate high power ISOL facility EURISOL, whose conceptual design was supported via a Design Study in the EU Framework Programme 6, and should be included in the next edition of the ESFRI list.

Since radioactive beam intensities are small, long beamtimes are needed. With the anticipated approval of the Accelerator Driven subcritical Reactor, ADS, project MYRRHA in Mol and its inclusion in the ESFRI list, there will be an opportunity to install the ISOL@MYRRHA experiment, which could provide ample beamtime during the scheduled downtimes of the ADS.

There are two other multi-purpose ESFRI projects that offer opportunities for nuclear structure research, the Extreme Light Infrastructure, ELI, and the European Spallation Source, ESS. Whilst the plans for nuclear physics installations at the ELI branch in Bucharest are in an advanced state, the use of ESS for nuclear physics purposes still needs to be explored in more detail.

Concerning hadron physics, there are three collider projects in Europe that point further into the future.

The Polarized Antiproton eXperiment, PAX, and the Electron Nucleon Collider, ENC, are potential future upgrades of FAIR. Both would use the High Energy Storage Ring, HESR. ENC would in addition make use of the PANDA detector and hence could be set up at a very reasonable cost. The PAX experiment aims at unravelling the nucleon's structure by colliding polarised antiprotons with polarised protons. The ENC would scatter polarised electrons on polarised protons or light ions to measure exclusive reactions at much higher centre-of-mass energies than were available at DESY. The physics programme

aims at determining Generalised Parton Distributions, which will provide a three-dimensional picture of the nucleon.

The Large Hadron electron Collider project, LHeC, at CERN is driven by the European particle physics community, but has important implications for high-energy nuclear physics as well. High-energy electrons colliding with high-energy heavy ions will probe the gluon density at extremely small momentum fractions, where theory predicts gluon saturation effects. Since matter essentially consists of glue, a detailed understanding of its distribution is of prime importance.

### 1.3.3 Collaboration at European and Global Level

The ambitious experimental and theoretical programme in Nuclear Physics, briefly outlined above and described in more detail in subsequent sections, would not be possible without close collaboration at European and international level.

There are several types of collaboration common in the field. Since nearly all nuclear physics facilities apply an open access policy that is only controlled by Programme Advisory Committees who assess the quality and feasibility of the proposed experiment, funding is one of the main issues. In this context, the EU's Framework Programmes supporting transnational access to European large-scale nuclear physics laboratories for groups from less well off countries are very instrumental.

Big projects need elaborate planning, strong support of the whole community, coordination with cognate fields and, most importantly, the support of research councils and science ministries.

In this context, NuPECC has been active as an expert committee of the European Science Foundation (research councils) by focusing the views of the nuclear physics community in Europe (ca. 6000 scientists and engineers) onto Long Range Plans, submitting roadmaps to ESFRI (science ministries) and initiating EU Framework Programme projects (Integrating Infrastructure Initiatives, Integrating Activities and an ERA-net). There are cross memberships with sister organisations in Europe (Nuclear Physics Board, NPB, of the European Physical Society, EPS), the USA (NSAC) and Asia (ANPhA) to coordinate regional large-scale nuclear physics projects.

At a global level, NuPECC represents Europe on the Working Group WG.9 on International Cooperation in Nuclear Physics of the International Union of Pure and Applied Physics, IUPAP, and contributes to the OECD Global Science Forum working group's reports on Nuclear Physics.

---

## 1.4 Scientific Themes

In the following sub-sections, we introduce each of the main scientific topics and the major directions within them. We refer the interested reader to a more comprehensive treatment in the subsequent chapters.

### 1.4.1 Hadron Physics

Hadrons are strongly interacting, composite particles made from so-called “current quarks” and gluons, the point-like elementary building blocks of QCD. Neither quarks nor gluons have ever been seen in isolation. Instead, they are confined inside hadrons in special ‘colour neutral’ combinations. Baryons such as the familiar nucleons of nuclei, the proton and the neutron, each consist of three so-called “constituent quarks”. Other hadrons consisting of a quark and an anti-quark form mesons. The lightest meson, the pion, is responsible for the long-range part of the interaction between nucleons and plays a major role in the binding of the nucleons inside the nucleus.

Open key questions in hadron physics are:

- How does the strong interaction confine quarks and gluons into hadrons?
- What precisely is the internal structure of hadrons in terms of fundamental quarks and gluon degrees of freedom?
- What is the role of quarks and self-interacting gluons in nuclei?

The constituent quark picture provides a simple classification scheme for organising the various hadronic species. In spite of its deceptive simplicity, this picture is however far from complete. The mass of the current quarks that comprise the nucleon is very small (about one percent of the proton mass). This gives rise to an (approximate) symmetry in QCD, known as chiral symmetry. Due to the very strong interaction between quarks and gluons at small energy scales, chiral symmetry is spontaneously broken (much like the breaking of rotational symmetry in a magnet). Via this mechanism, constituent quarks receive their mass of several hundred MeV and the pion emerges as a (nearly) massless excitation of the non-trivial QCD vacuum. These ‘Goldstone bosons’ form the basic building blocks of a low-energy theory for QCD, which is widely used in the description of the large-distance properties of hadrons, their mutual low-momentum interactions, and more recently also nuclear structure physics.

We now know that the internal structure of hadrons is far richer than previously thought. Indeed, their description depends on the resolution scale of the experimental probes. Whilst at low resolution, baryons and mesons

emerge as objects governed by the dynamics of broken chiral symmetry, high-resolution experiments reveal a structure containing a multitude of pairs of quarks and anti-quarks of different types (flavours) and a host of gluons, revealing the elementary degrees of freedom of QCD.

QCD describes the strong-interaction sector of the Standard Model of elementary particles. In contrast to electro-magnetism, the force carriers (gluons) self-interact, which renders the theory intrinsically non-linear. In the high-energy regime, the interaction between quarks and gluons can be described by perturbation theory, much like the interaction between electrons and photons in Quantum Electrodynamics. This is because the interaction strength weakens with increasing energy (or shorter distances) due to a mechanism called ‘asymptotic freedom’. The perturbative treatment of the interaction processes, however, starts to fail when the distance between quarks becomes comparable to the size of the nucleon. In this case, the interaction becomes so strong that very complex phenomena emerge, which are for instance being investigated in electron/positron/muon-scattering experiments on nucleons at MAMI in Mainz, ELSA in Bonn, HERMES at DESY, COMPASS at CERN and Jefferson Lab (JLab) in the US.

From such experiments, one can obtain ‘snapshots’ of the internal structure. Depending on the energy of the projectile, such snapshots provide position or momentum distributions of the quarks inside a hadron. However, a consistent description of hadron properties, such as their spin, has still to be achieved from the measured photon or particle distributions. This will be studied in future experiments at the upgraded COMPASS and Jefferson Lab facilities, or new lepton scattering research infrastructures such as the proposed Electron-Nucleon-Collider, ENC, at FAIR or the Electron-Ion-Collider, EIC, at either Brookhaven National Laboratory, BNL, or JLab. In addition, it is realistic to expect that new theoretical approaches, in the framework of Generalised Parton Distributions for example, will lead to a real ‘hadron tomography’.

In responding to the first two key questions above, hadron spectroscopy has played a prominent role at DAΦNE at LNF, COSY, MAMI, ELSA and JLab. Whilst the large set of excited hadrons discovered in spectroscopy experiments is clear evidence for quark degrees of freedom, unexpected spectroscopic results at e.g. BELLE have recently challenged the picture of hadrons being composed of quark-antiquarks or three quarks only. They indicate a much more complex structure of perhaps multiquark or quark molecule character. One of the most promising experiments to search for these exotic hadrons in the future will be PANDA at FAIR.

# 1. Executive Summary

---

The role of gluons in the formation of complex particles is still mostly unknown. We do know that gluons played a major role in the development of the Universe when, microseconds after the Big Bang, quarks coalesced into hadrons and there was an associated generation of mass. Furthermore, the self-interaction of gluons is crucial in the description of confinement. According to QCD, it should be possible to form hadrons that consist of gluons only, commonly termed ‘glueballs’. It is also conceivable that hybrid systems exist, composed of a combination of quarks and gluonic excitations. Future experiments, primarily at PANDA at FAIR, but also at GlueX at the upgraded Jefferson Lab, should reveal such gluonic states by searching for exotic hybrid mesons or glueballs.

Since QCD is non-perturbative at large distance scales, theoretical tools other than perturbation theory are required for a quantitative understanding of hadronic properties. One such tool is large-scale numerical computation of observables such as hadron masses and decay probabilities on a discrete space-time lattice. Much progress has recently been made in linking the numerical results to experimental observations, but we are still far from understanding the complete hadron spectrum from such first-principles calculations. A second tool, which does not suffer from discretisation artefacts and uncertainties in extrapolations to the space-time continuum, is the use of non-perturbative resummation schemes of QCD correlation functions.

Related to the third question, the interactions of quarks within nuclei can uniquely be studied by implanting identifiable probes inside a nucleus. Heavier quarks such as strange or charm quarks, which are usually not present inside nuclear matter, allow detailed studies of quark degrees of freedom inside nuclei. Until now, hypernuclear experiments have suffered from low statistics. New experimental approaches at e.g. PANDA and CBM at FAIR, or J-PARC in Japan will improve the current sensitivity by many orders of magnitude. This will open new horizons in this field and extend the nuclear chart into a third (strange) dimension.

## 1.4.2 Phases of Strongly Interacting Matter

Nuclear matter, that is, the matter of which nuclei are formed, either at the level of nucleons or at the level of their constituents, quarks and gluons, exists in many forms depending on the energy (or equivalently, temperature scale) at which it is observed.

At very low energies, nuclei are stable quantum mechanical assemblies consisting of hadrons (protons and neutrons) with properties reminiscent of liquids. At slightly higher energies, the nucleons can no longer

remain bound and nuclei dissociate into a gas of hadrons. At still higher energies, for example in the range relevant for experiments with the Large Hadron Collider, in recreation of the conditions prevailing in the very early Universe, nuclear matter is decomposed into a liquid or gas of elementary particles (the quarks and the gluons), the quark-gluon plasma, QGP. The three enumerated states of nuclear matter outline the principal phases of nuclear matter, although many new and more detailed aspects predicted by the theory of the strong interaction still lie uncovered.

It is one of the central challenges of modern day physics to establish, understand from experiment and be able to calculate from basic theory, the phase diagram of nuclear matter including the transitions between the various phases. The details of the diagram are entirely governed by the strong force, whose detailed properties are still poorly understood, although very significant progress has been made in the last decade. The (still) exotic phase diagram of nuclear matter has its parallel in the more commonly known diagram of the phases of ordinary matter (for example water, which exists as ice, liquid or vapour), which is governed by electromagnetic forces and is decisive for life.

The implications of fully understanding the strong force are still unknown, although the potential societal perspective may perhaps be best anticipated by citing 19<sup>th</sup> century physicist Michael Faraday, who upon being asked by prime-minister Gladstone, what use this (electricity) would have, replied: ‘Why, sir, there is every possibility that you soon will be able to tax it’.

Some of the crucial questions are:

- What are the fundamental properties of strongly interacting matter as a function of temperature and density?
- How do hadrons acquire their mass and how is the mass modified by the medium they move in?
- What are the properties of the quark gluon plasma?
- Are there colour superconductors and highly dense gluonic objects in Nature?

At the highest energies, in a range made accessible to experiment by the RHIC accelerator in the USA and the Large Hadron Collider (LHC) in Europe (which will provide an increase in energy of a factor of 30 over RHIC), nuclear matter appears as a state consisting of quarks and gluons in the form of a plasma. The plasma state is one in which the characteristic constituents, which for the strong interaction are entities bearing the property called colour, are no longer confined in bound states. Central themes in the study of the QGP are the exploration of the properties of the QGP phase and the understanding of the transition to a phase in which quarks and gluons are trapped (confined) in hadrons.



---

At RHIC, the quark and gluon phase has been identified with a strongly interacting liquid with properties close to those expected for a perfect fluid. However, at LHC energies the QGP may behave more like a gas of non-interacting, or weakly interacting, particles.

Research at the LHC, using the large dedicated detector ALICE for the study of energetic nucleus-nucleus collisions may push our experimental understanding of the QGP back to about a nanosecond (one billionth of a second) after the Big Bang. Central questions are connected to understanding the symmetry breaking mechanisms that determine the properties of various phases, for example the masses of quarks and the masses of hadrons, via chiral symmetry breaking. Symmetry breaking is central to a wide class of problems in all areas of physics. The experimental programme with ALICE at the LHC has just started and it is a central priority that the long-term continuity of the programme is assured with a variety of beams and detector upgrades to provide unique new fundamental physics information over the next decade or longer.

At lower energies, in a region experimentally accessible to experimental studies with the facilities SPIRAL (France) and FAIR (Germany), a transition between a gaseous state of hadrons and the nucleus itself occurs. Research over the last decade has evidenced the nature of this Liquid-Gas (LG) transition as a first order transition, predicted to connect to a second order critical point. Important correlations occur in the dilute gaseous phase that may prove to be central for understanding the phase transitions occurring in the cores of Supernovae and in the crust of neutron stars.

The strong interaction may lead to new and yet undiscovered features of the phase diagram connected, for example, the possibility of producing very dense hadronic matter in nuclear collisions. For systems at moderate temperature but very high density, as encountered in the interior of neutron stars, new states of matter may be realised with properties of (colour) superconductors. Research in this area will be made possible primarily through the new FAIR facility at GSI (Germany) and the proposed Compressed Baryonic Matter (CBM) detector.

Theoretically, the study of the complex strongly interacting nuclear many body system at medium or very high temperatures poses deep challenges. One approach, still in development, is based on extensive numerical first principle calculations on a lattice using the fundamental theory of the strong interactions (so-called Lattice QCD calculations). Other approaches focus on the study of the collective behaviour of the studied systems by using methods from thermodynamics. In all cases, future theoretical developments will require strengthening to follow

with rapid experimental advances and access to high performance computing.

Finally, interesting prospects arise connected with the fascinating possibilities of studying the gluonic content of nucleons or nuclei at low temperature but using very high probe energies. Indeed, recent advances have suggested that due to the unique property of the force carriers of the strong interaction, the gluons, a gluon condensate may exist in nuclei that can be probed experimentally. Such a state would be a parallel to the Bose-Einstein condensates that are studied vigorously in other areas of physics, but in this particular case one that is governed by the strong interaction. Such studies may come about via the construction in Europe of dedicated high-energy electron-nucleus colliders, such as the proposed LHeC accelerator at CERN.

### 1.4.3 Nuclear Structure and Dynamics

Atomic nuclei constitute a remarkable laboratory to observe quantum many-body effects and to test many-body approaches. Individual nucleons interact through the influence of the strong and the electromagnetic forces and nuclei contain a limited number of constituents (from one up to about 300). Nuclei exhibit all the features of complex many-body systems.

Nuclear properties exhibit a remarkable duality. Many macroscopic properties can be understood by concepts similar to those used to describe droplets of fluid, whilst the motion of individual nucleons moving in an effective potential (mean field) created by all the nucleons gives rise to properties which do not vary smoothly with nucleon number. The motion of individual nucleons in the nucleus may polarise it thus leading to major rearrangements of the ensemble. One of the major present day challenges is to investigate and understand how the additional correlations that go beyond a mean field description can bridge the gap between the two concepts leading to a unified description.

The exploration of bound nuclear systems proceeds on many fronts, employing a wide variety of experimental and theoretical techniques. These range from the study of individual excitations and nucleonic rearrangements to the understanding of collective modes of motion (vibrations and deformations). The conceptual foundation of nuclear structure theory is low-energy Quantum Chromodynamics (QCD) that describes the structure of nucleons in terms of quarks and their mutual interaction. Over the past decade, nuclear structure theory has started to exploit the link to QCD in a quantitative way. Using specific tools based on the symmetries and the relevant degrees of freedom of QCD, *ab initio* methods have been developed. A major challenge is to extend, starting

# 1. Executive Summary

---

from the few-body systems, the range of application of *ab initio* many-body methods to describe properties of nuclei with increasing numbers of nucleons.

Attempts are being made to establish the limits of nuclear existence with respect to disintegration by fission (quest for superheavy elements) and with respect to the binding of individual nucleons (drip lines and dilute halo systems). Important nuclear reaction probabilities are determined for fields as diverse as astrophysics and the transmutation of nuclear waste. It is estimated that more than 8000 nuclei may remain bound, with only about a quarter of these having been identified. Nuclear behaviour is expected to be significantly altered in the yet unexplored regions. Some of the key questions today are:

- How can we describe the rich variety of low-energy structure and reactions of nuclei in terms of the fundamental interactions between individual particles?
- How can we predict the evolution of nuclear collective and single-particle properties as functions of mass, iso-spin, angular momentum and temperature?
- How do regular and simple patterns emerge in the structure of complex nuclei?
- What are the key variables governing the dynamics between colliding composite systems of nucleons?

A central challenge in present-day nuclear structure physics is the understanding of exotic nuclear states and exotic nuclei very far from the line of stability, the latter comprising the small number of naturally occurring stable nuclear isotopes. Such exotic nuclei play an important role in the sequence of reactions that form the heavier stable nuclei that can be found on our planet. Significant efforts are being taken to make inroads into this uncharted territory by developing new techniques and accelerator facilities to produce beams of unstable isotopes, so-called rare isotope or radioactive beams (RIBs, e.g. at SPIRAL2, FAIR and on the more distant horizon at the proposed EURISOL facility). In this connection, nuclear reactions play a major role and therefore further developments of reaction theory and connections with nuclear structure, possibly microscopic and *ab initio*, should be an important aspect for future investigations.

The realisation of this programme requires the availability of both RIB and stable-ion beam (SIB) facilities, along with the development of new experimental techniques and instrumentation. New dedicated facilities delivering high intensity heavy ion beams are needed for the synthesis of new super-heavy elements and to investigate their properties. Several smaller accelerator facilities are also essential for specific experiments requiring long beam times or for developing and testing of new instruments. This will ensure that experiments are

carried out on many fronts by a large user community, and, very importantly, will provide training to the next-generation researchers.

Many of the most important experimental results on nuclear structure and reactions with RIBs originated from the European first generation of RIB facilities at GANIL (France), GSI (Germany) and ISOLDE (CERN). There are two complementary methods to produce RIBs: in-flight separation and the ISOL approach. The next generation RIB facilities in Europe build on these principles. The major in-flight project is FAIR (NUSTAR) at GSI, the major ISOL project is SPIRAL 2 at GANIL, both of which are on the ESFRI list.

An upgrade of ISOLDE to HIE-ISOLDE has very recently been endorsed by the CERN Research Board. SPIRAL2, HIE-ISOLDE and the SPES- facility at LNL are due to come on-line in 2013-2015. SPIRAL2 will deliver the most intense beams of neutron-rich nuclei produced by secondary fast-neutron induced fission, as well as products of other reactions induced by high-intensity heavy ion beams. HIE-ISOLDE will provide proton-rich and neutron-rich products of reactions induced by 1.4 GeV protons, giving for example a unique source of exotic heavy nuclei produced by spallation reactions. SPES will produce beams of fission products following direct proton bombardment of uranium targets. These facilities will together produce accelerated beams of a wide and complementary range of radionuclides as demanded by the future science programme. They will be intermediate-stage ISOL projects that bridge the technological gap between present day facilities and EURISOL, the next generation ISOL facility for Europe for 2020 and beyond.

Advanced instrumentation plays a major role in the future programmes. Novel radioactive and cryogenic targets are required for many studies. Combined with the Super Fragment Separator (Super-FRS) at FAIR, R3B is a next generation device, which will provide kinematically complete reaction data with relativistic RIBs. The Advanced GAMMA Tracking Array, AGATA, will represent a breakthrough in instrumentation for gamma-ray spectroscopy. This will be the first  $4\pi$  gamma-ray spectrometer built solely from Ge detectors and allowing gamma-ray tracking. The technique will undoubtedly find extensive practical applications in other domains, such as medical imaging. A wide range of magnetic spectrometer systems at European accelerator laboratories will be ready to be combined with AGATA. It will be a key instrument in RIB experiments at FAIR-NUSTAR, SPIRAL2 and SPES. The availability of ion traps of increased sensitivity will also play a key role when extending accurate mass measurements towards the production limits of exotic nuclei.

---

Advanced theory methods play a central role in answering the key questions of nuclear structure. Dedicated, increased and sustained efforts will be needed to improve the collaboration between theoreticians and experimentalists. A strong transnational programme should also be undertaken to develop theory models incorporating recent advances made in the construction of realistic nucleon-nucleon interactions.

#### 1.4.4 Nuclear Astrophysics

From the first few seconds of the Big Bang that created the seed material for our universe, through to the present energy generation in our Sun that keeps us alive, nuclear physics has shaped the evolution of the universe and our place in it. Along the way, nuclear reactions have controlled the evolution and death of stars forming the most compact objects in the Universe, determined the chemical evolution of galaxies and produced the elements from which we ourselves are built. Our understanding of this complex evolution has developed as a result of nuclear physicists working closely with cosmologists, astrophysicists and astronomers in a hugely productive collaborative effort to understand the development of the universe and our place in it.

Some of the crucial questions to be answered are:

- How and where are the elements made?
- Can we recreate on Earth, and understand, the critical reactions that drive the energy generation and the associated synthesis of new elements in the stars.
- What are the properties of dense matter in a hypercompact object such as a neutron star or a quark star?
- How does the fate of a star depend on the nuclear reactions that control its evolution?

Over the last decade our understanding has progressed tremendously due not least to significant experimental advances connected to the use of the Gran Sasso deep underground accelerator and a variety of surface laboratories to study a wide variety of reactions of astrophysical relevance whose reaction probabilities (cross sections) are still poorly known. Many of these important reaction studies require the usage of unstable nuclei as projectiles in accelerator experiments.

Along with the nuclear structure community, the nuclear astrophysics community is eagerly awaiting the completion of the next generation of radioactive beam facilities (FAIR, SPIRAL 2, HIE-ISOLDE and SPES) which will provide a rich variety of complementary beams needed to answer key questions regarding the energy generation and element synthesis in explosive objects like Novae, X-Ray Bursters and Supernovae. These facilities are the precursors to EURISOL, which will be developed in the following decade. An immedi-

ate, pressing issue is to select and construct the next generation of underground accelerator facilities. Europe was a pioneer in this field, but risks a loss of leadership to new initiatives in the USA. Providing an underground multi-MV accelerator facility is a high priority. There are a number of proposals being developed in Europe and it is vital that construction of one or more facilities starts as soon as possible.

Recently there has been rapid advance in our understanding of Supernovae and a growing realisation of the role of the weak interaction. High-resolution data have been obtained for Gamow-Teller (GT) transitions, i.e. transitions involving the transformation between neutrons and protons with conserved parity, at KVI (Netherlands). These are crucial for constraining the theoretical calculations of electron capture rates on nuclei around iron and to validate theoretical calculations of weak interactions relevant for understanding supernovae explosions. Experimentally, it will be necessary to extend charge exchange experiments to unstable nuclei using radioactive ion-beams and inverse kinematics. Some of the mechanisms underlying the instabilities that appear during the collapse of supernovae cores will become accessible to experimental study at the NIF and PHELIX facilities in the USA and at GSI/FAIR, Germany.

A full understanding of supernovae explosions will require hydrodynamics simulations with accurate neutrino transport and high precision nuclear physics input. Better, a microscopic and self-consistent Equation of State (EoS), constrained by the experimental data, must be developed and implemented in future simulations.

To exploit the potential of future neutrino detection fully, it is essential to have reliable estimates of neutrino-nucleus cross sections. The construction of a dedicated detector for the measurement of neutrino-nucleus cross sections, for example at the future European Spallation Source (ESS), would be a very valuable tool.

The development of new radioactive ion beam facilities like FAIR at GSI (Germany) and SPIRAL2 at GANIL (France), will open up for experimental studies of very exotic nuclei with direct impact on the modelling of compact stars. The analysis of multifragmentation in heavy-ion collisions will elucidate the structure at the crust-core boundary. The new experimental facilities, such as PANDA at FAIR, will allow for the efficient production of hypernuclei, offering new perspectives for studying hyperonic matter and the largely unknown hyperon-hyperon interaction.

The properties of matter at very high densities are presently very uncertain. Future experiments like CBM at FAIR will provide decisive constraints and help us understand the confinement phase transition between quark matter and hadronic matter in massive stars.

# 1. Executive Summary

---

Advances in nuclear theory for astrophysics will be strongly coupled to the development of improved nuclear structure theory. A special phenomenon relevant in astrophysical environments is the influence of free electrons in the plasma on reactions and decays. Accurate treatments for intermediate or dynamic screening and the dependence on the plasma composition have still to be developed. Furthermore, all stellar models studying nucleosynthesis are currently 1-dimensional. Future improved models using a multi-dimensional approach will require vastly more accurate input from nuclear reaction data and high performance computing resources.

## 1.4.5 Fundamental Interactions

We know of four fundamental interactions, or forces, in nature that govern how matter is assembled from fundamental units into the more complex entities that our world consists of. They are gravitation, the weak interaction, electromagnetism, and the strong interaction.

The Standard Model (SM) provides a powerful theoretical framework in which the weak interaction and electromagnetism and many aspects of the strong interaction can be described to remarkable precision in a single coherent picture. The SM has three generations of fundamental fermions, which fall into two groups, leptons and quarks. Forces are mediated by bosons: the photon, the  $W^\pm$ - and  $Z^0$ -bosons, and eight gluons.

The SM is found to describe many observations very well. Nevertheless, it has significant shortcomings. For example, the SM cannot account for dark matter and dark energy in the Universe. These are central outstanding questions in our description of nature and the Universe.

Nuclear physics provides a powerful platform to study fundamental physics and interactions by means that are complementary to high-energy particle physics and in many cases unique.

Some of the key questions are:

- What is the origin of the matter dominance in the universe?
- What are the properties of neutrinos and of antimatter?
- Are there other than the four known fundamental forces?
- What are the precise values of the fundamental constants?
- Which fundamental symmetries are conserved in nature?

Accurate calculations within the SM provide a basis for searches of deviations from SM predictions. Such deviations can reveal new phenomena beyond the standard model that could point to a more general united theory of

all four fundamental forces, or even provide hints regarding the validity of speculative extensions to the SM. The existence of phenomena such as neutrino oscillations, dark matter and the matter-antimatter asymmetry are striking manifestations of physics beyond the SM.

To address the central issues and questions, research on fundamental interactions should focus on a number of topics in mainly three areas: fundamental symmetries, properties of neutrinos, and properties of the electroweak interaction.

In the area of fundamental symmetries, searches for permanent electric dipole moments of particles (e.g. the neutron-EDM experiments) or novel techniques such as the searches for EDMs of trapped atoms and for EDMs of ions in storage rings could be key to understanding the matter-antimatter asymmetry of the Universe. Parity violation measurements with atoms and ions of caesium, francium (LNL Legnaro) and radium (KVI Groningen) can lead to the discovery of physics beyond the SM. Precision experiments e.g. with antihydrogen at the Antiproton Decelerator of CERN will lead to improved limits on, or discoveries of, the violation of Lorentz or CPT invariance.

Neutrino properties, like their masses and the mass-hierarchy, will be addressed in new direct neutrino mass measurements (by KATRIN at Karlsruhe Institute of Technology and by the MARE collaboration). Experiments to search for the neutrinoless double beta decay investigate whether neutrinos are their own anti-particles, a question of paramount importance for understanding the underlying symmetries of particle interactions and the origin of neutrino masses. Neutrino oscillation experiments will investigate the details of the neutrino-mixing matrix. One of the solutions for producing the high-intensity neutrino beams needed for the study of the major open question of CP violation in the lepton sector, the beta beam concept, could be realised as a natural extension of the EURISOL project.

Precision measurements of electroweak interaction properties in beta decay are a sensitive means to search for non-standard model weak interactions, i.e. right-handed currents and scalar or tensor type charged current weak interactions. New experimental tools for experiments in neutron decay (such as e.g. PERC) and nuclear beta decay (e.g. atom and ion traps) as well as improved simulation tools will boost this field. Accurate predictions from the best and most reliable field theory we have, i.e. QED, are necessary for improved determination of fundamental constants, e.g. in experiments with light hydrogenic ions, antiprotonic helium, highly charged ions, many electron atoms, and “g-2” experiments.

The achievement of these goals requires support of small-sized laboratories and university groups that



---

can provide a stimulating environment for the training of young people. Support of theory groups that give guidance to the experimental physicists is necessary. A variety of dedicated facilities are needed: Intense sources of low-energy antiprotons (ELENA at CERN-AD and in the longer term, the modules 4 and 5 of the FAIR facility at Darmstadt) will boost research into the properties of antimatter. Experiments requiring low background, such as double beta decay experiments, require upgraded and potentially new underground laboratories. Further, this field will benefit from intense beams of cold and ultra-cold neutrons (at ILL Grenoble, PSI Villigen and FRM-II Munich) and exotic nuclei (available at HIE-ISOLDE, DESIR and EURISOL). Finally, many experiments in this field need regular access to beams or long continuous beam time periods, which should be provided by dedicated facilities like ISOL@MYRRHA.

#### 1.4.6 Nuclear Physics Tools and Applications

The development of Nuclear Physics, since the first discovery of the atomic nucleus by Rutherford in the early 20<sup>th</sup> century has been intimately tied to the development of new detection techniques, accelerators and to theoretical and simulation frameworks. A large number of these have found, and will increasingly find, applications in daily life, well outside the realm of nuclear physics and indeed of physics itself.

Nuclear physics finds increased applications within trans-disciplinary areas as diverse as Energy, Nuclear Waste Processing and Transmutation, Climate Change Containment, Life Sciences and Cancer Therapy, Environment and Space, Security and Monitoring, Materials Science, Cultural Heritage, Arts and Archaeology.

Key central questions and issues are:

- How can Nuclear Physics contribute to the sustainability and acceptability of the generation of nuclear energy?
- How can Nuclear Physics techniques improve medical diagnostics and contribute to cancer therapy?
- How can radiation hazards in Space be monitored and predicted?
- Can Nuclear Physics help understand and monitor climate change?
- Can neutrinos be used as a probe for non-proliferation control?
- Can Nuclear Physics help to visualize the dynamics of ion-beam processes when other methods fail?
- How can non-destructive and in-depth analysis of elements in materials samples be improved?

Ion beams of all elements (stable and radioactive), from keV to hundreds of GeV, and advanced detection techniques provide new opportunities in materials sci-

ence, nanotechnology, planetary and Earth sciences, and plasma physics. Recent sensitivity improvements of Atomic Mass Spectroscopy (AMS) techniques funnel progress in nearly all application domains, especially for cultural heritage studies, radiopharmaceutical research and environmental and security applications.

Research on plasma-based (wakefield) accelerators could lead to the development of much more compact and cheaper machines allowing for a larger dissemination of nuclear analysis techniques and for cheap and compact hadron therapy tools and must be actively pursued.

The field of high-intensity accelerators benefits strongly from synergies between radioactive beam production, studies of Accelerator Driven subcritical reactor Systems, ADS, the International Fusion Materials Irradiation Facility, IFMIF, radiopharmaceutical isotope production, and the European Spallation Source, ESS, project.

At present, numerous applications need more accurate nuclear data (production cross-sections, characteristics of produced particles, nuclear structure data, data for fission or fragmentation of light-ions, etc... and reaction models) to extend European data libraries and to develop more accurate transport and simulation computer codes. This is of particular relevance for nuclear energy (fission and fusion), particle therapy, radioprotection, security and space applications. A substantial effort should be put on the evaluation process so that measurements can be analysed rapidly and results inserted quickly into European data libraries.

The measurement of nuclear data and research in materials science requires special nuclear targets or samples of high isotopic purity, sometimes radioactive. Issues regarding target and sample fabrication, characterisation, and, in the case of radioactive isotopes, manipulation and transportation, should be given sufficient attention. Coordination/networking of target production facilities, including radiochemistry laboratories, should be foreseen and standardised transportation procedures established.

Many small-scale facilities and specialised installations at large scale facilities are unique due to the particular equipment or application they provide. In order for Europe to secure a leadership role in nuclear applications, the support for these activities should be strengthened at research infrastructures by making sufficient beam time available.

To keep Europe at the cutting edge it is strongly recommended to closely interlink the existing complementary equipment and areas of specialisation provided by many facilities (for instance through networks of IBA,

# 1. Executive Summary

---

and AMS or high-energy irradiation facilities). Networking between fundamental physicists and end-users (reactor physicists, medical physicists, engineers, etc.) should be strengthened. Communication with medical doctors, climate scientists, environmental scientists, archaeologists, curators, and other potential beneficiaries of the nuclear techniques should be improved through non-technical publications, outreach activities, and joint meetings.

One of the central contributions of Nuclear Physics to society is the human capital trained in advanced techniques that is transferred to industry (in particular nuclear industry), medical centres, applied research organisations or governmental bodies linked to the different aspects of nuclear applications (as radioprotection and safety authorities). It is imperative to maintain this knowledge base to ensure that these organisations continue to have access to the necessary expertise.

## 2. Recommendations and Roadmap

---

### 2.1 Recommendations

We wish to issue the following recommendations of how best to develop the field of Nuclear Physics in Europe in the next decade and beyond.

#### ESFRI Facilities

Complete in a timely fashion the construction of the Nuclear Physics facilities on the ESFRI list of large-scale research infrastructure projects in Europe:

- **FAIR** at the GSI site in Darmstadt, including its four pillars, the PANDA experiment using antiprotons to study the structure and spectroscopy of strongly interacting particles (hadrons), the NuSTAR radioactive beam facility to produce nuclei far from stability and investigate their structure, the CBM experiment to measure the properties of dense baryonic matter, and the atomic, plasma, and applied physics programme APPA.
- **SPIRAL2** at GANIL in Caen, including high intensity stable beams which will allow the study of unstable nuclei at the S3 spectrometer, and ISOL radioactive beams of very neutron-rich fission products and studied, for example, at the DESIR facility.

#### Major Upgrades

Perform major upgrades of the following large-scale Nuclear Physics facilities, which complement each other regarding their physics scope and discovery potential:

- **HIE-ISOLDE** at CERN, including its radioactive beam experiments.
- **SPES** at INFN-LNL in Legnaro, including its radioactive beam experimental set-ups.
- **AGATA**, the  $\gamma$ -ray spectrometer consisting of semiconductor detectors that will be used at the facilities SPES, HIE-ISOLDE, SPIRAL2 and FAIR.
- The new **Superconducting Linac** for the provision of high-intensity stable beams at GSI to search e.g. for superheavy elements.

#### ALICE

- Upgrade the **nuclear beams** at the LHC and the **ALICE detector** to expand the physics reach for studying quark-gluon matter at CERN.

#### Theory

Strengthen theory support to experiment by developing the collaboration between national theory groups through new transnational programmes.

- Strengthen the financial basis of the theoretical research infrastructure **ECT\*** in Trento to increase

its involvement in European theory initiatives.

- Strongly support **advanced studies** related to the experimental roadmap and the improvement of the link between nuclear theory and Quantum Chromodynamics.
- Invest in **high-performance computing** facilities dedicated to Nuclear Physics projects.

#### Existing Facilities

Fully exploit the currently existing large-scale research infrastructures (listed below in north to south order) and perform limited-size upgrades to ensure the best use of the large investments made in the past:

- The **lepton beam** facilities (electron/positron, muon beams) ELSA in Bonn, MAMI in Mainz, COMPASS at CERN, DAΦNE at INFN-LNF Frascati, and the **hadron beam** facilities COSY at FZ Jülich and at GSI to perform detailed studies of the structure of hadrons such as protons and neutrons.
- The **heavy ion beam** facilities JYFL Jyväskylä, KVI Groningen, GSI Darmstadt, GANIL Caen, IPN Orsay, ISOLDE at CERN, INFN-LNL Legnaro and INFN-LNS Catania to study the structure of nuclei and fundamental interactions.
- The nuclear astrophysics underground accelerator **LUNA** at INFN Gran Sasso, and the exploration of advanced new facilities.
- The **ELENA** upgrade of the Antiproton Decelerator at CERN to study antimatter.

Fully exploit smaller scale **national and university Nuclear Physics laboratories** across Europe dedicated to nuclear structure and astrophysics experiments, fundamental interactions and nuclear applications.

#### Applications and Education

Secure and further develop the Nuclear Physics skills base in view of current and future needs, in particular regarding:

- Novel developments in **energy generation** (nuclear fission and nuclear fusion), **medicine** (e.g. imaging and tumour therapy) and **security**.
- Development of novel **sources**, (micro) **beams**, (high power) **targets** and **radiation detection** instrumentation that will also be used in other fields of science and engineering, and in the life sciences.

#### Future Facilities

Continue the scientific and technical assessments for building new large-scale Nuclear Physics facilities in the future, and specifically promote:

- The inclusion of the high-intensity ISOL facility

## 2. Recommendations and Roadmap

**EURISOL** in future updates of the ESFRI list, based on the successful EURISOL Design Study in FP6.

- The Technical Design Study for intense radioactive ion beams at **ISOL@MYRRHA**.
- The Technical Design Study for a polarised proton-antiproton, **PAX**, and an electron-nucleon/ion collider, **ENC**, at FAIR.
- The Technical Design Study for a high-energy electron-proton/ion collider, **LHeC**, at CERN.
- The inclusion of Nuclear Physics programmes at the multi-purpose facilities **ELI** and **ESS**.

### 2.2 Facilities Roadmap

We present below the roadmap for building new large-scale Nuclear Physics research infrastructures in Europe. The time span ranges until the middle of the next decade. Facilities whose first phases have already been approved are coloured in blue, future upgrades thereof in dark blue. The ISOL facilities SPIRAL 2, HIE-ISOLDE and SPES are designated to lead to EURISOL. PAX and the ENC at FAIR, EURISOL and the LHeC at CERN are still in the design or R&D phase. They are coloured in purple.

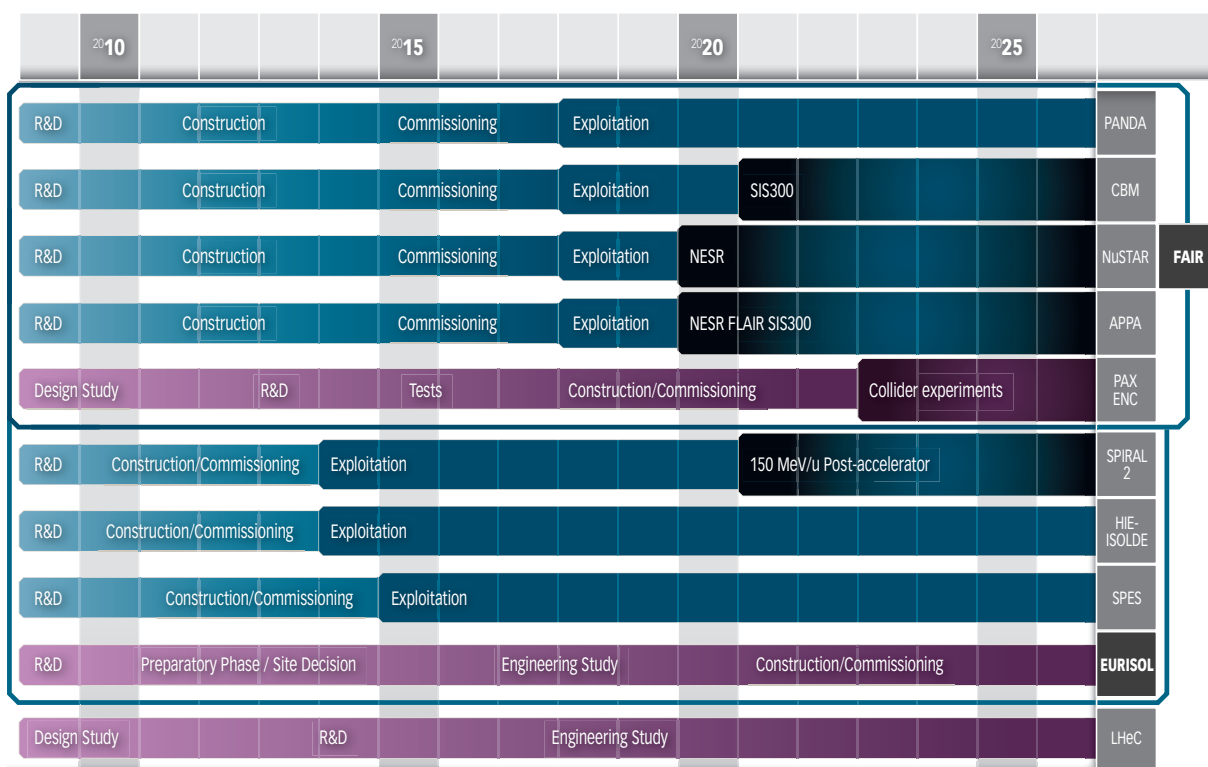

Roadmap for New Large Scale Facilities.



## 3. Research Infrastructures and Networking

In this chapter, we present the European landscape of current Nuclear Physics facilities, plans for building new large-scale research infrastructures (RIs) or performing major upgrades of existing ones, and the collaboration in the field at European and global level.

### 3.1 Existing Research Infrastructures and Upgrades

The current Nuclear Physics research infrastructures in Europe may be grouped into theoretical and computing, lepton and hadron beam facilities. They form a network of closely collaborating laboratories that enjoy the strong support of the European Union via their Framework Programme (FP) 7. Access to these research infrastructures is generally open to researchers whose proposals have passed the scrutiny of programme advisory committees. In presenting the research infrastructures below, we follow a north to south principle of arrangement.

#### 3.1.1 Theory and Computing

Both ECT\* in Trento and the Jülich Supercomputer Centre have been Research Infrastructures in the previous FP6's Integrating Infrastructure Initiatives (I3) EURONS and HadronPhysics. ECT\* continues to be supported in FP7's Integrating Activity HadronPhysics2.

##### ECT\*, Trento, Italy

The European Centre for Theoretical Studies in Nuclear Physics and Related Areas (ECT\*) is an institutional member of NuPECC and operates in the context of European Universities and Research Laboratories. With nearly 700 visitors from about 40 countries spending from one week up to several months at the Centre, ECT\* has achieved high visibility and fulfills an important coordinat-



ECT\* at Trento in Italy.

ing function in the European and international scientific community by:

- Performing in-depth research on topical problems at the forefront of contemporary developments in Nuclear Physics (Nuclear Structure and Nuclear Reactions of Nuclei far off the Line of Stability, Hadrons and QCD, Matter under Extreme Conditions), and related fields (Particle Physics, Nuclear and Particle Astrophysics, Condensed-Matter Physics, Ultracold Gases, BEC and Quantum Physics of Small Systems).
- Holding up to 20 Workshops and Collaboration Meetings per year on the topical problems listed and strengthening thereby the interchange between theoretical and experimental physicists, an absolute prerequisite for the advancement in the various areas of research.
- Encouraging and supporting talented young physicists to attend yearly held Doctoral Training Programmes and arranging for them to participate in ECT\* research projects.
- Fostering intensive interdisciplinary contacts between Nuclear Physics and neighbouring fields.

Furthermore, presently and in the years ahead, ECT\* administers scientifically the AuroraScience project which consists of interdisciplinary proposals that explore the architectural opportunities for high performance computing (HPC) systems optimised for a number of highly relevant scientific computing applications in Physics, Biology, Bioinformatics and Medical Physics. It is a joint PAT/INFN project involving several local and national institutions and is embedded into the European scene of HPC.

In summary, ECT\* plays an important role in Nuclear Physics and is highly appreciated by the large and growing community of its users. Its scientific projects are overseen by an internationally composed Scientific Board. ECT\* is the only centre of its kind in Europe and faces new opportunities and challenges in the gradual emergence of a European Research Area and more and more international coordination.

##### Jülich Supercomputer Centre, Germany

The Jülich Supercomputing Infrastructure is the core of the Jülich Supercomputing Centre (JSC), a European leadership HPC centre at Forschungszentrum Jülich. JSC's strategy is a dual architecture to have always a competitive leadership-class, highly scalable machine, and a general-purpose system with a balance of approximately five to three, in terms of capability. Today, the leadership-class machine is an IBM Blue Gene/P system with 1 Petaflops peak performance, called JUGENE, while the general-purpose system is realised by an Intel-Nehalem based cluster called JUROPA with more than

## 3. Research Infrastructures and Networking

300 Teraflops peak performance. JUGENE is currently the fastest supercomputer in Europe, while JUROPA is ranked no. 3 in Europe.

Besides the provision of high-end supercomputers, JSC is concentrating on technology development together with hardware and software vendors, R&D work in computer and computational sciences and high-level user and application support. The infrastructure exists since the 1980s and has evolved since then with always the latest supercomputer technology to one of the leading supercomputing infrastructures in Europe. Basic funding is provided by the Helmholtz association, which is supplemented to a large extent by the German Federal Ministry of Education and Research (BMBF) and the Ministry for Innovation of North Rhine-Westphalia. European funding is also provided for R&D projects and is being announced in the framework of the emerging European HPC infrastructure PRACE (Partnership for Advanced Computing in Europe).

The supercomputers are available to German and European researchers who have successfully passed a well-established scientific peer-review procedure. The infrastructure is able in particular to accomplish projects, which have system demands far beyond the capacities universities or regional centres can offer. The systems in Jülich are mainly used by researchers focusing on basic natural sciences. Today, a major share of about 40% is granted to hadron and elementary particle physics – mainly lattice quantum chromodynamics (QCD) and *ab-initio* nuclear structure calculations in the effective field theory (EFT) framework. The supercomputing infrastructure at Jülich has already been used successfully by the EU HadronPhysics I3 from 2004-2008.



The IBM Blue Gene/P system JUGENE with 1Pflops peak performance at the Forschungs-zentrum Jülich.

### 3.1.2 Lepton Beam Facilities

These research infrastructures provide beams of electrons, positrons or muons, or beams of real photons to perform experiments in, primarily, hadron physics.

#### MAX-lab, Lund, Sweden

MAX-lab is a Swedish national facility operated jointly by the Swedish Research Council (VR) and Lund University. The research areas cover accelerator physics, research based on the use of synchrotron radiation and nuclear physics using electromagnetic probes.

The injector consists of two linear accelerators equipped with SLED cavities. The linacs are operated at 10 Hz and the approximately 200 ns wide pulses are stretched in the MAX I ring. The electron beam is extracted over a period of 100 ms and brought to the experimental area. The duty cycle is typically 40-50 per cent. So far electron energies between 140 MeV and 200 MeV have been used in experiments with tagged photons created in thin radiators placed in front of one of two magnets, the End Point Tagger (ET) or the Main Tagger (MT). At present, it is possible to obtain tagged photons in the range of 10 to 185 MeV. The energy resolution is typically 500 keV, determined mainly by the width of the plastic scintillators in the focal plane hodoscope. This hodoscope as well as the two magnetic spectrometers were constructed and built at the Saskatchewan Accelerator Laboratory. At present a new hodoscope is being assembled which will allow better energy resolution and larger energy span. The operating current is about 20-40 nA and the rate of tagged photons is about 0.8 MHz MeV<sup>-1</sup>.

The research programme in nuclear and hadron physics utilizes 18 weeks of beam time annually. The instrumentation for this research programme consists of various detector systems. For studies of Compton scattering and the  $(\gamma, \pi^-)$  reaction from deuterium we have access to three large single crystal NaI(Tl) spectrometers, each with a diameter of about 50 cm and a length of 50 cm. Additional smaller NaI(Tl) detectors (10" x 10") are also available. For the detection of charged particles several detector systems are available; SSD-HPGe, SSD-CsI(Tl), and  $\Delta E-E$  plastic scintillator telescopes, as well as range telescopes. These are presently being used for studies of the  $(\gamma, \pi^+)$  reaction. Five of the Ge6 stacked telescopes are among the available detectors at MAX-lab. We have access to 10 plastic scintillator time-of-flight detectors (10 x 20 x 300 cm<sup>3</sup>) and 16 small liquid-scintillator neutron detectors ( $A_{\text{total}} \approx 0,35 \text{ m}^2$ ). Additional liquid-scintillators are being assembled based on a new, simple design that allows various detector configurations. Recently, an active, scintillating He target,



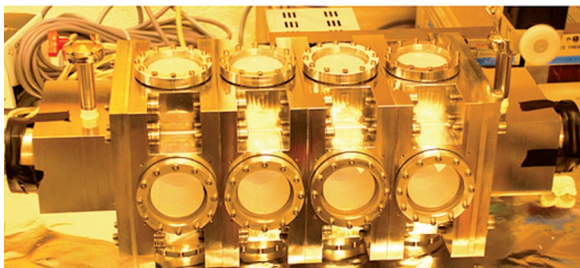
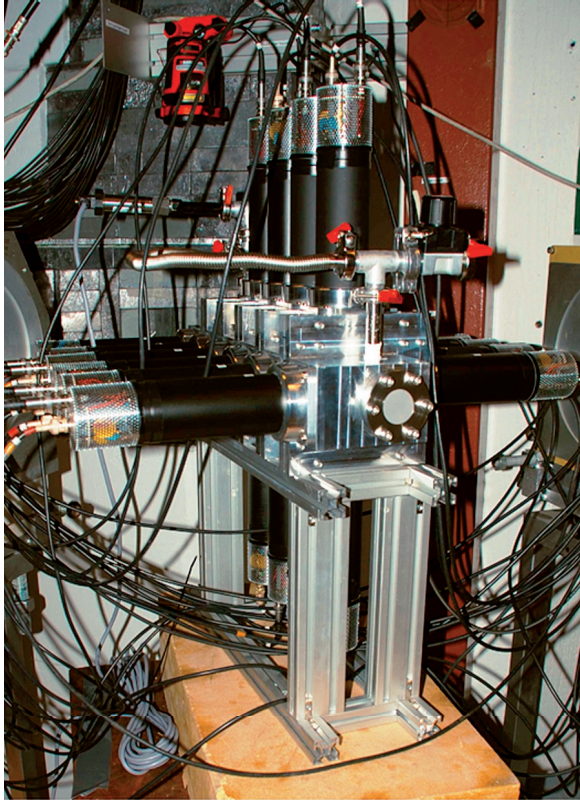

Glasgow active He-Target at MAX-lab, filled with scintillating He gas at 20 bar pressure.

consisting of 4 individual cells each equipped with 4 PMTs, has been placed at MAX-lab and used in combination with the liquid-scintillator neutron detectors. We have access to a liquid  $^4\text{He}$  target and a liquid deuterium target. The data acquisition equipment includes 4 identical VME systems in two separate counting rooms. The detector systems listed above are partly brought to MAX-lab by the large international collaboration working at the laboratory.

## ELSA, Bonn, Germany

The Electron Stretcher Accelerator (ELSA) is a facility run by the University of Bonn/Physikalisches Institut and thus under the auspices of the German federal state Nordrhein-Westfalen. It consists of 2 electron LINACs, a booster synchrotron and an electron stretcher ring. Unpolarised or polarised electron beams are injected into the synchrotron by LINACs I or II, resp., at energies around 20 MeV. They are then accelerated to 1.2 GeV typically and transferred into the stretcher ring. This can be operated in booster, stretcher and storage mode. In the booster mode, normally used for hadron physics experiments, several pulses from the synchrotron are accumulated in the stretcher ring (internal current 20 mA, typ.). The electrons are further accelerated to max. 3.5 GeV, slowly spilled via resonance extraction and delivered to experiments (typical spill time 4 – 6 sec). At LINAC I, a test area for materials irradiation and detector tests is presently being refurbished. Furthermore, a new beamline connected to the stretcher ring is under construction. It will provide electron beams to an area for detector tests and characterisation up to the full energy with currents of 1 fA – 100 pA and a duty-factor of approx. 80 %.

The research activities at the ELSA facility focus on hadron physics, in particular on baryon spectroscopy via meson photo-production in double polarisation configurations. Two experimental areas exist, each equipped with a photon tagging system and diamond radiators to provide linearly polarised photon beams:

- **CB-ELSA/TAPS**

The Crystal Barrel Spectrometer, augmented by elements of the TAPS detector, is ideal for photonic final states. It can house a solid-state polarised hydrogen/deuterium target and has delivered a plethora of data on single and double meson production, without and with beam and target polarisations.

- **BGO-OD**

The BGO-OD spectrometer is presently under construction and has undergone first tests. It is based on the BGO ball, previously used in the GRAAL experiment at Grenoble, and a large forward open dipole along with tracking devices. It will allow simultaneous detection of emerging photons and forward going fast hadrons, thus being complementary to the CB-system.

Beam time at ELSA is allocated on the basis of proposals submitted to the laboratory upon recommendation by a Programme Advisory Committee, with review meetings commonly held with MAMI/Univ. of Mainz.

ELSA served as the germ of a Transregional Collaborative Research Center, SFB/TR 16, of the German Funding Agency (Deutsche Forschungsgemeinschaft) constituted by groups of the universities of Bonn (home

### 3. Research Infrastructures and Networking

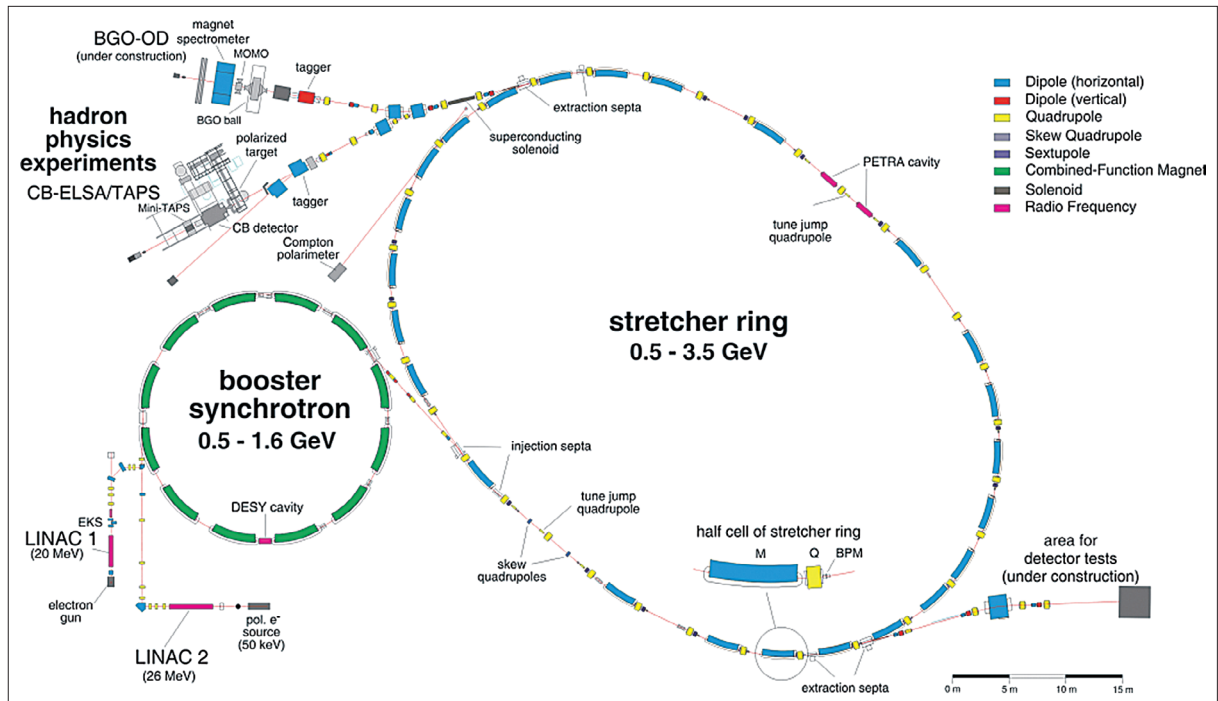

ELSA nuclear physics research infrastructure at the University of Bonn in Germany.

university), Bochum and Giessen. The mentioned list of activities will be continued at least until the foreseen duration of the SFB/TR 16 (mid 2016). Furthermore, ELSA collaborates with the Helmholtz Alliance HA-101 “Physics at the Terascale” and provides beam for detector tests.

To match increased demands of forthcoming experiments, the ELSA accelerator is being prepared to deliver higher external beams than now (typ. 10-times), along with other improvements. The complex structure allows for studies of questions in accelerator physics relevant for future plans, e.g. a new Electron Nucleon Collider (ENC).

#### MAMI, Mainz, Germany

The Mainz Microtron (MAMI) facility at the Mainz University is a unique facility for high-precision electron scattering as well as photo production experiments. In 2008, the beam energy was increased from 885 MeV (MAMI-B) to 1508 MeV (MAMI-C) and in 2009 subsequently to 1558 and 1604 MeV maintaining the excellent beam quality of MAMI. The energy upgrade to MAMI-C was achieved by adding a fourth stage of a racetrack microtron to MAMI, which represents a novel design in microtron accelerator technology and consists of a so-called Harmonic Double Sided Microtron (HDSM)

with one of two LINACs operating at the first harmonic frequency (4.90 GHz).

The increase of the MAMI beam energy did not only allow to pass the threshold to strangeness production in electron scattering experiments, but makes MAMI also a unique meson factory with world-class photoproduction rates for  $\eta$ ,  $\eta'$ , and  $\omega$ -mesons. It should be noted that it is not only the high statistics, which makes research in this field very attractive at MAMI, but also the very low background conditions, which are superior to e.g. hadron machines. The hadronic structure investigations at MAMI using the electromagnetic probe at low momentum transfers complement measurements of other major hadron physics facilities worldwide. This complementarity shows itself along two lines: complementarity due to the different probes, and complementarity in the kinematical/energy range.

The combination of high intensity beams, polarisation of both, beam and target, and the multi-spectrometer setup for high resolution electron scattering experiments (A1 Collaboration) as well as the large acceptance Crystal Ball detector available for real photon experiments (A2 Collaboration) makes it possible to enter a new era of precision measurements.

In the upcoming years the research at MAMI will focus on high precision measurements of several key observa-



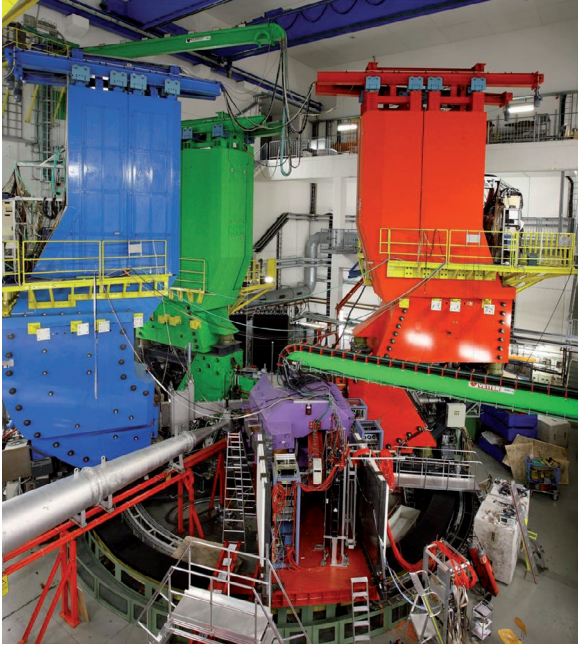

Upstream view of the high-resolution spectrometer facility at MAMI, consisting of four spectrometers operated in coincidence to observe electrons (blue spectrometer), protons (red), pions (green) and kaons (violet spectrometer in the centre).

bles made possible by novel instrumentation presently under construction or in the planning phase:

- Form Factors of baryons are one of the most fundamental observables of hadron physics since they are related to the distribution of charge and magnetization of those objects. At MAMI the construction of a highly efficient neutron detector is planned for a series of novel precision measurements of the electric and magnetic form factors of the neutron.
- Polarisabilities of the proton, neutron and pion can be approached by the A1 as well as the A2 Collaborations. At a later stage, also Compton scattering experiments of light nuclei are foreseen. The newly installed polarised frozen-spin target at the tagged photon facility A2 will allow significant progress for real Compton scattering experiments, and the higher beam energy of MAMI-C will allow for an extension of existing measurements towards higher  $Q^2$  values in electron scattering (virtual Compton scattering).
- Baryon Resonances: To obtain a deeper understanding of the dynamical origin of baryon resonances beyond the naive quark model, a set of well-selected states in reach at MAMI-C beam energies, like the Roper resonance, will be investigated. This implies on the experimental side precision measurements of transition form factors in electroproduction (A1 collaboration), measurements of radiative decays and

the full exploitation of polarisation degrees of freedom using the polarised target (A2 collaboration), which just came into operation.

- Strangeness and Hypernuclei: Precision measurements of the kaon-nucleon interaction and of light hypernuclei are of utmost importance to validate the various theoretical approaches presently trying to bridge this gap between nuclear and hadron physics. At MAMI the newly installed forward double-spectrometer KAOS is of central importance for these investigations.
- Parity violation in low energy ep scattering may in the future be explored at the recently proposed Mainz Energy recovering Superconducting Accelerator (MESA). Based on the long-standing expertise in the design of electron accelerators at the University of Mainz, the construction of a compact CW linear accelerator for innovative electron scattering experiments using beam energies at or below pion threshold is envisaged. The MESA project will combine two recent breakthroughs in accelerator technology, namely (i) the successful realization of high gradient CW superconducting cavities and (ii) the design of energy recovering linear accelerators. Beam currents up to 10 mA are expected at energies up to 137 MeV and at high degrees of polarisation.
- *Ab initio* Lattice QCD calculations of masses, magnetic moments and electromagnetic couplings of the low-mass baryon resonances can be performed thanks to the availability of a dedicated High Performance Computing (HPC) cluster at Mainz Univ. and complement the theoretical investigations using unitary isobar models or effective field theoretical techniques.

### COMPASS at CERN, Geneva, Switzerland

COMPASS is a high-energy physics experiment at the Super Proton Synchrotron (SPS) at CERN. The Collaboration consists of nearly 240 collaborators from 11 countries and 28 institutes. The purpose of the experiment is the study of hadron structure and hadron spectroscopy with high intensity muon and hadron beams.

The spectrometer was installed in 1999-2000 and was commissioned during a technical run in 2001. Data taking started in summer 2002 and continued until fall 2004. After a one-year shutdown in 2005, COMPASS resumed data taking with a muon beam in 2006 and 2007. The years 2008 and 2009 were dedicated to the COMPASS hadron spectroscopy programme with pion and proton beams. In 2010, structure function measurements with a polarised proton target will continue.

In spring 2010, a proposal for an upgrade to the experiment (COMPASS II) has been submitted. COMPASS II

### 3. Research Infrastructures and Networking

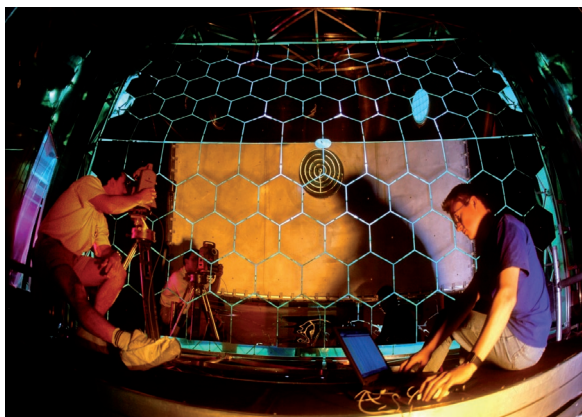

COMPASS at CERN: Physicists calibrating the mirrors of the RICH detector.

is envisaged to run for another 5 years. The physics programme will cover in particular:

- Tests of chiral perturbation theory.
- Measurements of generalised parton distributions.
- Measurements of Drell-Yan production.

#### INFN-LNF, Frascati, Italy

The Frascati National Laboratories (LNF) founded in 1955, are the oldest and largest laboratory of the National Institute of Nuclear Physics (INFN) in Italy. They were built to host the Electron Synchrotron (1.1 GeV), a world-leading accelerator at that time. The first prototype of an electron-positron storage ring ADA was then built, and after that, the large electron-positron collider ADONE (3 GeV in the centre of mass) led to the discovery of the colour structure of the quarks. At ADONE, the very active community pushed innovative techniques still in use worldwide: monochromatic beams of bremsstrahlung photons and the first Compton backscattered beam.

The current  $e^+e^-$  meson factory DAΦNE, at 1020 MeV c.m. energy, has been operated for more than 10 years. A broad physics programme ranging from the study of CP and T violation in kaon decays to that of hypernuclei and kaonic atoms has been pursued. The collider has

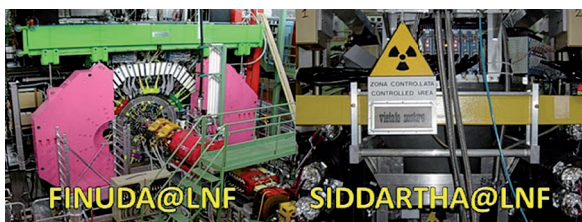

The hypernucleus experiment FINUDA (left) and exotic atoms experiment SIDDARTHA (right) at DAΦNE.

reached luminosities of  $5 \times 10^{32} \text{ cm}^{-2} \text{ s}^{-1}$ , two orders of magnitude larger than those of previous generation colliders. One of the key-points for the luminosity increase was the use of the Crab Waist (CW) collision scheme. Because of this result, a new project of a Super-B factory with luminosity as high as  $10^{36} \text{ cm}^{-2} \text{ s}^{-1}$  is being developed.

More than 10 years of activity at DAΦNE, performed at the KLOE, DEAR, FINUDA and SIDDHARTHA experiments, led to unprecedented results in some of the main fields of nuclear research. The unique production of a clean  $K^-$  source from DAΦNE allowed detailed investigations of hyper-nuclei with simultaneous measurements of their formation and decay properties to investigate the kaon-nucleon interaction and to obtain the isospin dependent antikaon-nucleus scattering lengths, very precise measurements of the shift and width of 1s-level of kaonic atoms were made through the detection of X-rays transitions. The study of the problems related to the low energy  $K^-$ -nucleus interaction made by FINUDA has indicated the possible existence of Deeply Bound kaonic States. These latter new interesting topics are planned to be extensively investigated in the next years at DAΦNE, and they represent one of the main future activities of the laboratory.

A major upgrade of the DAΦNE accelerator aiming at delivering in a few years more than  $50 \text{ fb}^{-1}$  at the  $\Phi$  resonance and successively about  $5 \text{ fb}^{-1}$  at a centre of mass energy in the energy range 1GeV – 2.5 GeV, is presently under investigation with a compelling scientific case including the measurement of the nucleon form factor in the time-like region.

At the same time, LNF pursues goals in different fields of research: elementary and astroparticle physics, gravitational waves, theoretical physics, multidisciplinary activities using synchrotron radiation beams, and detector and accelerator developments with the Beam Test Facility of the DAΦNE LINAC.

Among the new projects, SPARC, the high brightness electron beam driving the Self Amplified Spontaneous Emission-Free Electron Laser (SASE-FEL) in the green light, is now operating. The SPARC injector, in conjunction with a very powerful infrared LASER (light pulse of 300 TW and 25 fs), will allow investigations into the physics of plasma wave-based acceleration and the production of X-rays via Compton back-scattering. SPARC is also a test facility for the future X-ray based project SPARX.

### 3.1.3 Hadron Beam Facilities

Hadrons are strongly interacting particles. Most hadron beams consist of stable protons or light to heavy atomic ions. Beams of unstable neutrons or mesons (pions) are much harder to produce. Consequently, most of the accelerator facilities presented below (in strictly north to south order) use proton or heavy ion particle beams.

#### JYFL, Jyväskylä, Finland

The main accelerator facility of the Accelerator Laboratory of the University of Jyväskylä (JYFL) consists of a K=130 MeV cyclotron with two ECR ion sources and a multi-cusp ion source. The facility delivers a competitive range of stable-ion beams (from p to Xe) suitable for modern nuclear physics research and applications, with total beam time of around 6500 hours a year.

JYFL has been an access laboratory in EU-FP4-FP7 infrastructure projects and is an Academy of Finland Research Centre of Excellence. Annually it has approximately 250 foreign users and significant foreign investment in instrumentation. As a university laboratory, it provides a unique training site for graduate students and young researchers.

One third of the beam time is dedicated to tagging studies of exotic nuclei at the proton drip line and of

super-heavy elements. The RITU gas-filled recoil separator with detector arrays at the target area (JUROGAM Ge detector array) and the focal plane (GREAT spectrometer) is the most efficient system in the world for such studies.

A similar amount of beam time is used for comprehensive studies of nuclear ground state properties and exotic decay modes at the IGISOL ion-guide facility. Various species of cooled and bunched radioactive ion beams are delivered to beam lines equipped with ion traps for accurate nuclear mass measurements, detector systems for decay spectroscopy and laser systems for hyperfine structure studies.

The most important facility using beams from the 130 MeV cyclotron for applications is the RADIATION EFFECTS FACILITY (RADEF), which has been one of the official test sites of ESA since 2005. A 1.7 MV Pelletron accelerator is also used for applications.

Future perspectives:

- The new MCC30 (K=30 MeV) light-ion cyclotron and the extension of the laboratory provide improved research conditions and additional beam time for all research teams and users. More time can be released for beam development and for the use of heavy-ion beams from the K=130 accelerator in longer experiments and tests.

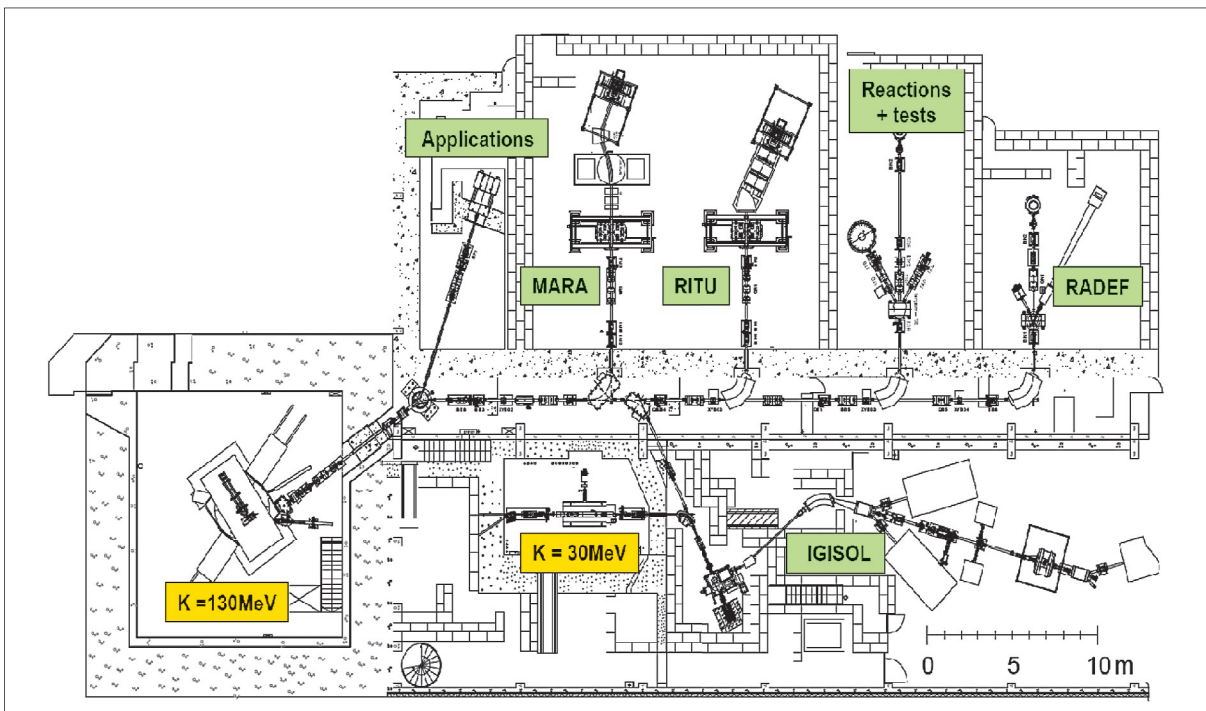

Plan for the upgrade of the JYFL Accelerator Laboratory.



### 3. Research Infrastructures and Networking

- Moving the IGISOL facility to the new experimental hall (served by both cyclotrons) will extend the discovery potential to unexplored exotic nuclei, which are important in explosive nucleosynthesis scenarios. In addition, the planned charge breeding of trapped ions will lead to unprecedented accuracy in mass measurements for weak interaction tests in atomic nuclei. A new laser-ion-source has been designed for IGISOL to generate new low-energy radioactive species.
- The new SAGE electron- and LISA charged-particle spectrometers are novel systems to be combined with JUROGAM and RITU for heavy element and rare particle-decay studies, respectively. The advanced MARA mass separator will open up new possibilities in probing light proton drip-line nuclei.

#### **KVI, Groningen, The Netherlands**

The Kernfysisch Versneller Instituut (KVI) at the University of Groningen is the only scientific accelerator laboratory in the Netherlands. The central facility is presently the superconducting cyclotron AGOR (K=600), which delivers protons of up to 190 MeV energy and heavy ions up to 90 MeV/nucleon ranging from deuterons to Pb. The cyclotron can deliver heavy ion beams of several 100 W. KVI further has a low energy ion beam facility for atomic, condensed matter and bio-physical research, which can deliver heavy ion beams up to 20 keV per charge state. The KVI facilities are open to an international user community.

Within the physics programme at AGOR, the TR $\mu$ P (Trapped Radioactive Isotopes – micro-laboratories for fundamental Physics) facility has a central role. Radioactive isotopes are produced in inverse kinematics reactions with heavy ion beams from the AGOR cyclotron. A magnetic separator splits off the primary beam and unwanted reaction by-products. The isotope beam is stopped in a thermal ionizer from where a low energy ion beam is extracted. It is cooled in a gas filled radio-frequency quadrupole (RFQ) device. Two beam ports exist for ion trapping in Paul traps and for neutral atom trapping in magneto-optic laser light traps. The TR $\mu$ P setup has been completed in 2009 and it is exploited by local scientists and international collaborations to search for New Physics beyond the Standard Model. The local scientific focus is on precision measurements of fundamental symmetries and interactions in experiments such as searches for permanent Electric Dipole Moments (EDMs), precision measurements of Atomic Parity Violation (APV) and accurate measurements of correlations in nuclear  $\mu$ -decays. High energy (MeV/nucleon) mass selected radioactive isotope beams are made available directly after the separator to the user

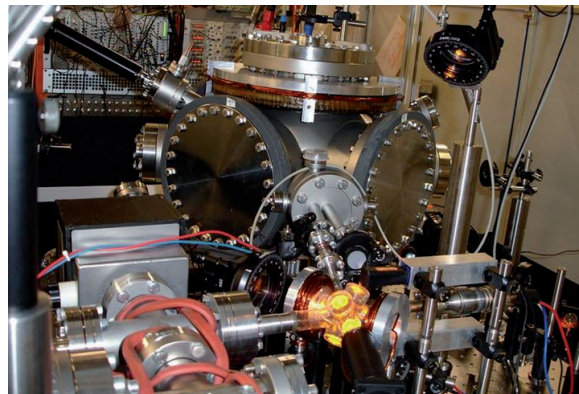

Setup for the TR $\mu$ P  $\mu$ -decay correlation measurements.

community for one beam cycle per year. The AGOR beams can also be used in combination with the Big Bite Spectrometer (BBS) for nuclear structure research.

The AGOR cyclotron further has a widely used calibrated irradiation facility where scientific and commercial users employ proton and heavy ion beams to investigate effects in material science and radiobiology. KVI has a vital cancer research programme together with the local university hospital (UMCG) and the Paul Scherrer Institute (PSI). This includes irradiation of cell cultures as well as of animals.

At KVI, astroparticle physics is conducted where radio-detection of cosmic rays is developed in the national and international context to complete the international Pierre Auger Laboratory in Argentina.

The future plans of KVI include the upgrade of the AGOR TR $\mu$ P facility towards beams of kW power and the setup of a GeV compact linear electron accelerator which can be combined with an undulator system to a Free Electron Laser providing soft x-rays in the 0.5 nm region for fundamental physics, materials science and biological research in the water window.

#### **COSY at FZ Jülich, Germany**

The COSY facility at the Institut für Kernphysik (IKP) of the Forschungszentrum Jülich (FZJ) is a worldwide unique facility for the investigation of hadron physics with hadronic probes. It comprises (i) sources for unpolarised and polarised protons and deuterons, (2i) the injector cyclotron JULIC, (3i) the cooler synchrotron to accelerate, store and cool the proton and deuteron beams, and (4i) internal and external detector systems, which use them for experiments.

H- (D-)ions are pre-accelerated up to 0.3 (0.55) GeV/c in JULIC, injected into COSY via stripping injection, and



subsequently accelerated up to a maximum momentum of 3.7 GeV/c.

Well-established methods are used to preserve polarisation during acceleration. A fast tune jumping system, consisting of one pulsed air core quadrupole, has been developed to overcome intrinsic depolarising resonances. Polarisation across imperfection resonances is preserved by the excitation of the vertical orbit using correcting dipoles to induce total spin flips. The polarisation can be continuously monitored by the internal EDDA detector. The polarisation achieved is  $> 75\%$  for protons up to the highest momentum. Vector and tensor polarised deuterons are also routinely accelerated with polarisations up to 60%.

Phase space cooling with electrons in the lower momentum range and stochastic cooling at higher momenta result in high brilliance beams that are supplied to the following internal or external experiments:

- ANKE is a large acceptance forward magnetic spectrometer placed at an internal target station in the COSY ring. The central dipole is movable to adjust the momentum range for the detected particles, independent of the beam momentum. Using deuterium cluster targets, reactions on the neutron are tagged by detecting the low energy recoil proton in silicon

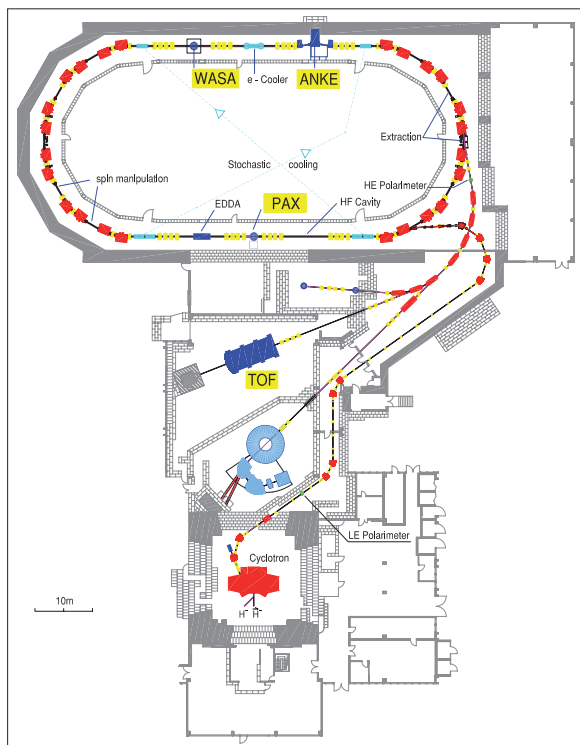

COSY floor plan.

strip detectors in the vacuum next to the target. ANKE also operates a polarised target (ABS) together with a Lamb-shift polarimeter for double-polarisation experiments.

- TOF is an external non-magnetic spectrometer, combining excellent tracking capability with large acceptance and full azimuthal symmetry, allowing the measurement of complete Dalitz plots. TOF is optimised for final states with strangeness. The new straw tube tracker will further improve mass resolution and reconstruction efficiency.
- WASA is an internal  $4\pi$ -spectrometer with large solid angle acceptance. It comprises an electromagnetic calorimeter, a very thin superconducting solenoid, inner and forward trigger and tracking detectors and a pellet target. These allow the measurement of charged and neutral reaction products and their decay products to be carried out exclusively.
- PAX is a new internal set-up at a low- $\beta$  section of COSY, which will use an ABS and a Breit-Rabi polarimeter to study *in-situ* polarisation build-up of a proton beam through spin-filtering.

In addition to hadronic physics studies (hadron spectroscopy, hadronic interactions, symmetries and symmetry breaking), spin manipulation (SPIN-at-COSY) and polarimetry, dEDM investigations are performed. A new high energy electron cooler (2 MeV) will soon be installed. In view of the upcoming FAIR facility, test measurements for HESR/PANDA form a very important aspect of COSY operations.

## GSI, Darmstadt, Germany

The Gesellschaft für Schwerionenforschung (GSI) laboratory is operating a large accelerator complex, consisting of the linear accelerator UNILAC, the heavy-ion synchrotron SIS, the fragment separator FRS for the production and in-flight separation of radioactive nuclei, and the experimental storage-cooler ring ESR. With the UNILAC, ions from p to U can be accelerated up to 12 AMeV, at SIS up to 2 AGeV and, in ESR, stable or radioactive ion beams can be stored and cooled at energies up to 0.56 AGeV (for U). Additionally, secondary pion beams can be delivered at momenta from 0.5 to 2.5 GeV/c.

The accelerators are complemented by about 20 experimental areas, equipped with modern spectrometers and detector systems, which offer outstanding possibilities for research in the fields of hadron and nuclear physics, atomic physics, plasma physics, materials science, biophysics and radiation medicine. The laboratory has thus become a focal point of basic and applied research, offering unique possibilities to scientists from both domestic and foreign universities, and other research institutions.

### 3. Research Infrastructures and Networking

Research highlights from the last decade include, for example: the discovery of the heaviest elements, from  $Z=107$  to 112, and, very recently, the identification of element 114; the identification and study of neutron rich (double magic) nuclei, precision cooling of (radioactive) ion beams to relative momentum spreads below  $10^{-6}$ ; accurate measurements of a range of 350 unknown masses of unstable isotopes of neutron-rich nuclei approaching the  $r$ -process region using the ESR in the electron-cooler or time-of-flight mode; studies of properties of nuclear matter around SIS energies through nucleus-nucleus collisions, including the “caloric curve” of the nuclear liquid-to-gas phase transition in multi-fragmentation, and the mass-shift of kaons in dense nuclear matter from sub-threshold production; the shift of the pion-nucleus coupling constant in nuclear matter from precision spectroscopy of pionic atoms in heavy nuclei; the study of dilepton spectra in elementary  $pp$ ,  $pn$ , in  $p$ -nucleus and in light and medium-heavy nucleus-nucleus systems; precision studies of QED in atomic physics of highly charged ions such as the Lamb-shift in  $U91+$  or the  $1s$   $g$  factor in  $Pb81+$ ; and finally a range of studies in ion-matter interactions, ranging from materials science research using ion track formation to plasma physics with measurements of stopping power and

atomic spectra of ions in high-density matter, to biological research and to the development of heavy-ion cancer therapy.

Equipment dedicated to hadron and (dense) nuclear matter research:

- The  $4\pi$  detector FOPI to study the properties of compressed heated and highly excited nuclear matter. FOPI provides a complete momentum coverage for charged particles emerging from the reaction zone.
- The High-Acceptance Di-Electron Spectrometer HADES to study the properties of vector mesons in nuclear matter.
- A secondary beam facility for pion beams in the 0.5 to 2.5 GeV/c momentum range. Besides complementary experiments in the nuclear matter programme this opens up unprecedented possibilities in the field of medium-energy hadron physics.
- A detector test facility offering mixed electron, proton and pion beams to be used by e.g. the CBM and PANDA collaborations at FAIR.

New opportunities for hadron and (dense) nuclear matter research in the next five years have recently arisen by the successful:

- Replacement of the existing time-of-flight, ToF, barrels

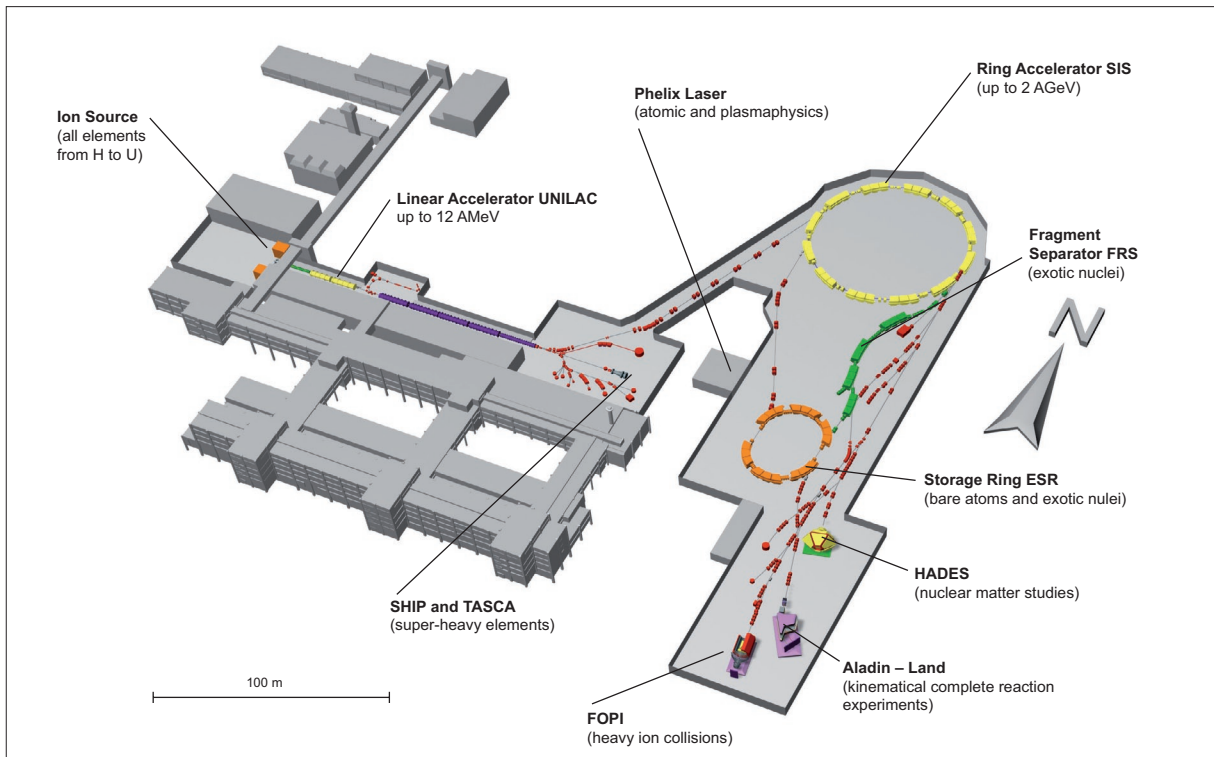

Layout of the existing GSI facility with the UNILAC linear accelerator, the heavy-ion synchrotron SIS18, the fragment separator FRS, the experimental storage ring ESR, and various target areas (see text).

---

at HADES by high-granularity resistive plate counters (RPCs) with significantly improved time resolution ( $\sigma \approx 60\text{-}70$  ps).

- Upgrade of the HADES data acquisition system.
- Allowing 10 times higher event rates and thereby the study of heavy nucleus-nucleus systems, e.g. Au+Au at relativistic energies.

Equipment dedicated to nuclear structure and nuclear astrophysics research:

- The velocity filter SHIP for the separation and detection of super-heavy elements.
- SHIPTRAP, a Penning trap behind the SHIP spectrometer for nuclear structure and atomic physics studies on (heavy) nuclei/atoms.
- A large projectile fragment separator (FRS) for the production and in-flight separation of nuclei far off stability.
- The cooler-storage ring ESR, equipped with powerful stochastic and electron cooling devices, Schottky mass as well as time-of-flight mass spectroscopy for mass measurements of short-lived nuclei, an internal gas-jet target, a collinear laser spectroscopy system and various X-ray and position sensitive particle detectors for in-ring (reaction) experiments.
- A 162-element NaI-crystal ball for  $\gamma$ -spectroscopy of exotic and rare nuclei.
- The RISING (former Euroball) set-up for  $\gamma$  spectroscopy experiments.
- The R3B nuclear reaction set-up to study collective states and complete kinematics reactions with exotic nuclear beams; an upgrade of that facility is presently ongoing.

New opportunities for nuclear structure and astrophysics studies in the next five years:

- A new 28 GHz ECR ion source providing intense U beams for e.g. the heavy element programme at the UNILAC will be available.
- Increase of primary intensities (from presently several  $10^9$  to  $10^{10}$  -  $10^{11}$  U ions /spill; recently the mark of  $2 \times 10^{10}$  U ions was achieved) at SIS; thereby new exotic nuclei and reaction studies will become accessible, in particular in-ring nuclear reaction studies at the ESR.
- The new gas-filled separator TASCAs for heavy element studies, which was completed in 2009, will be fully available.
- The heavy-ion trap facility HITRAP, which is presently being set up behind the ESR, will be fully available.
- The upgraded R3B set-up will be fully available.
- The first AGATA demonstrator detector(s) will be available for novel  $\gamma$  spectroscopy experiments.

Equipment/Projects dedicated to other/multidisciplinary research:

- Experimental stations for atomic physics studies,

channelling investigations with cooled ion beams extracted from the ESR, etc.).

- High power density beam bunches and various equipment for plasma physics research.
- Experimental stations and a cell biology laboratory for research into the radio-biological effects of ion beams.
- Experimental stations and various instrumentation for applications of high and low energy heavy ion beams in materials research and modification (e. g. a heavy-ion microprobe, a diamond anvil cell for irradiating samples under high pressure, diagnostic tools like raster tunnel and raster scanning microscopy, etc.).
- Multipurpose/Test Stations, e.g. for tests of electronic components, or of detectors built for particle/nuclear physics and space missions.

New opportunities for other/multidisciplinary studies in the next five years

- In 2009, a new beam line with three experimental set-ups was installed for users in the field of materials research.
- Through a new collaboration between GSI and ESA, new users in the field of space radiation research have been attracted to GSI adding to the existing user community of biophysics and radiation biology.
- The Kilojoule/Petawatt-Laser PHELIX, including various (Laser light) beam lines to the target areas, will be fully available allowing combined ion and laser beam experiments in plasma physics.

## GANIL, Caen, France

GANIL (Grand Accélérateur National d'Ions Lourds) is a heavy ion accelerator complex delivering both stable heavy-ion beams, ranging from  $^{12}\text{C}$  up to  $^{238}\text{U}$  in the energy range between a few keV to 95 MeV/nucleon, and radioactive beams produced either in flight, or with the ISOL method in the SPIRAL facility. GANIL is one of the foremost sites for exploring both the structure of exotic nuclei and the dynamics of nuclear collisions under various conditions. In addition to nuclear physics, the facility has very strong programmes in atomic and condensed matter physics, and radiobiology. The facility consists of:

- Two injector cyclotrons preceded by two ECR ion sources which can be operated in parallel, one of them being used for low energy experiments in the IRRSUD experimental area, while the other one is used as first acceleration stage for the high energy beam.
- CSS1 and CSS2: separated sector cyclotrons delivering, respectively, beams in experimental area labelled SME in the energy range 5-15 MeV/nucleon and the full energy beams ( $E = 30\text{-}100$  MeV/nucleon) to all experimental areas.

### 3. Research Infrastructures and Networking

---

- SPIRAL: the CIME cyclotron accelerates radioactive beams in the energy domain 2-25 MeV/u.

These secondary beams are produced by the ISOL method using the very intense primary GANIL beam impinging on a thick production target. An intense R&D programme on the target ion source systems is presently in progress, both for SPIRAL1 and for the future SPIRAL2 facility under construction.

The GANIL experimental halls are equipped with a very large range of versatile and state-of-the-art equipment. In particular, GANIL runs three large magnetic spectrometers:

- VAMOS is a large acceptance spectrometer and is used for various types of experiments: for the spectroscopy of single particle and collective states of exotic nuclei using direct and deep inelastic reactions, fusion-evaporation reactions, and the use of the Recoil Decay Tagging method to characterise heavy nuclei. It was built within a European collaboration (UK, Germany, France), and was supported by a European RTD programme. The focal plane detection system is presently undergoing an important upgrade.
- The high-resolution spectrometer, SPEG, which has been intensively used for the study of discrete nuclear states, mass measurements of exotic nuclei, and the general study of nuclear excitations in peripheral collisions.
- The LISE III spectrometer, mainly used today for experiments with radioactive beams produced “in-flight” on the production target located at the entrance of the spectrometer, which then isolates the projectile fragments from the enormous flux of the incident beam, focuses and unambiguously identifies them. An additional velocity selection is obtained from a Wien filter. Finally, the last magnetic dipole transforms the whole apparatus into a genuine mass spectrometer.

The variety of other detectors at GANIL are used for investigations on exotic nuclei and highly excited nuclei:

- The EXOGAM array is a large solid angle, high efficiency  $\gamma$  detector, specially designed for RIB but also exploited with high intensity beams. It was financed through a large international collaboration.
- MUST2/TIARA: modular charged-particle detector consisting of solid state detector telescopes. It is dedicated to the study of direct reactions induced by radioactive beams impinging on light targets. These detectors are often coupled with one of the spectrometers and with EXOGAM.

Apart from these versatile devices, the GANIL experimental area offers a variety of equipment for the detection of all types of particles: INDRA, a  $4\pi$  multi-detector for charged particles, the Chateau de Crystal for  $\gamma$ 's, the

Neutron Wall, and the MAYA active target-detector, to name just a few.

In addition, three beam lines are now available for Atomic and Condensed Matter Physics, at very low energy (below 1 MeV/nucleon, after the injector cyclotrons), at medium energy (after CSS1) and at full energy, allowing for a broad range of experiments. A special beam line is also devoted to industrial applications, and to biological research. This activity has been considerably increased in the last few years, with the creation of a new laboratory dedicated to radiobiology inside the GANIL campus, and with special efforts to attract new industrial partners. The radiobiology activities are expected to grow at GANIL in the coming years, before the new hadron therapy facility ARCHADE comes into operation. In total, between 50 to 60% of GANIL beam time (around 10000 hours) is allocated to interdisciplinary research and to applications, some with major potential implications for society: nuclear waste management, ageing of materials in nuclear power plants, radiobiology with heavy projectiles. Two types of industrial partners are particularly interested in the opportunities offered by GANIL's heavy ion beams: companies or agencies involved in the construction of electronic components for space applications (CNES, ESA, EADS, JAXA), and those building microporous films and membranes, or microstructures based on the development of this technology.

GANIL is thus a unique centre in Europe for studying interaction between ions and matter and is a host laboratory for a large community of around 700 users from more than 100 laboratories and 30 countries. The SPIRAL2 project presently under construction within a broad international collaboration will strengthen the European leadership in the field of exotic nuclei, and opens the road towards EURISOL, for which GANIL has been identified as a possible site.

The number of permanent staff is slightly above 250, while the number of students and post-docs is on average above 30. The average number of publications related to GANIL experiments is around 150 per year, out of which more than half are published in refereed reviews. The annual budget (without manpower) reaches 9.4 M€, out of which 7.4 M€ come from the 2 funding institutions, CNRS/IN2P3 and CEA/DSM. A recent study on the socio-economical impact of GANIL on the region showed that GANIL indirectly generated more than 350 jobs, and injects more than 32 M€ into the local economy each year, through the salaries of its employees and its running costs. It was estimated that every € that is invested in GANIL by the Region of Basse Normandie is recovered locally within 3 years.



---

## IPN, Orsay, France

The ALTO facility can deliver radioactive beams, stable beams and cluster beams in the same place for nuclear structure, atomic physics, cluster physics, biology and nanotechnology.

### Tandem Accelerator:

The Orsay Tandem Van de Graff accelerator is of the MP type. Its nominal voltage is 15 MV and it is usually operated up to 14.6 MV. Stable ion beams range from protons to gold can be delivered. "Cluster-beams" and micro-droplets are also routinely delivered. Intense cluster beams (C60 and gold droplets) and rare ion beams ( $^{14}\text{C}$ ,  $^{48}\text{Ca}$ ...) are available.

### ALTO:

The ALTO accelerator is an electron accelerator (50 MeV, 10  $\mu\text{A}$ ) used as a driver to induce fission in a thick heated uranium carbide target. The number of fissions reached in the target is  $10^{11}$  fissions per second. These beams are of great interest for the study of nuclear structure, decay heat in reactors and solid state physics. Research and development on target and ion sources for future second-generation radioactive ion beam projects (SPIRAL2, EURISOL...) is also at the heart of activities at ALTO.

### The associated research instrumentation:

- PARRNe is an ISOL beam line (with up to 5 lines) dedicated to the study of very neutron rich nuclei produced by fission (neutron induced or photo-fission). Fast tape transport systems are available for studying short-lived nuclei. Several target-ion source ensembles are being developed at the facility: surface ionisation, laser ion source, febiad ion source...
- BACCHUS is a  $180^\circ$  magnetic spectrometer designed to suppress the primary beam. This spectrometer is mainly dedicated to heavy ions studies.
- Split Pole is a magnetic spectrometer used for the detection and the measurement of the momenta of charged particles in two-body reactions with a very high resolution. This spectrometer is intensively used for nuclear astrophysical studies.
- ORGAM is a Ge multi-detector associated with the Split Pole spectrometer and ancillary charged particle detectors for the study of deep inelastic reactions and fusion evaporation.
- OSCAR (Orsay Segmented Clover Array) is a Ge detector consisting of 4 Ge clovers placed in close geometry to study low multiplicity decays of very exotic nuclei.
- AGAT is a new generation detection apparatus used in Cluster Physics developed at the ALTO facility. This set-up is mainly used for atomic astrophysical studies.

- DIESE, DIESE X, ESKIMO are dedicated set-ups for irradiation with cluster beams (CnHm, C60, Aun).
- SIHL is an off-line separator dedicated to tests of, and the R&D on, target ion sources used at PARRNe.

### Services currently offered by the infrastructure:

- The Detector Laboratory at IPN Orsay is among the most advanced laboratories in Europe for testing and repairing large volume HPGe detectors for  $\gamma$  arrays. ALTO is the home base of the French – UK Ge pool.
- The Target Laboratory at IPN Orsay for the production of thin films to be used as targets in nuclear physics experiments, solid state physics and applied research.
- The Experimental Hall services at the ALTO facility (25 engineers and technicians) provide the technical assistance for the installation of new set-ups in the experimental areas, and the maintenance of vacuum and electrical components for existing apparatus.
- Computer centres and Data Acquisition services.
- Safety and security services.

A Laser laboratory is installed at the ALTO facility in order to test the new ionisation scheme for the production of very pure radioactive ion beams.

The ALTO facility has a long tradition to work with different community of physics research such as atomic physics, solid state physics, accelerator physics, nuclear physics, particle physics, nanotechnology, interaction of ion with matter, and biology.

## ISOLDE at CERN, Geneva, Switzerland

The ISOLDE facility is situated at the PS-Booster accelerator at CERN. The 1.4 GeV proton beam with average intensity of 2  $\mu\text{A}$  produces radioactive isotopes in various targets. The high proton energy and the accumulated target and ion-source knowledge allow extracting and separating about 700 different isotopes of more than 70 elements; this number of isotopes available for users is by far the highest at any ISOL facility worldwide (see figure next page). A substantial and rapidly increasing fraction of the radioactive isotopes has been accelerated up to 3 MeV/u with the REX-ISOLDE post-accelerator. Although originally designed only for acceleration of ions with mass number up to 60, it has been proven that REX-ISOLDE can operate all the way up to mass number 238, thereby increasing drastically the physics reach of the installation.

An active beam development programme improves continuously on the number of radioactive beams and their intensity and isotopic and isobaric purity. A major upgrade of the laser ion source (RILIS) has taken place in 2008. This gives new possibilities for radioactive beam production and drastically improves the intensity and

### 3. Research Infrastructures and Networking

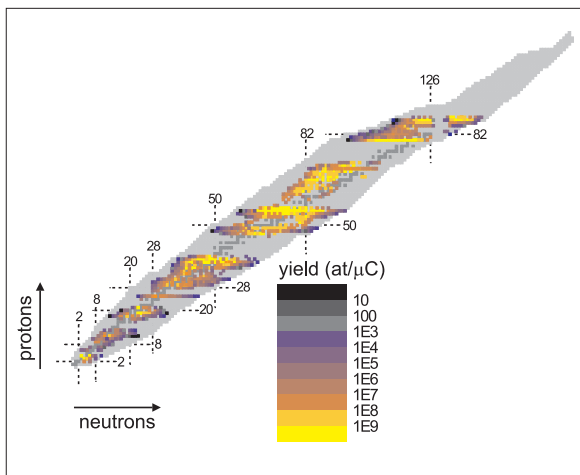

Yields for nuclear isotope production as a function of RIB accumulated beam charge (in atoms per  $\mu\text{C}$ ).

purity of many beams. Further beam improvements have followed from the commissioning in 2008 of ISCOOL, an RFQ beam cooler which provides bunched and cooled beams that drastically improves the sensitivity for laser spectroscopy measurements. The diversity of beams and their quality will therefore increase significantly over the next few years; in particular what concerns post accelerated beams.

Present experiments mainly deal with nuclear structure questions, explored via measurements of ground state properties (mass, radii, moments), via decay studies or Coulomb excitation and transfer reaction studies at low energy. A sizeable part of the programme is devoted to other fields, such as nuclear astrophysics, and fundamental physics. Close to 20% the beam time is devoted to solid state physics and life sciences with broad societal benefits.

The installations at ISOLDE include two mass separators, various beamlines for experiments including a ultra-high vacuum beamline, the REX-ISOLDE post-accelerator and shielded collection points and special laboratories for the handling of radioactive samples.

A new dedicated laboratory for condensed matter physics studies has been constructed during 2007, apart from solid state physics this is also used by biochemistry groups and it is open to the whole user community. The existing experimental set-ups include a large variety of auxiliary equipment for nuclear spectroscopy, precision decay measurements and for solid state physics. New instrumentation being currently installed includes a beta-NMR platform for nuclear and solid state physics with polarised radionuclides and a new laser spectroscopy set-up CRIS for low intensity bunched beams.

There are close to 400 users per year at ISOLDE, a number that is increasing currently in particular due to new users at REX-ISOLDE and Miniball. The general increase of interest in the infrastructure is also reflected in the recent increase in the membership of the ISOLDE collaboration (the body that officially represents ISOLDE at CERN through a Memorandum of Understanding) from 9 to 14 member states and negotiations are ongoing with several additional countries.

#### ALICE at CERN, Geneva, Switzerland

The ALICE Collaboration (31 countries, 111 institutes and over 1 000 collaborators) has built at CERN a dedicated multi-purpose heavy-ion detector to exploit the unique physics potential of nucleus-nucleus interactions at Large Hadron Collider (LHC) energies. It is the largest nuclear physics experiment in the world.

The aim of ALICE is to study the physics of strongly interacting matter at extreme energy densities, where the formation of a new phase of matter, the Quark-Gluon Plasma (QGP), is expected.

The existence of such a phase and its properties are key issues in the physics of the strong interaction (Quantum Chromodynamics, QCD) for the understanding of the fundamental phenomena of quark-confinement and chiral-symmetry restoration. For this purpose, a comprehensive study of the hadrons, electrons, muons and photons produced in the collision of heavy nuclei is required utilising a variety of beams at various energies. ALICE will also study proton-proton collisions, both as a comparison with lead-lead collisions and in physics areas where ALICE is competitive with other LHC experiments.

Beam operations have started in 2010 with proton-proton collisions at energies in the centre-of-mass system of 900 GeV, 2.36 TeV and 7 TeV. An increase



The figure shows part of the ALICE Collaboration, 60 m underground, in front of the ALICE detector at CERN.

in available energy by a factor of 2 will take place from 2012. The heavy ion programme with Pb+Pb collisions has commenced in November 2010 at centre-of-mass energies approx. a factor of 15 higher than at the only other nuclear collider, RHIC in the USA.

The full measurement programme will take place over more than a decade and will require the study of heavy ion reactions with ions of different masses and at various energies, and the development of a proton-ion collision programme.

ALICE has initiated a vigorous and ambitious upgrade programme to enlarge the capabilities of this unique detector facility and its physics reach. These involve increasing the capabilities for tracking and particle identification (already a particular strength of ALICE as compared to other LHC detectors) and for jet reconstruction, and starting low-x physics measurements at high rapidity for studies of the Colour Glass Condensate. The extensive detector upgrades will include building a new inner tracker based on state-of-the-art silicon technology, extending Cherenkov and calorimetry coverage, increasing the rate capability of the entire detector for physics with rare probes, and building a new tracking calorimeter system at small angles to the beam direction.

### **Antiproton Decelerator AD at CERN, Geneva, Switzerland**

The Antiproton Decelerator (AD) at CERN was commissioned in 2000 and has been providing low-energy (100 MeV/c) antiprotons to a number of experiments since then. The goal of these experiments has been to study (and to develop the techniques to produce) cold antihydrogen atoms (for tests of CPT and of the weak equivalence principle), to study the spectroscopy of antiprotonic helium in view of determining with high precision the parameters of antiprotons and fundamental constants, and to study the effects of antiprotons on biological ensembles.

In a first phase (2000-2005), the ATHENA and ATRAP experiments perfected the techniques to synthesise (for the first time) and characterise slow antihydrogen atoms. ASACUSA has carried out a very thorough series of measurements of the transition energies of antiprotonic helium, and used this information to strongly constrain any differences between protons and antiprotons, in addition to measuring interactions between very low-energy antiprotons and matter. Finally, the ACE experiment demonstrated for the first time a considerably stronger biological effect of antiprotons in living tissue than is the case for protons.

In a second phase (2006-present), the ATRAP and ALPHA experiments are taking the next steps towards



The AD hall experiments with the ASACUSA, ATRAP and ALPHA collaborations.

trapping of antihydrogen atoms, such as improved anti-proton capture rates, the production of cold electron and positron plasmas, low temperature preparation and mixing of positron and anti-proton plasmas, including the successful demonstration of evaporative cooling for anti-protons. Once trapped, the goal remains of subsequently cooling the antihydrogen atoms, and carrying out first spectroscopic measurements, an endeavour that requires painstaking efforts, both technical as well as experimental, and that is constrained by the limited number of available antiprotons. ASACUSA continues to perfect their spectroscopic measurements on antiprotonic helium. The sensitivity of this method has allowed ASACUSA to reach an impressive level of precision in the determination of fundamental constants, such as the electron to anti-proton mass ratio and the anti-proton magnetic moment. In addition, this experiment is also laying the groundwork towards producing a beam of antihydrogen, in view of measuring the hyperfine splitting of ground-state antihydrogen. Finally, a new experiment, AEGIS, has been approved to attempt to measure, also with a beam of antihydrogen atoms, the gravitational coupling between matter and antimatter. Also these experiments would benefit from an increase in the number of very low energy antiprotons, currently limited by the need to degrade the energy of the antiprotons delivered from the AD (100 MeV/c) down to the keV range that allows trapping.

The present approved programme of the AD extends until the end of 2016; to meet the increasing need for antiprotons both by the approved experiments as well as to permit further experiments to take place. An addition to the AD, a further deceleration stage down to 100 keV called ELENA, is presently under discussion. The scientific committee in charge of the AD programme (the CERN SPSC) has recognised the substantial potential impact of ELENA on the AD experimental programme,



### 3. Research Infrastructures and Networking

and has welcomed recent studies of the possible integration scenarios of ELENA into the existing complex, which would minimise the disruption to the ongoing experiments while also maximising the floor space available for new experimental beam lines. These scenarios also provide sufficient space to allow for possible further upgrades to ELENA, including in particular the possibility of a slow extraction. The SPSC has recommended that the potential for such a future upgrade option be maintained in the detailed design of ELENA.

In light of the strong support expressed by the SPSC to the ELENA proposal and its encouragement to proceed towards a detailed TDR and full funding of the project, CERN's Research Board has in a first step acknowledged the scientific motivation for ELENA; it is expected that a formal decision on the project will be arrived at in the course of 2010.

#### INFN-LNL, Legnaro, Italy

LNL is one of the four national facilities funded by INFN with the mission of providing research infrastructures for nuclear physics research for Italian and foreign users. The main research area is on nuclear structure and reaction dynamics, using heavy ion beams provided by the 15 MV Tandem and by the ALPI superconductive LINAC, the latter either coupled to the Tandem or to the heavy ion injector PIAVE. Applied and interdisciplinary physics is also an important activity, making use mainly of beams delivered by the 7 MV CN and 2 MV AN200 accelerators. Nuclear structure and reaction dynamics studies at bombarding energies close to the Coulomb barrier are based on dedicated instrumentation developed during the last years, i.e. large  $\gamma$  arrays, magnetic spectrometers and particle detector arrays. In nuclear spectroscopy (for which the first built and extensively used dedicated apparatus is GASP), investigations are being performed on high spin physics, nuclear structure at finite temperature, symmetry properties of nuclei, shell stabilisation and quenching, both at the proton rich and neutron rich side of the nuclear chart. The study of reaction mechanisms are focused on near and sub-barrier fusion reactions, elastic, inelastic and multinucleon transfer, break-up processes, nuclear temperature studies at low bombarding energies. Multi-nucleon transfer and deep inelastic reactions are employed to investigate the properties of neutron rich nuclei using stable beams. This is achieved by coupling the large solid angle magnetic spectrometer PRISMA to arrays for  $\gamma$  spectroscopy. In this connection, the large  $\gamma$  array CLARA was used first; it has recently been replaced by the AGATA demonstrator. Via  $\gamma$ -particle coincidences new measurements were performed providing information on excited states of neutron rich nuclei, including in many cases their life-

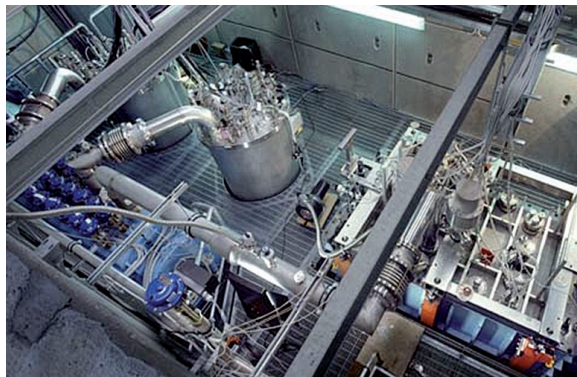

The PIAVE accelerator at INFN-LNL in Legnaro.

times. These studies are probing effective interactions and the collective and single particle properties of nuclear systems by varying proton and neutron numbers. With the AGATA demonstrator, a wide physics programme is pursued, involving a large user community from Europe and other parts of the world. The AGATA experimental campaign at LNL will pave the way to future work at radioactive ion beams facilities.

In connection with the study of nuclei at finite temperature of the onset of multifragmentation (mostly performed with the GARFIELD setup), there is also an intense R&D activity related to the construction of new detector arrays. In particular, within the FAZIA initiative, every effort is made to improve the mass and charge resolutions of silicon detectors through the study of channeling effects.

With the long-term goal to study parity non-conservation effects in heavy alkalis and finding possible deviations from standard model predictions, a research programme is being carried out to produce, via fusion evaporation reactions, Fr isotopes, which are extracted and delivered to a magneto-optical trap. Carrying out measurements on a chain of isotopes and improving the efficiency of the optical atom trap are the main aims prior to performing precision parity test measurements.

At the smaller LNL accelerators, nuclear techniques as for instance high-precision analysis and characterization of materials via Rutherford backscattering or PIXE, are presently used and will be further improved in the forthcoming years. The research performed at LNL on radio-biological effects is important also for its applications in the study of cellular and molecular responses to radiation. Increasing effort is being made regarding tumour radiation therapy using neutrons, protons and light ions. Studies are in progress to develop *ad hoc* mini detectors with possible applications for Boron Neutron Capture Therapy.



The research in the accelerator field is mainly focused on the production of high-intensity proton and deuteron beams and on linear accelerator developments. It is done in international collaborations such as EURISOL.

### INFN-LNS, Catania, Italy

The Laboratori Nazionali del Sud (LNS) is operated by INFN; it runs two accelerators: an electrostatic Tandem, 15 MV maximum terminal voltage, and a K=800 Superconducting Cyclotron (CS). These two accelerators provide a large variety of ions and energies. Moreover, the two accelerators can be operated in a coupled scheme (CS as driver and Tandem as main accelerator) to produce low energy (few MeV/nucleon), low intensity, light radioactive ion beams (RIBs). This facility (EXCYT) has been in operation since mid-2006 and, up to now, provided  ${}^8,9\text{Li}$  beams, with a maximum intensity of  $7 \cdot 10^4$  particles per second (pps) for  ${}^8\text{Li}$ . New beams such as  ${}^{15}\text{O}$  with about  $5 \cdot 10^5$  pps, are under development. The expertise gained with the EXCYT design and operation allowed establishing collaborations for the SPES and SPIRAL2 facilities. At LNS, RIBs produced by in-flight fragmentation of the intermediate energy CS beams are also available; the facility has been named FRIBs. As an example,  ${}^{18}\text{Ne}$  beams at about 35 MeV/nucleon are produced with maximum intensity of  $9 \cdot 10^4$  pps. FRIBs uses the CS beam transport line to select the produced ions and a tagging method is applied to identify the relevant projectiles. An upgrade of FRIBs is planned; it will increase the available yields approximately 30 times.

The facilities at LNS are mainly devoted to research in fundamental nuclear physics, i.e. reaction mechanisms and dynamics, nuclear structure and nuclear astrophysics. Recent work relates to: i) two-proton decay from excited states of light nuclei; ii) constraining the nuclear symmetry potential from measurements of heavy ion

collisions; iii) measurements of Big Bang and r-process nucleosynthesis reactions with stable and radioactive beams iv) exclusive measurements of high energy  $\gamma$ -rays to investigate isospin effects in reaction dynamics. In addition, a lively interdisciplinary research activity, including safeguard of Cultural Heritage masterpieces (LANDIS laboratory), hadron therapy (CATANA facility) and radiation hardness, is being performed. Of relevance is also the R&D activity related to accelerators and associated equipment. In particular, thanks to the R&D on ECR ion sources, high-performance sources have been developed such as SERSE, presently injecting into the CS, and TRIPS, developed for the TRASCO project and now installed at LNL.

The average number of users at LANL is about 220 per year, with about 40% coming from outside of Italy. Examples of the top level experimental equipment available at LNS are:

- CHIMERA, a  $4\pi$  apparatus consisting of about 1200 telescopes, recently upgraded to lower thresholds for mass and charge identification of ions in a wide range of masses. It is mainly devoted to studies involving a large number of reaction products (i.e. multifragmentation), but its large solid angle coverage makes it particularly suited also for measurements with low intensity radioactive beams.
- MEDEA-SOLE-MACISTE, where a 180 BaF<sub>2</sub> ball and a superconducting solenoid and focal plane detector are jointly operated to detect high energy  $\gamma$  rays, light charged particles and heavy fragments at forward angles. The system is particularly suited for studying GDR properties and pre-equilibrium processes at intermediate energy. An upgrade to detect neutrons is under way.
- MAGNEX, a recently commissioned large acceptance magnetic spectrometer, specifically designed for RIB experiments. It is now used to perform a broad physics programme ranging from nuclear structure to nuclear astrophysics.



The magnetic spectrometer MAGNEX at LNS.

### Neutron Facilities in Europe

In Europe several major and a number of smaller-scale neutron facilities are successfully operated (see <http://idb.neutron-eu.net/facilities.php>). They are embedded in a large number of neutron facilities worldwide (see <http://www.ncnr.nist.gov/nsources.html>). Mostly these facilities are exploited in materials science and biological research, but some of them have also a strong nuclear physics, atomic physics and fundamental particle physics scientific programme. This includes the Institute Laue Langevin (ILL) in Grenoble, France, where a high neutron flux reactor feeds several beamlines, the pulsed spallation source ISIS in Chilton, UK, which features two target stations with a multitude of ports each, the con-

## 3. Research Infrastructures and Networking



Artist's view of the European Spallation Source, ESS, in Lund, Sweden.

tinuous spallation source at the Paul Scherrer Institute (PSI) in Villigen, Switzerland, where also a separate cold neutron source is available, the research reactor FRM II in Munich, Germany, as well as a number of smaller reactors such as TRIGA systems at universities. CERN operates the nTOF facility mainly for nuclear science.

Spallation sources have the advantage that they can also provide muons, which enrich the possibilities to perform condensed matter research with complementary methods at one site and which, in principle, offer novel possibilities such as combining muons with produced radioactive isotopes to form radioactive muonic atoms, where muonic x-rays may be used to derive nuclear parameters.

Recently, the European Research Ministers have decided to build jointly the ESFRI recommended European Spallation Source Scandinavia (ESSS) in Lund. Although the site has been decided, the machine concept is still open. A multi MW proton beam will put the facility in direct competition with the American Spallation Neutron Source in Oak Ridge, USA. The options in Lund are long or short pulses, where the long-pulse option reduces the demands on the targets and the short-pulse scenario would be more attractive for fundamental physics. Presently the design options are being fixed and it depends on the potential user community whether they want to push for ultra cold muon stations, radioactive isotope ports and muon beams.

### 3.1.4 Smaller-Scale Facilities

The European Large-Scale Facilities presented above have been, and will be, of primary impact on nuclear physics. Nonetheless, the contribution of Smaller-Scale Facilities (SSFs) to almost all domains of nuclear physics, and its applications, continues to be of great importance as pointed out in various chapters of this Long Range Plan. These Smaller-Scale Facilities, whether national or regional, usually carry out a diverse research programme in nuclear science and its applications and are often strongly supported by national funding agencies, because of their important role in education and because novel technologies and methodologies are being developed there to the benefit of the respective countries.

The smaller-scale facilities in Europe comprise a large set of installations, offering the European nuclear physics community a large variety of stable beams, an impressive number of unique instrumentation and the possibility to carry out forefront research using those beams and various experimental methods. A list of the most important European smaller-scale facilities is given in the table below, together with the accelerator specifications.

A number of the facilities listed in the table below carry out activities devoted to both basic and applied nuclear research. Most of the basic research carried out at facilities providing ions at low energies is related to nuclear structure and reaction, and nuclear astrophysics problems. Usually the working environment at these facilities allows developing novel experimental methods and techniques and to perform measurements well integrated in the scientific scope of the large-scale facilities. This particularly applies to: 1) the Maier-Leibnitz-Laboratory, GARCHING, 2) the Institute für Kernphysik, Universität KÖLN, 3) the IFIN-HH at BUCHAREST, 4) the Institute of Nuclear Research, ATOMKI, DEBRECEN, 5) the SAFE, OSLO Cyclotron Laboratory, 6) the Nuclear Physics Institute, NPI, REZ near PRAGUE, 7) the Heavy Ion Laboratory, HIL, University of WARSAW, 8) the Rudjer Boskovic Institute, RBI, ZAGREB, and 9) Demokritos (NCSR), ATHENS. The latter has also a facility producing mono-energetic neutrons (with energies up to 14.5 MeV) with fluences ranging from  $5 \times 10^5$  to  $10^7$  for astrophysics experiments and applications.

With electrons and photons, very remarkable results are obtained when specific aspects of nuclear structure are investigated that correspond to nucleon configurations preferably accessed by photon beams. This applies to the research performed at the Institutes for Nuclear Physics at the Technical Universities in DARMSTADT and DRESDEN, and the Forschungszentrum Dresden, FZD.

Concerning the facilities mainly focusing on applied research, the use of ion beams and nuclear techniques is rather wide spread and has led to important results in atomic physics, materials science and micro-fabrication. In addition, nuclear spectroscopy with charged particles, hyperfine interactions in solids, and diffusion of radiotracers in materials are the main activities at separation and implantation facilities. Advances in these fields have been

obtained at: 1) the Helmholtz Institut für Strahlen- und Kernphysik, Universität BONN, 2) the Physikalisches Institut, Universität GÖTTINGEN, and 3) the Centro de Microanálisis de Materiales, Universidad Autónoma de MADRID. The latter also has a programme in archeometry, while LABEC (Florence) and VERA (Vienna) are laboratories mainly devoted to applications for cultural heritage by performing Accelerator Mass Spectrometry (AMS).

| Town                 | Institute   | Facility              | Characteristics   |
|----------------------|---|-----------------------|---|
| Athens (GR)          | National Centre for Scientific Research               | DEMOKRITOS            | 5.5 MV Tandem Van de Graaff   |
| Bochum (DE)          | Central Unit for Ion Beams                            | RUBION                | 4.5 MV Tandem   |
| Bonn (DE)            | Helmholtz Institut für Strahlen- und Kernphysik       |                       | Separator and Implanter   |
| Bordeaux (FR)        | CNRS-IN2P3 and University Bordeaux 1                  | AIFIRA                | 3.5 MV Singletron, 4 MV Van de Graaff                                       |
| Bucharest (RO)       | National Institute of Physics and Nuclear Engineering | IFIN-HH               | 9 MV FN Tandem  |
| Caen (FR)            | CIMAP at GANIL  | IRRSUD                | K=30 Injector Cyclotrons  |
| Darmstadt (DE)       | Technische Universität                                | S-DALINAC             | SC Electron Linac 3-130 MeV   |
| Debrecen (HU)        | Institute for Nuclear Research                        | ATOMKI                | K=20 Cyclotron  |
| Dresden (DE)         | Forschungszentrum Dresden - Rossendorf                | ELBE, Ion Beam Centre | SC e Linac 12-40 MeV, 5 MV Tandem, 6 MV Tandron                             |
| Florence (IT)        | Laboratorio di Tecniche Nucleari per i Beni Culturali | LABEC                 | 3 MV Tandem   |
| Garching (DE)        | LMU & TU München                                      | Maier-Leibnitz-Labor  | 15 MV MP Tandem   |
| Göttingen (DE)       | II. Physikalische Institut                            |                       | 3 MV Tandem, Implanter  |
| Heidelberg (DE)      | Max-Planck-Institut für Kernphysik                    |                       | 12 MV Tandem, 24 MV Booster, TSR, CSR                                       |
| Köln (DE)            | Institut für Kernphysik                               |                       | 10 MV FN Tandem   |
| Krakov (PL)          | Henryk Niewodniczanski Institute of Nuclear Physics   | IFJ PAN               | 3 MV Van de Graff 60 MeV and 230 MeV (under construction) proton cyclotrons |
| Leuven (BE)          | KU Leuven   |                       | 1.7 MV Tandem   |
| Ljubljana (SI)       | Jozef Stefan Institute                                | JSI                   | 2 MV Tandetron  |
| Madrid (ES)          | Centro de Microanálisis de Materiales                 | CMAM                  | 5MV Tandetron   |
| Oslo (NO)            | Oslo Cyclotron Laboratory                             | SAFE                  | MC-35 Cyclotron   |
| Rez near Prague (CZ) | Nuclear Physics Institute                             |                       | K=40 Isochronous Cyclotron  |
| Sevilla (ES)         | Centro Nacional de Aceleradores                       | CNA                   | 3 MV Tandem   |
| Surrey (UK)          | Surrey Ion Beam Centre                                |                       | 2 MV Tandem   |
| Warsaw (PL)          | University of Warsaw                                  | HIL                   | K=160 Heavy Ion Cyclotron, GE-PET trace 8 cyclotron                         |
| Vienna (AU)          | Universität Wien                                      | VERA                  | 3 MV Pelletron Tandem   |
| Zagreb (HR)          | Rudjer Boskovic Institute                             | RBI                   | 6 MV EN Tandem  |

## 3. Research Infrastructures and Networking

Particular emphasis to medical applications is given at Centro Nacional de Aceleradores, CNA, University of Seville, where radionuclides for PET are produced. Similar techniques are developed at HIL, Warsaw, with the cyclotron GE-PETtrace 8 to be operational in 2011. At the The Henryk Niewodniczanski Institute of Nuclear Physics PAN, IFJ PAN in KRAKOW, a new cyclotron for the acceleration of protons up to 230 MeV is being installed for proton therapy, nuclear physics research and other applications.

A number of SSFs are organised in FP7 IA Joint Research Activities (JRAs) and Networks. Eight institutions from central and southeast Europe collaborate in the EWIRA (East-West Integrating Research Activity) JRA of ENSAR to integrate the research communities of their laboratories, and their nuclear research programmes, into the European Research Area and thus provide the opportunity for developing nuclear science across all of Europe. The EWIRA institutions are: NCSR “Demokritos”, Athens; IFIN-HH, Bucharest; ATOMKI, Debrecen; NPI, Rez near Prague; HIL, Warsaw; RBI, Zagreb; INRNE, Sofia; and IFJ-PAN, Krakow.

These networking activities need to be continued in the future to enhance the inter-laboratory cooperation in Europe, with an emphasis on smaller-scale laboratories in central and southeast Europe that provide advanced testing equipment and promote the development of novel experimental techniques.

Concerning nuclear physics applications, SPIRIT (Support of Public and Industrial Research using Ion beam Technology) has been formed as an FP7 Integrating Activity project grouping seven SSFs with leading ion beam facilities, and four research providers from seven EU Member States and one Associated State. The seven partners providing Trans-National Access supply ions in an energy range from ~10 keV to 100 MeV for modification and analysis of solid surfaces, interfaces, thin films and nanostructured systems. The techniques cover materials, biomedical and environmental research and technology, and are complementary to the existing synchrotron and neutron radiation networks.

The collaboration of smaller-scale facilities should be strongly supported in the forthcoming EU Framework Programme 8. Integrating Activities are of vital importance for the development of these laboratories, both with regard to improving the performance of their own accelerator facilities and the development of novel instrumentation to be used at the next generation of European large-scale facilities such as FAIR and SPIRAL2.

### 3.2 Future Research Infrastructures

In this chapter, we present the nuclear ESFRI facilities, under construction or planned, major upgrades of existing facilities and plans for the future.

#### 3.2.1 ESFRI Roadmap Facilities

Construction of the two large-scale nuclear physics facilities FAIR and SPIRAL2, which were identified as the European top priorities in Nuclear Physics on the 2005 and 2008 ESFRI lists, has started or will begin soon.

##### FAIR, Darmstadt, Germany

The Facility for Antiproton and Ion Research, FAIR, in Darmstadt, Germany, will provide worldwide unique accelerator and experimental facilities allowing for a large variety of unprecedented forefront research in physics and applied science. Indeed, it is the largest basic research project on the roadmap of the European Strategy Forum of Research Infrastructures (ESFRI), and is a cornerstone of the European Research Area. FAIR offers an abundance of outstanding research opportunities to scientists from the whole world, broader in scope than any other contemporary large-scale facility such as FRIB in the USA or J-PARC in Japan.

The main focus of FAIR research is on the structure and evolution of matter on both a microscopic and on a cosmic scale – deepening our understanding of fundamental questions like:

- How does the complex structure of matter at all levels arise from the basic constituents and the fundamental interactions?
- How can the structure of hadronic matter be deduced from the strong interaction? In particular, what is the origin of hadron masses?
- What is the structure of matter under the extreme conditions of temperature and density found in astrophysical objects?
- What were the evolution and the composition of matter in the early Universe?
- What is the origin of the elements in the Universe?

The FAIR research programme was approved by the International Steering Committee of FAIR (ISC) in 2006. It includes 14 initial experiments, which form the four scientific pillars of FAIR (in alphabetical order):

- APPA: Atomic and plasma physics, and applied sciences in the bio, medical, and materials sciences.
- CBM: Physics of hadrons and quarks in compressed nuclear matter, hypernuclear matter.
- NuSTAR: Structure of nuclei, physics of nuclear reac-



tions, nuclear astrophysics and radioactive ion beams (RIBs).

- PANDA: Hadron structure and spectroscopy, strange and charm physics, hypernuclear physics with anti-proton beams.

After the official launch of the project on 7 November 2007, the FAIR scientific community and the partner countries are eager to see FAIR materialise. In order to enable an expeditious start of the FAIR construction, the FAIR Joint Core Team (FJCT) and the Scientific and Technical Issues Working Group (STI) were mandated by the ISC to prepare a proposal for a start version accounting for recent cost estimates and the firm funding commitments while securing top scientific excellence and the outstanding discovery potential of the facility. For this purpose the start version, as agreed upon in 2007, is now structured in six modules:

- Module 0: Heavy-Ion Synchrotron SIS100 – basis and core facility of FAIR – required for all science programmes.
- Module 1: CBM/HADES cave, experimental hall for APPA and detector calibrations.
- Module 2: Super-FRS for NuSTAR.
- Module 3: Antiproton facility for PANDA, providing further options also for NuSTAR ring physics.
- Module 4: Second cave for NuSTAR, NESR storage ring for NuSTAR and APPA, building for antimatter programme FLAIR.
- Module 5: RESR storage ring for higher beam intensity for PANDA and parallel operation with NuSTAR.

A future Module 6 will include the superconducting Heavy-Ion Synchrotron SIS300, the high voltage electron cooler for the HESR and the electron ring for collider mode of NESR.

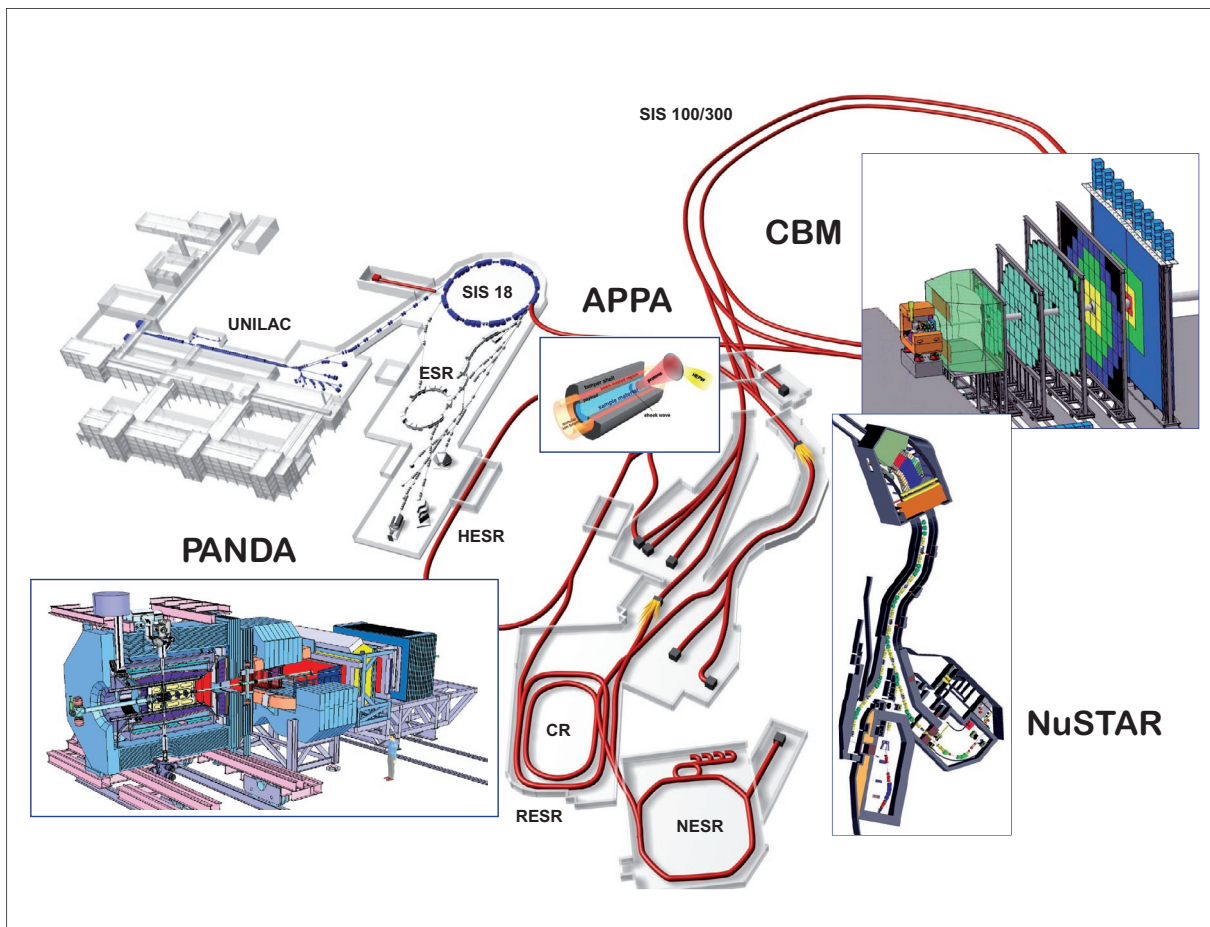

The FAIR accelerator/storage ring complex and the large experiments APPA, CBM, NuSTAR (including the Super-FRS) and PANDA (at the antiproton accelerator/storage ring HESR). GSI's UNILAC and SIS18 will serve as injectors into the SIS100/300 synchrotrons. Antiprotons or radioactive isotopes will be collected in CR, accumulated in RESR and accelerated or decelerated and stored in HESR and NESR.

### 3. Research Infrastructures and Networking

---

Based on recent cost estimates and the firm commitments on funding of FAIR Member States, the new Start Version is comprised of Modules 0 – 1 – 2 – 3, in the following called the Modularised Start Version. This Modularised Start Version provides for outstanding and world-leading research programmes in all four scientific areas. They will push the frontiers of our knowledge in hadron, nuclear, atomic and applied physics far ahead, with important implications also for other fields in science such as cosmology, astrophysics, particle physics, and technology. More than 2500 scientists are involved in setting up and later exploiting the Modularised Start Version. It also provides a unique scientific and technological environment for educating the next generations of students and preparing them for careers in basic research and industry. In view of tough international competition, this is of great importance for all FAIR partners.

Modules 4 - 6 are scientifically highly desirable and obvious upgrades of the Modularised Start Version, further strengthening the long-term potential and scientific viability of FAIR.

The international FAIR Convention was signed on 4/10/10 and the FAIR GmbH established on the same day.

#### **SPIRAL2 at GANIL, Caen, France**

SPIRAL2 is a new European facility to be built at GANIL laboratory in Caen, France. The project aims at delivering stable and rare isotope beams with intensities not yet available with present machines. SPIRAL2 together with FAIR will reinforce the European leadership in the field of nuclear physics based on exotic nuclei and as such was selected for the ESFRI road-map.

**The facility:** The driver of the SPIRAL2 facility is a high power, CW, superconducting LINAC, delivering up to 5 mA of deuterons at 40 MeV (200 kW, the highest power ever delivered by this type of accelerator) directed on a Carbon converter + Uranium target. Production of the radioactive nuclear beams is based essentially on the fast neutron induced fission of the uranium target. The expected radioactive ion beams intensities in the mass range between  $A=60$  and  $A=140$ , reaching up to  $10^{10}$  particles per second for some species, will be unique in the world. These unstable beams will be available at energies ranging between a few keV/nucleon at the DESIR facility up to 20 MeV/nucleon (up to 9 MeV/nucleon for fission fragments) at the existing GANIL experimental areas, which will be enriched by a large number of next generation detectors such as AGATA, PARIS and EXOGAM2  $\gamma$  arrays, GASPARD, HELIOS and FAZIA charged particle detectors/arrays, NEDA neutron detector or the ACTAR active target.

The SPIRAL2 LINAC will accelerate also high intensity (up to 1 mA) heavy ions up to 14.5 MeV/nucleon. They will be used to enlarge the range of exotic nuclei produced by the ISOL method towards neutron-deficient nuclei or very heavy nuclei produced by fusion evaporation, or towards light neutron rich nuclei via transfer reactions. The heavy-ion beams will also be used to produce in-flight a large palette of neutron deficient and very heavy exotic nuclei with the Super Separator Spectrometer (S3). The high neutron flux produced with the deuteron beam at the Neutron For Science facility (NFS) will open up a broad new field of research at GANIL with new experimental possibilities for applications and reliable nuclear data evaluation.

**Scientific goals:** The main goal of SPIRAL2 is to extend the knowledge of the limit of existence and of the structure of nuclei towards presently unexplored regions of the nuclear chart, in particular in the medium and heavy mass regions. The scientific programme proposes the investigation of the most challenging nuclear and astrophysics questions aiming at a deeper understanding of the nature of matter. It also addresses many different types of applications of nuclear physics of interest to the society, such as nuclear energy and medicine, radiobiology and materials science. This scientific programme, elaborated by a team of six hundred specialists from all over the world, will contribute to the physics of nuclei far from stability, nuclear fission and fusion based on the collection of unprecedented high precision detailed basic nuclear data, to the production of rare radioisotopes for medicine, to radiobiology and to materials science. The SPIRAL2 project is also an intermediate step and essential towards the building of EURISOL, the most advanced nuclear physics research facility presently imaginable in the world (based on the ISOL principle).

**New legal status:** The current discussions with international partner countries would allow them to join the ongoing construction of the base-line project and associated detectors as well as the future operation phase, turning the present GANIL into a fully international legal entity. Up to now 15 MoUs, European associated Laboratories (LEA) and International Associated Laboratories (LIA) agreements have been signed with major laboratories, institutions and ministries worldwide (Japan, China, India, US, EU...). The transformation of GANIL with SPIRAL2 into a fully international facility is also the main goal of the ongoing EU FP7 SPIRAL2 Preparatory Phase contract (25 partners from 13 countries, EU contribution of 3,9M€).

**Timeline and status:** The construction of SPIRAL2 is expected to last about 7 years (2006-2014) and is separated into two phases:

1. Linear accelerator with S3 and NFS experimental halls - commissioning expected in 2012.

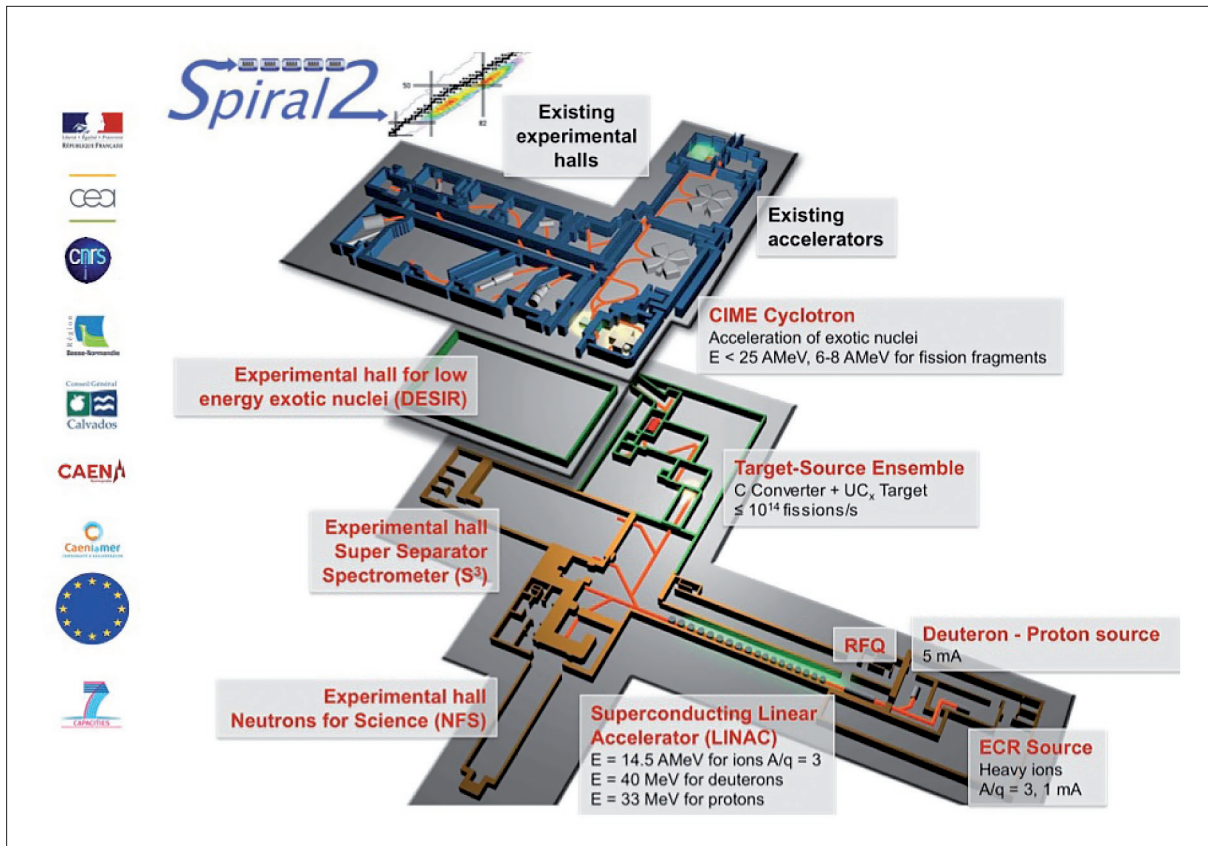

SPIRAL2 nuclear facility at GANIL in Caen, France.

2. Radioactive Ion Beam production hall and DESIR low-energy RIB facility – commissioning expected in 2014.

All essential sub-systems of LINAC are in their final stages and many of them, in particular the super-conducting cavities, were already delivered and successfully tested. The civil construction of the facility is expected to begin in the second half of 2010.

A detailed design study of the second phase, namely the RIB production building, the DESIR hall and associated instrumentation are in an advanced stage and are expected to be ready by 2011.

**Estimated costs:**

- Project preparation cost: 6.6 M€.
- Total construction cost: 196 M€.
- Operations cost: ~6.6 M€/year.

The project is co-funded by CEA/DSM, CNRS/IN2P3, local authorities in Normandy, EC and international partners.

**Further extensions:** A straightforward extension of the facility, namely a second heavy-ion injector for LINAC accelerating heavy ions with A/q ratio equal to 6, will allow an increase in the intensity of medium-mass and heavy beams.

In the mid-term future, a secondary fragmentation of the SPIRAL2 rare isotope beams accelerated to energies greater than 150 MeV/nucleon would be a natural progression of the facility towards EURISOL.

The GANIL/SPIRAL2 facility will open up a new avenue for RIB physics in Europe. With its rich and multipurpose scientific programme, the SPIRAL2 project is not only a great promise for the nuclear physics community; it will also substantially increase the expertise in developing novel technical solutions to be applied not only for EURISOL, but also for a number of other European/world projects.



## 3. Research Infrastructures and Networking

### 3.2.2 Planned ESFRI Facilities

There are two large multi-purpose facilities that are being requested to be put on the ESFRI list in the near future, MYRRHA and ELI, both of which will be of interest to the European Nuclear Physics community.

#### MYRRHA, Mol, Belgium

From 1998 on, SCK•CEN has been studying the coupling of a proton accelerator, a liquid Lead-Bismuth Eutectic (LBE) spallation target and a LBE cooled, sub-critical fast core. The project, called MYRRHA, aims at constructing an Accelerator Driven System (ADS) at the SCK•CEN site in Mol (Belgium).

Presently, MYRRHA is conceived as a flexible fast spectrum irradiation facility, able to operate in an ADS subcritical mode or as a critical reactor. MYRRHA will allow nuclear fuel research and development for innovative reactors, structural materials development for GEN IV and fusion reactors, medical radioisotope production and industrial applications such as Si-doping.

MYRRHA will also demonstrate the full ADS concept by coupling three components (accelerator, spallation target and subcritical reactor), and this at a reasonable power level to allow operation feedback that is scalable to an industrial demonstrator for the study of efficient transmutation of high-level nuclear waste. The nominal core power of MYRRHA will be 57 MW(thermal).

The MYRRHA proton accelerator (proton energy of 600 MeV and a maximum beam intensity of 4 mA continuous wave on target) on its own can be used to supply proton beams for a number of experiments. In order to explore new research opportunities offered by the accelerator, a pre-study was initiated within the framework of the “Belgian Research Initiative on eXotic nuclei” (BriX) network of the Interuniversity Attraction Poles Programme of the Belgian State. This study is investigating unique possibilities for fundamental research using high-intensity

proton beams with a fraction of the full beam during ADS operation (up to 200  $\mu$ A) of MYRRHA.

An interesting approach for fundamental research using the 600 MeV proton accelerator is the installation of an Isotope Separator On-Line facility (called *ISOL@MYRRHA*) with a ruggedized target-ion source system, which is able to provide intense low-energy Radioactive Ion Beams (RIBs) for experiments requiring very long beam times (up to several months). This will open up unique opportunities for RIB research in various scientific fields, ranging from fundamental-interaction measurements with extremely high precision over systematic measurements for condensed-matter physics and production of radioisotopes. Experiments, requiring very high statistics, needing many time-consuming systematic measurements, hunting for very rare events, or having inherent limited detection efficiency, have a particular interest in the use of extended beam time. This makes *ISOL@MYRRHA* complementary with the activities at other existing and future facilities. During the main shut-down maintenance periods of the MYRRHA reactor (3 months every 11 months), the full proton beam intensity can be used for *ISOL@MYRRHA* or other applications.

In March 2010, the Belgian federal government has committed itself to financing 40% of the total investment for MYRRHA. The remainder needs to be financed by an international consortium that has to be set up in the coming years. MYRRHA is foreseen to be operational by 2024.

#### ELI, Bucharest, Romania.

The Nuclear Physics, ELI-NP, facility is one of the pillars of the Extreme Light Infrastructure, ELI, the proposed European Research Infrastructure devoted to high-level research on ultra-short high-power lasers, laser-matter interaction and secondary radiation sources with unparalleled possibilities. ELI-NP will be built in Magurele near Bucharest (Romania). Two other pillars, ELI-Attoseconds and ELI-Beamlines, will be built in Szeged (Hungary) and respectively in Prague (Czech Republic). The unified operations of the pillars will be assured by ELI-ERIC to be established before 2015 when the construction phase of the first three pillars will be completed.

ELI-NP will consist in two major parts:

- A very high intensity laser system, where two 10 PW lasers are coherently added to the high intensity of  $10^{23}$ - $10^{24}$  W/cm<sup>2</sup> or electrical fields of  $10^{15}$  V/m.
- A very intense ( $10^{13}$   $\gamma$ /s), brilliant  $\gamma$  beam, 0.1 % bandwidth, with  $E_{\gamma} = 19$  MeV, which is obtained by incoherent Compton back scattering of a laser light off a very brilliant, intense, classical electron beam

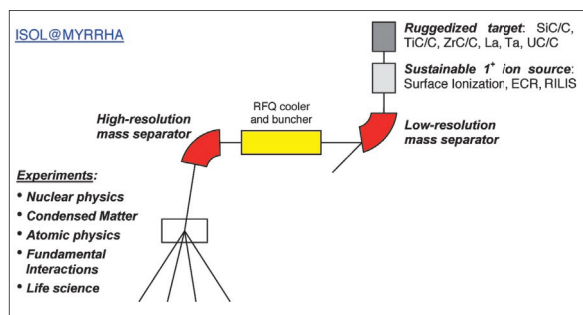

Layout of the ISOL@MYRRHA radioactive beam set-up at MYRRHA in Mol, Belgium.



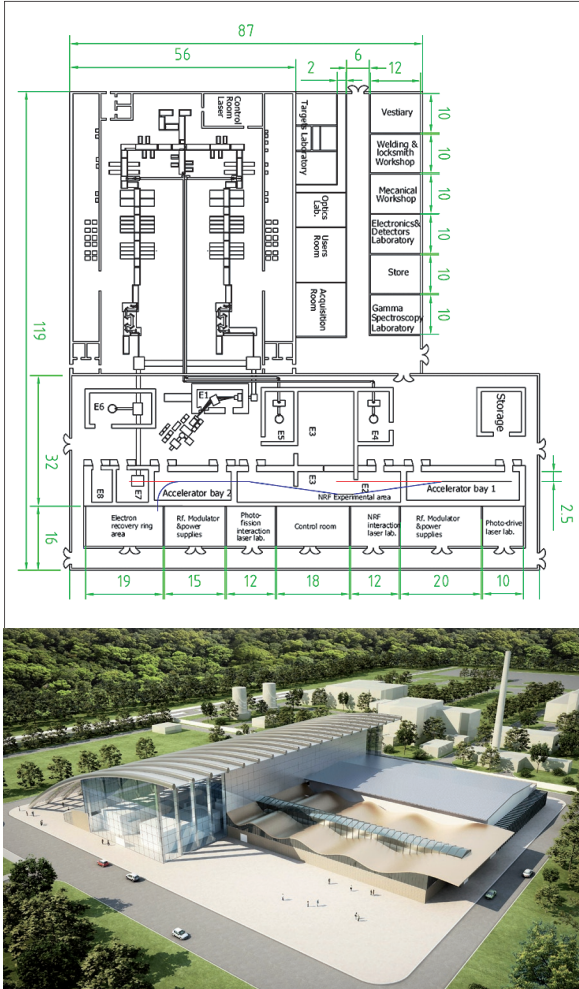

Layout and architectural view of ELI-NP facility.

( $E_e = 600$  MeV). The brilliant bunched electron beam will be produced by a warm linac using the X-band technology.

Compared to former  $\gamma$  facilities, the much improved bandwidth is decisive for this new  $\gamma$  beam facility. The  $\gamma$  beam will have unique properties in worldwide comparison and opens new possibilities for high-resolution spectroscopy at higher nuclear excitation energies. Several experiments, like a parity violation experiment, only become possible due to this much better bandwidth. They will lead to a better understanding of nuclear structure at higher excitation energies with many doorway states, their damping widths, and chaotic behaviour, but also new fluctuation properties in the time and energy domain. The detailed investigation of the pygmy dipole resonance above and below the particle threshold is very essential for nucleosynthesis in astrophysics.

The use of the very high intensity laser and the very brilliant, intense  $\gamma$ -beam will achieve major progress in nuclear physics and its associated fields like the element synthesis in astrophysics and many new applications. In ion acceleration, the high power laser allows to produce  $10^{15}$  times denser ion beams than achievable with classical acceleration. The cascaded fission-fusion reaction mechanism can then be used to produce very neutron-rich heavy nuclei for the first time. These nuclei allow to investigate the  $N = 126$  waiting point of the r-process in nucleosynthesis. Thus, with this type of new laser acceleration mechanism, very significant contributions to one of the fundamental problems of astrophysics, the production of the heavy elements beyond iron in the universe can be addressed. Moreover, interesting synergies are achievable with the  $\gamma$ -beam and the brilliant high-energy electron beam to study new fundamental processes in high-field QED.

In addition to a wide range of fundamental physics projects, applied research will also be performed at ELI-NP. The  $\gamma$ -beam can be used to map the isotope distributions of nuclear materials or radioactive waste remotely via Nuclear Resonance Fluorescence (NRF). New schemes for the production of medical isotopes via  $(\gamma, n)$  reactions will be of high socio-economical relevance. Low energy, brilliant, intense neutron beams and low energy, brilliant, intense positron beams will be produced that open up new fields in materials science and the life sciences.

### 3.2.3 Major Upgrades of Existing Facilities

Major upgrades of existing European nuclear facilities have recently been approved to take place at CERN, INFN-LNL Legnaro and GSI Darmstadt.

#### HIE-ISOLDE at CERN, Geneva, Switzerland

ISOLDE at CERN produces radioactive beams through fission, spallation and fragmentation reactions induced by 1.4 GeV protons from the PS booster. It offers the largest variety of post-accelerated radioactive beams in the world today. In order to broaden the scientific opportunities far beyond the reach of the present facility, the HIE-ISOLDE (High Intensity & Energy) project will provide major improvements in energy range, beam intensity and beam quality. A major element of the project will be an increase of the final energy of the post-accelerated beams to 10A MeV throughout the periodic table. This will be achieved by replacing the current REX LINAC by superconducting cavities and will be implemented in a

### 3. Research Infrastructures and Networking

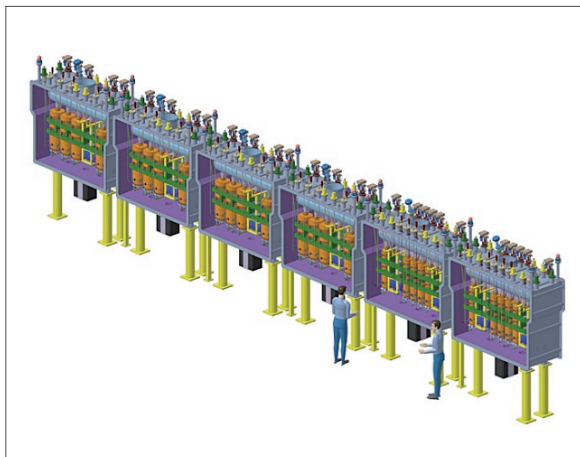

View of the HIE-ISOLDE LINAC.

staged fashion. The first stage will boost the energy to 6A MeV where the Coulomb excitation cross sections are strongly increased with respect to the current 3A MeV and many transfer reaction channels will be opened. In the second stage, additional cryo-modules will be added to bring the energy up to 10A MeV for all nuclides with  $A/Q = 4.5$  and up to 14A MeV for  $A/Q = 3$ . This will offer ideal conditions for transfer reactions over the whole periodic table, particularly the heavy elements uniquely produced at ISOLDE. Moreover, the provision of low beta superconducting cavities allows for CW operation and the delivery of beams with energies down to 0.5A MeV for astrophysics oriented measurements. The prototyping of these sputtered cavities is already ongoing.

In addition, the new CERN injector LINAC 4 will provide a major boost of the proton intensity onto the ISOLDE target. In the framework of HIE-ISOLDE, the target areas and ion sources are also being respectively upgraded and optimised in order to make use of the more intense proton beams from LINAC4 and to improve the efficiency for ion extraction and charge breeding. This will enable up to an order of magnitude more RIB intensity to be delivered for many nuclides. Improved beam quality will arise from several technological advances: the already implemented solid state lasers equipping the RILIS ion source and use of the recently commissioned RFQ cooler ISCOOL together with the construction of a new high resolution mass separator. The possibility of providing polarised beams will also be investigated.

The CERN Research Board has approved the project HIE-ISOLDE, on account of its scientific potential as well as its several unique features for ISOL radioactive beam production. At the horizon of 2014, the community may plan for experiments with the very large variety of beams available today with increased energy and inten-

sity. Along with SPIRAL2 at GANIL, France and SPES at INFN-LNL, Italy, HIE-ISOLDE will be a member of the European network of advanced ISOL radioactive beam facilities paving the way for the ultimate European ISOL facility EURISOL.

#### SPES at INFN-LNL, Legnaro, Italy

SPES is a new mid-term ISOL facility dedicated to the production of neutron-rich beams. It is an INFN project involving the two national laboratories, LNL and LNS and additionally other INFN sites in Italy. The project consists of a proton driver, a 70 MeV cyclotron with two exit ports for a total current of  $750 \mu\text{A}$ , an  $\text{UC}_x$  ISOL target and ion source, a beam transport system with high resolution mass selection and the superconductive PIAVE-ALPI accelerator complex in operation at LNL, which will be used as radioactive beam re-accelerator.

A proton beam of 40 MeV and  $200 \mu\text{A}$ , delivered by the cyclotron, will impinge on an uranium carbide target and neutron rich isotopes will be produced as fission fragments with a rate of  $10^{13}$  fission/s. The uranium carbide targets have already been developed and represent a technical innovation in terms of their capability to sustain the primary beam power. The neutron rich products will be extracted and mass separated to be re-accelerated. In particular, the radioactive ions, extracted in a  $1^+$  state using different ion sources depending on the kind of isotope, will be transported to the linear accelerator ALPI. This part of the SPES project will benefit from the experience gained in LNS (Catania) with the EXCYT project, which will be taken as a reference for the optimisation of the various magnetic and diagnostic elements. To fit the proper entrance parameters for beam re-acceleration with the linac, an RFQ-cooler and a charge breeder are planned to be installed. The design and construction of the charge breeder will be done in collaboration with SPIRAL2.

The re-acceleration stage with the superconductive linac ALPI will produce high-quality beams with regard to intensity and energy spread. the final energy interval

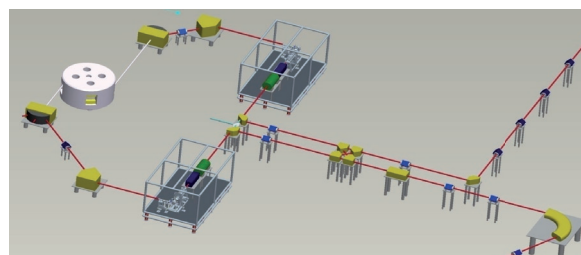

View of the proton cyclotron driver of the SPES radioactive beam facility at INFN-LNL in Legnaro, Italy

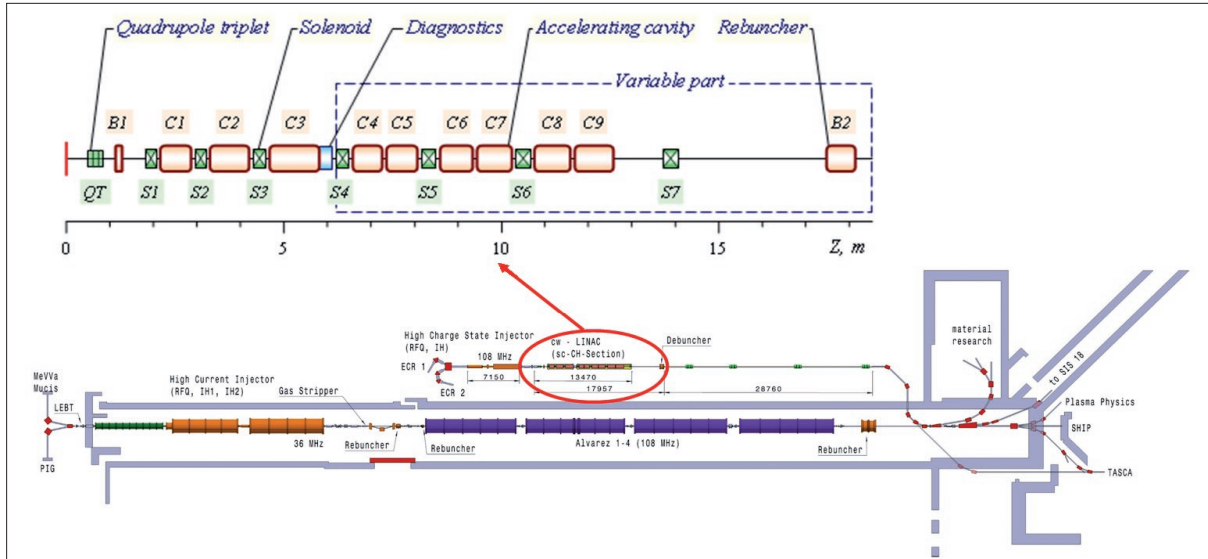

Layout of the cw-LINAC to be built in parallel to the existing UNILAC (Ci = Cavity, Bi = (Re-)Buncher, Si = Solenoid, QT = Quadrupole-Triplet).

(5-15 MeV/nucleon) is ideal for investigations of nuclear reactions between medium-heavy nuclei close to the Coulomb barrier. With the high intensity beams delivered by SPES, a challenging and broader range of studies in nuclear spectroscopy and reaction mechanisms will be performed. Interesting areas where new data will be obtained are those concerning nuclear properties in the very neutron rich regions, where shell evolution is an issue, requiring an extensive experimental programme. The question of how the pairing interaction is modified in the nuclear medium will be tackled by measurements of nucleon transfer reactions to specific nuclear states. Isospin effects in the collective rotation up to excitations in the order-chaos transition region and in  $\gamma$ -ray production due to dynamical dipole emission will be studied by varying the projectile  $N/Z$  ratio up to extreme values. Sub-barrier fusion with neutron rich ions will be studied to investigate the tunneling mechanism in the presence of very positive  $Q$ -values, an issue interesting also for astrophysics.

The SPES project also has a part devoted to other research and applications in conjunction with the possibility to use a second exit port at the cyclotron. In particular, the high intensity proton beam could be used to produce neutrons in a wide energy range, which would be very valuable for measurements of neutron capture reactions of astrophysical interest. Plans to use neutrons for applications in the fields of chemistry, radiobiology, material science and energetics are presently in the discussion phase.

### Superconducting Linac at GSI, Darmstadt, Germany

GSI applied for a new superconducting (sc) cw-LINAC to be set up in parallel to the existing UNILAC (Universal Linear Accelerator). Such a machine is highly desirable with respect to the needs in the field of Superheavy Elements (SHE) for example. The GSI UNILAC is limited in providing a proper beam for SHE and in fulfilling the requirements for FAIR (Facility for Antiproton and Ion Research) simultaneously.

A sc Crossbar-H (CH) structure is the key component of the proposed compact LINAC. In first vertical rf-tests at the Institute of Applied Physics (IAP) in Frankfurt maximum gradients of up to 7 MV/m were achieved. The cw-LINAC should be operated at 217 MHz with cavities providing gradients of 5.1 MV/m over a length of minimum 0.6 m.

In a first step, a prototype of such a sc cw-LINAC as a demonstrator is financed by the Helmholtz Institute Mainz (HIM). The demonstrator is the first section of the proposed cw-LINAC comprising a sc CH-cavity embedded between two sc solenoids. The aim is a full performance test of the demonstrator with beam at the GSI high charge injector (HLI) in 2013. Presently tendering for the solenoids, the cavity, the cryostat and the rf-amplifier is in progress.



## 3. Research Infrastructures and Networking

### 3.2.4 Travelling Detectors

Large (and heavy) detector set-ups such as magnetic spectrometers can only be used at one facility. Smaller, but still very expensive, particle, and specifically  $\gamma$ -ray, detectors may be moved from one laboratory to another taking advantage of unique features of their respective accelerator/experimental equipment. Often  $\gamma$ -ray crystal balls such as AGATA have been travelling all around Europe.

#### AGATA

$\gamma$  spectroscopy is an essential tool to study nuclear structure and very rich experimental programmes employing this technique have been carried out using stable and radioactive beams.

It is well established that experiments using complex arrays based on Germanium detectors (such as EUROBALL, EXOGAM, MINIBALL and RISING) have delivered important scientific results and developed new technical methods. The expertise to construct the new AGATA array is built on the successful experience from these arrays and on the exciting possibilities to address new physics by investigating nuclei far from stability, which will be produced at the new or upgraded accelerator facilities.

Nuclear structure is a very expansive research topic and using  $\gamma$  spectroscopy one can investigate the different degrees of freedom characterising the nuclear many body system, and its underlying interactions. Using heavy ion reactions and radioactive beams, the structure of nuclei with numbers of protons and neutrons much different from those in the valley of stability can be investigated. Important steps to achieve this goal are expected with the construction of the European array AGATA, which is based on a novel  $\gamma$ -ray tracking technique and thus, when fully completed, is designed to be orders of magnitude more powerful than all current  $\gamma$ -ray spectrometers.

The modular design allows the array to be constructed in phases so that some modules can be used to carry out specific experimental campaigns at different laboratories. Agreement has been reached among various nuclear laboratories to exploit fully the capability of AGATA in searching for new physical effects when nuclear structure is investigated at extreme conditions of isospin, spin and temperature.

The AGATA demonstrator at LNL consists of a subset of 5 detector units with full tracking capability and is devoted to the study of nuclear properties far from stability, with nuclei identified by the PRISMA magnetic spectrometer. The programme is well connected to

the future experimental campaigns aiming at studying nuclei further away from the stability line. In fact, the next experimental campaign at GSI will use the secondary beams from the Fragment Recoil Separator and in this connection the previous experiments with RISING are very valuable. After that, AGATA is planned to be mounted at SPIRAL or SPIRAL2. For the future physics programmes at SPIRAL2, NUSTAR at FAIR, and SPES at LNL, AGATA will be used extensively. The coordination of the different experimental campaigns using AGATA at various laboratories is supported via a specific networking activity within ENSAR in FP7.

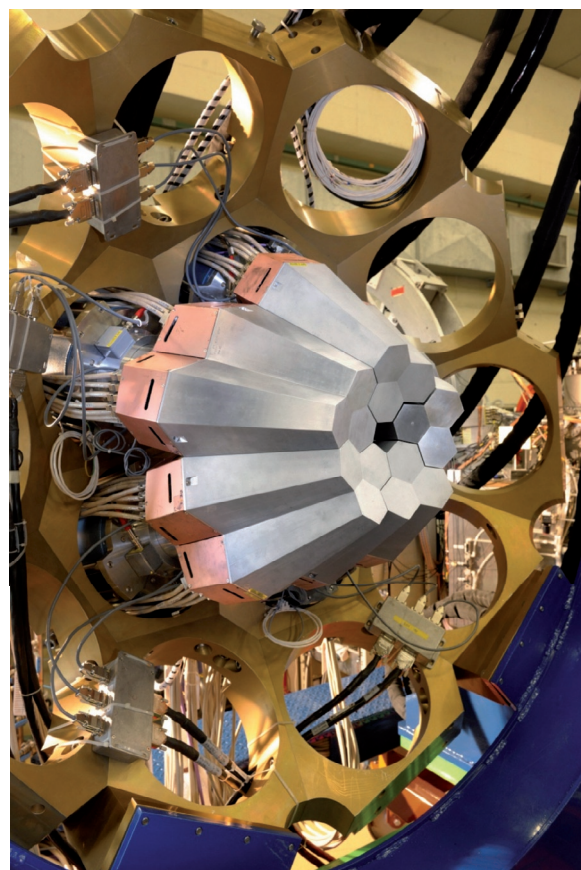

The AGATA demonstrator mounted at INFN-LNL in Legnaro, Italy.



### 3.2.5 Projects & Design Studies

Since the lead times for building large-scale Nuclear Physics research infrastructures can be very long, one needs to start planning in good time. Four projects are being pursued currently, the radioactive beam ISOL facility EURISOL, two projects that would upgrade FAIR, the polarised antiproton – polarised proton collider, PAX, and the polarised Electron – polarised Nucleon Collider, ENC, both to be set up at FAIR’s High Energy Storage Ring, HESR, and finally the high-energy Electron-Ion Collider, LHeC, at CERN as a potential upgrade to the LHC.

#### EURISOL

The EURISOL concept was born 10 years ago, as the “ultimate” ISOL facility for Europe. A conceptual design study was carried out as the EURISOL Research & Technology Development project within the European fifth framework programme and subsequently a technical Design Study was undertaken in the sixth framework. The EURISOL DS provided a credible design for the facility. It resulted from an investment of close to 30 million Euros and has been validated by international expert panels.

Prototypes of some essential components of EURISOL such as superconducting LINAC cavities and the Hg converter target loop were constructed and tested.

EURISOL will consist of a Superconducting CW LINAC capable of accelerating 5 mA of  $H^-$  to 1 GeV (5 MW beam power) with additional capability for  $d$ ,  $^3He$  and heavy ions with  $A/Q = 2$ . The major part of the beam will be sent to a Hg loop converter where the neutrons produced will induce fission in six UCx targets surrounding the converter. The flux from the six targets will be merged in a novel ARC-ECRIS ion source. An innovative magnetic beam splitting system will create up to three additional 100 kW beams that will impinge directly on solid targets to induce spallation reactions which can populate the regions of the nuclear chart unattainable in fission reactions. After selection, the radioactive beams can either be used at low energies or post-accelerated in another superconducting LINAC with continuous energy variation up to 150 MeV for  $^{132}Sn$  for example. Multi-user capability is an essential ingredient of the concept. The high energy n-rich beams such as  $^{132}Sn$ , which will reach intensities of up to  $10^{12}$  pps can then be fragmented to produce with large intensities many

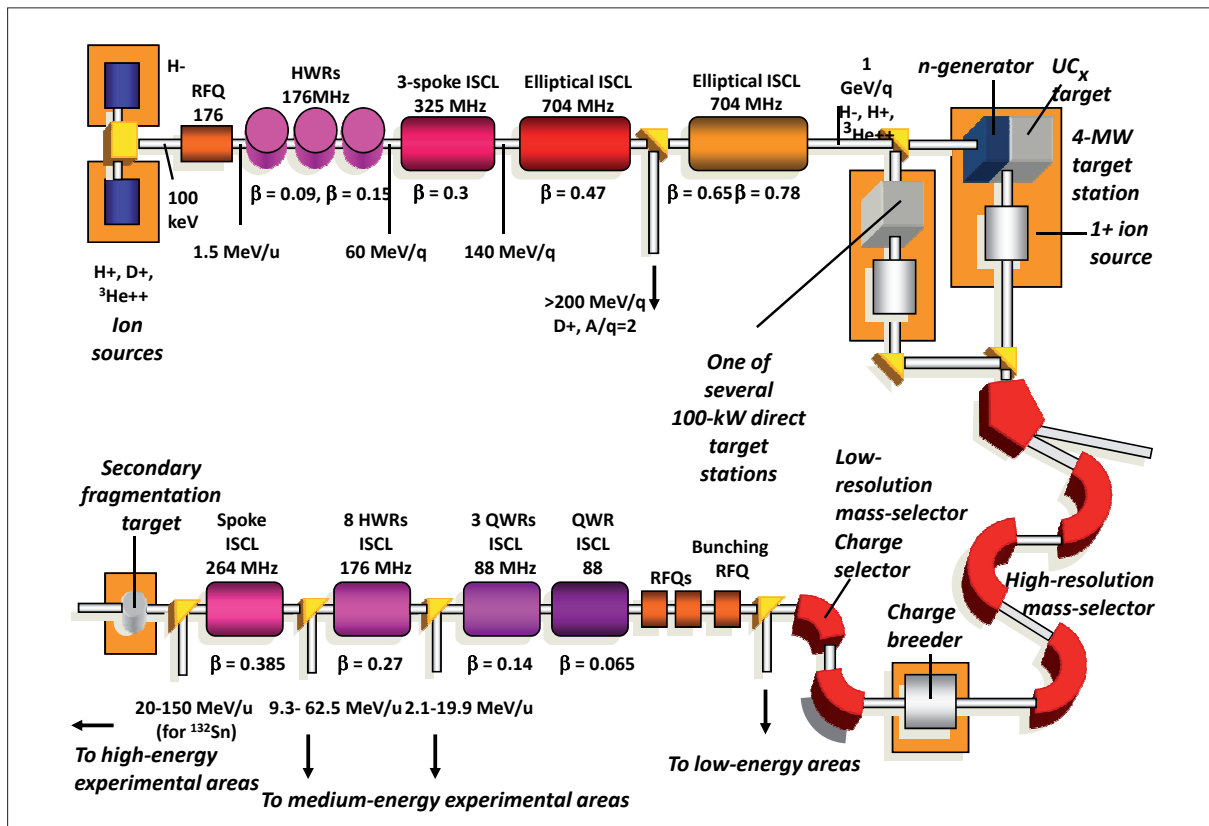

Block diagram of the EURISOL facility.

### 3. Research Infrastructures and Networking

n-rich nuclei otherwise inaccessible. A block diagram of the future EURISOL facility is shown below.

EURISOL will open up new vistas for radioactive beam research. Nuclear structure at and beyond the drip-lines, the detailed study of new types of radioactivity, the isospin dependence of nuclear phase transitions, the mapping of the r-process path, the physics of neutron stars and precision tests of the standard model are just a few of the subjects for which EURISOL will bring decisive advances. The Nuclear Physics community has endorsed EURISOL as one of the major facilities capable of sustaining the long-term future of the field.

The next stage of the EURISOL road map includes the construction and exploitation of the network of facilities comprising HIE-ISOLDE, SPES and SPIRAL2. It is vital that all three of these installations, which will bring major advances to radioactive beam science as well as demonstrate many of the technical solutions for EURISOL, receive adequate support to ensure their timely completion. Opportunities to upgrade these facilities; for example by replacing the SPIRAL2 post accelerator at GANIL by a powerful LINAC or promoting a high intensity solution for the replacement of the CERN injector chain should be investigated and pursued. Such developments would position CERN and GANIL as frontrunners in the competition to host the facility for which they were identified during the DS as favourable sites along with LNL Legnaro and Rutherford Laboratory in the UK. Simultaneously, it is necessary in the next few years to continue to fund a specific R&D programme for a few of the main technical challenges for EURISOL. Beam tests of a Hg loop converter, prototyping of an ARC-Ecris source and of a magnetic beam splitting system have been identified as being on the critical path towards the realisation of the facility. Maintaining a Project Office is important to ensure a continuous and coherent effort. EURISOL is the Nuclear Physics community's priority for accession to the ESFRI list, at the time of its next update scheduled in 2012.

#### ENC at FAIR, Darmstadt, Germany

The main problem of hadron physics is to understand the nucleon in terms of elementary degrees of freedom – quarks and gluons – and their underlying non-abelian gauge theory of QCD. This problem is of utmost importance to the whole of contemporary physics, since on the one hand it paves the road to an *ab initio* understanding of even more complex strongly interacting systems such as nuclei, while on the other hand, it pushes forward the precision frontier in high-energy physics, where analyses in many cases are limited by the hadron physics input. Lepton/Nucleon colliders are considered as a decisive tool for future hadron structure physics experiments.

Such machines have to provide polarised beams of both particle species, with high luminosity at centre of mass energies that match or exceed those of fixed target installations like JLab or HERMES.

The challenge of understanding the structure of ground and excited state hadrons can be expressed as the need of predicting hadronic properties and processes with good and controlled precision. The interaction of a polarised beam of charged leptons with a beam of polarised protons and deuterons is dominated by photon exchange at momentum transfer values well below the mass of the W intermediate boson  $M_W^2$ .

The scientific goals of the ENC comprise the precise determination of the spin flavour structure of the nucleon consisting of quarks and gluons. The quark structure is

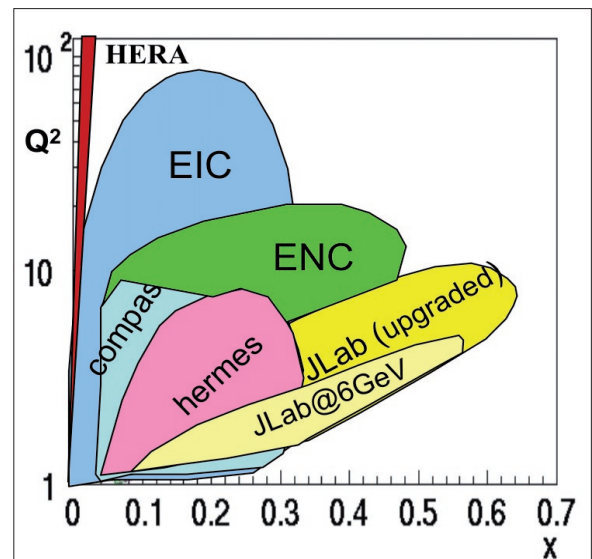

Kinematical acceptance of the ENC as compared to other experiments.

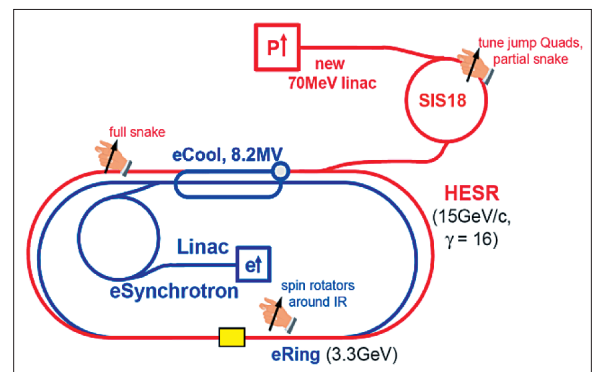

Layout of ENC@FAIR.

---

parameterised in structure functions  $f$ ,  $g$  and  $h$ , where  $f$  refers to unpolarised quark distributions,  $g$  to longitudinally polarised quarks and  $h$  to transverse polarisation. In addition, the new generalised parton distributions (GPDs), which are measured in exclusive reactions, allow at the same time a correlated tomography of the nucleon in the impact parameter plane as they have a direct connection to the question of the angular momentum of the quarks in the nucleon. The gluon spin contribution has been confined by recent results from COMPASS and HERMES to be small, but remains not understood due to the large experimental errors. In addition, transverse momentum dependent structure functions, measured in semi inclusive scattering, give connections to angular momentum of quarks as well as transverse polarisation in the nucleon.

Besides these main topics, the process of helicity dependent fragmentation is needed for the interpretation of deep inelastic scattering. All recent theory developments described above are based on factorisation theorems. Any experimental study on these structure functions requires first a large enough value of  $Q^2$  and, in addition, a large lever arm in  $Q^2$  to show that factorisation holds. This can naturally be achieved at a collider.

The electromagnetic probe yields the required precision, but requires high luminosity. In addition, the collider kinematics allow a complete reconstruction of the final state, which is difficult for a fixed target experiment and of utmost importance for the detection of exclusive scattering processes.

The quest for the realisation of a high luminosity electron nucleon collider with a centre-of-mass energy  $s^{1/2}$  above 10 GeV has been made substantially easier by the FAIR project. The HESR tunnel of the antiproton complex with the PANDA experiment has been designed to store antiprotons up to a momentum of 15 GeV/c.

We propose to extend the HESR storage ring facility – presently under construction at FAIR – by an additional electron ring. The project is called **Electron Nucleon Collider at FAIR (ENC@FAIR)**. It yields an opportunity to create a doubly polarised collider on a comparatively short timescale with very reasonable investment.

The figure above shows the acceptance of such a collider project. It demonstrates the substantial extension of the kinematical range to ensure a sufficiently large lever arm in  $Q^2$  for factorisation to hold.

Extensive physics simulations are in progress to explore the response of the PANDA detector, which has been designed for fixed target mode, for the collider case. One expects for doubly polarised channels a gain in the figure of merit of a factor 20 – 100 as compared to fixed target experiments. This arises partly from the

missing fixed target dilution factors, but also from higher efficiencies for the detection of final states in collider mode, e.g. for the detection of D-mesons.

The accelerator physics aspects of ENC@FAIR are presently studied by a working group consisting of accelerator physicists from German universities (Mainz, Bonn, Dortmund) and several research centers (GSI, FZJ, DESY and BNL).

The HESR storage ring will provide ion beams with a maximum momentum of 15 GeV/c. A 3.3 GeV electron ring will be integrated into the HESR tunnel, yielding a c.m. energy of  $s^{1/2}=13.5$  GeV in head on collisions with protons.

The production and acceleration of polarised electrons has been a standard feature at many electron accelerator facilities. A sufficient electron polarisation lifetime in the collider mode can be achieved by careful arrangement of the electron ring lattice. Peak currents will be in the region of 25 Amps, which does not exceed the limits explored by existing storage rings.

The production and transport of polarised protons or deuterons through the FAIR injector chain is also feasible, and so is the spin stable operation of the HESR, since its cooler solenoid can be operated as a full Siberian snake with only moderate additional effort. We therefore believe that sufficiently stable beams, with high polarisation ( $P_e=P_{ion}\sim 0.8$ ) and arbitrary direction of the spin in the interaction region are achievable in proton operation.

The use of the PANDA detector (which is foreseen for fixed target antiproton experiments at HESR) is an attractive and especially cost-effective solution, since many of its components can also be utilised in collider mode. A design for the interaction region has already been achieved. It is compliant with the needs of efficient particle detection and stable collider operation. This ‘conservative’ design is limited to luminosities of  $1.1 \times 10^{32}$ . A more aggressive approach, which requires advanced – but already demonstrated – techniques like crab crossing, is under investigation. An increase of the bunch number to 200 (collision rate 104 MHz) could then allow for a luminosity of  $>4 \times 10^{32}$ .

ENC@FAIR has to make use of the electron cooler at HESR (foreseen for antiproton cooling in PANDA high luminosity mode) in order to conserve transverse and longitudinal emittance during collider operation and to achieve sufficiently small emittance during acceleration. Therefore, for proton operation, the HESR cooler must be upgraded to 8.2 MeV at d.c. currents of several amps. The simultaneous achievement of these cooler parameters has not been demonstrated yet, but does not seem unrealistic.

### 3. Research Infrastructures and Networking

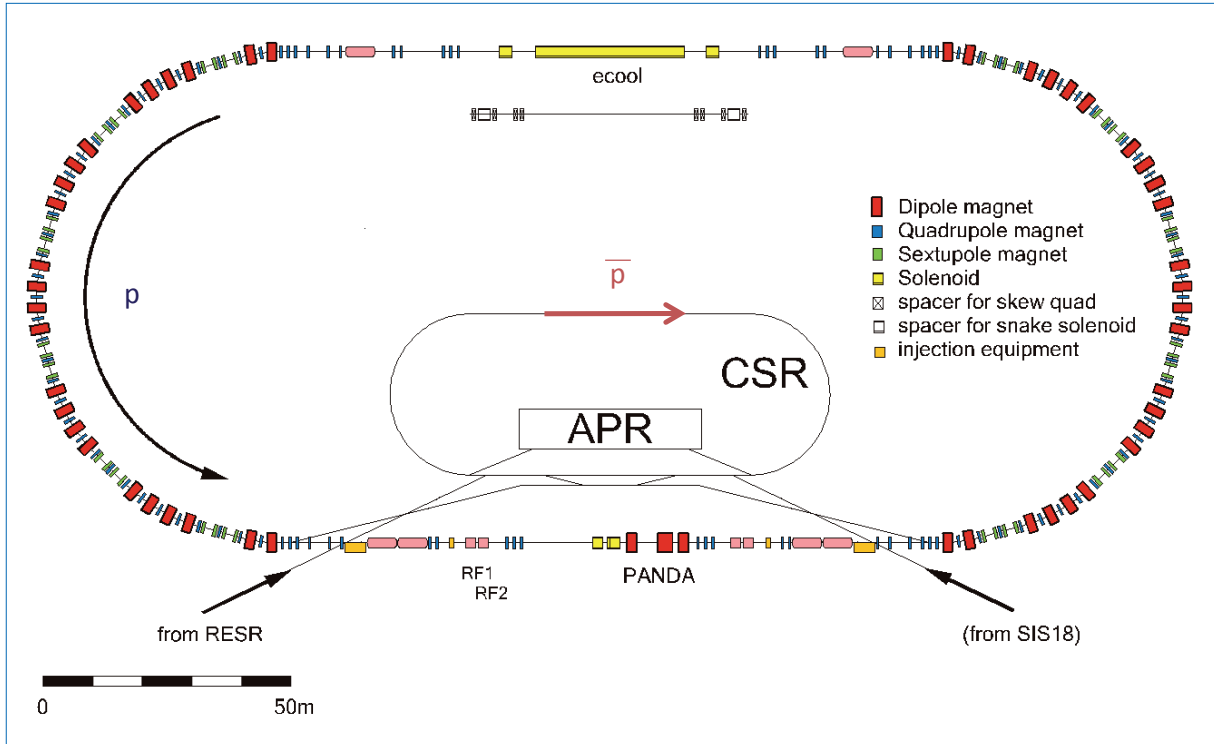

Proposed accelerator layout to convert the HESR into a double-polarised proton-antiproton collider. Polarised antiprotons are produced in the Antiproton Polariser Ring (APR) and then injected in the (COSY-like) Cooler Synchrotron Ring (CSR). Polarised protons will circulate in the HESR.

A dedicated r.f.-system must be incorporated into HESR to allow for multi bunch operation ( $h=100$ ) at collision energy. A bunch length  $s_L \leq 0.3\text{m}$  is foreseen to avoid luminosity reduction by the hourglass effect. Another extension of the HESR r.f.-system is required by the task of accumulating a sufficient number of polarised bunches at injection energy which leads to strong space charge forces at this stage.

#### PAX at FAIR

A new chapter in studies of hadron physics will unfold with the advent of a polarised antiproton beam provided an efficient method for polarising antiprotons can be demonstrated. The PAX Collaboration is performing dedicated experiments to investigate the feasibility of the only viable method demonstrated so far that could yield a beam of polarised antiprotons, which is spin-filtering of a stored beam by selective loss and selective spin-flip through repetitive interaction with a polarised internal target. Should this investigation be successful, a natural implementation of polarised antiprotons might be foreseen at the FAIR facility. The PAX Collaboration has suggested to convert HESR into an asymmetric

polarised proton – polarised antiproton collider and to study double polarised antiproton-proton reactions.

The physics case for experiments with polarised antiprotons comprises:

- Double polarised antiproton-proton Drell-Yan reactions, which are entirely dominated by the annihilation of valence quarks in the proton with the valence antiquarks in the antiproton. The measured double spin-asymmetry  $A_{TT}$  will allow the first direct measurement of the still undetermined leading order (twist 2) transversity structure function of the nucleon. No other existing or future facility will be ever able to measure the transversity in a competitive way directly.
- Measurements of the moduli and absolute phases of the electromagnetic form-factors in the time-like region, providing an independent way of testing the Rosenbluth separation in the time-like region;
- Measurements of double-polarised proton-antiproton hard scattering to be compared to the analogue pp measurement, the asymmetry of which represents the largest ever measured asymmetry in hadron physics, and for which a theoretical interpretation is still missing;



- Hadron spectroscopy studies and searches for exotic new states like glueballs or hybrids will benefit from polarisation of beam or target particles, because the initial spin state of the system can be prepared at will.

The overall machine layout of the HESR complex, schematically depicted in the figure above, consists of:

- An Antiproton Polariser (APR) built inside the HESR area with the crucial goal of polarising antiprotons at kinetic energies around 50 – 250 MeV, to be accelerated and injected into the other rings.
- A second Cooler Synchrotron Ring (CSR, COSY-like) in which antiprotons can be stored with a momentum up to 3.5 GeV/c.
- By deflecting a proton beam stored in the HESR with a momentum up to 15 GeV/c into the straight section of the CSR, a double polarised proton-antiproton collider becomes feasible with a maximum reachable center of mass energy of  $\sqrt{s}=\sqrt{200}$  GeV/c<sup>2</sup>.

Extensive Monte Carlo studies are being performed to investigate different options for the PAX detector configuration, aiming at an optimization of the achievable performance. The primary goal of the PAX experimental programme is to carry out a direct measurement of the transversity distribution. The proposed detector, as described in the PAX Technical Proposal is well suited to provide  $e^+e^-$  Drell-Yan pair detection. The Drell-Yan process is the reaction with the highest demand on luminosity among the ones proposed by PAX. A value of  $P_p > 0.80$  can be assumed for the proton beam polarisation, whereas values of  $P_{pbar}$  around 0.20 are anticipated for the antiproton beam polarisation. With a projected luminosity  $L = 1 \times 10^{31} \text{cm}^{-2}\text{s}^{-1}$  for the collider, a statistical error of about 0.015 can be achieved in one year of data taking. This uncertainty should be compared to the value of the measurable asymmetry, which is ten times higher (of the order of 0.15).

### LHeC at CERN, Geneva, Switzerland

The current status of the LHeC is that of a joint CERN-ECFA-NuPECC feasibility study, where a conceptual design report (CDR) is being worked out for delivery by the end of 2010. The CDR is devoted to the accelerator, the interaction region, and the detector, and to the main physics topics: high precision QCD and electroweak interactions, new physics beyond the standard model, and physics at high parton densities. After the evaluation of the CDR, a Technical Design Report (TDR) may follow. Operation of the LHeC, possibly synchronously to the LHC, may thus begin in 2020.

The LHeC represents an upgrade project for the LHC, in which ep and eA collisions are realised with a polarised

electron/positron beam at or above 1 TeV energy in the electron-quark centre of mass system. This would be almost four orders of magnitude larger in  $Q^2$  and  $1/x$  than what was achieved in former lepton-nucleon/ion scattering experiments. The LHeC may thus become the world's highest resolution microscope of proton and nuclear structure in making efficient use of the large investments in the LHC.

The CDR will present two versions of the electron beam: i) A ring accelerator, positioned on top of the LHC using new dipole magnets under design at BINP Novosibirsk, providing a maximum considered energy of about 70 GeV at luminosities of order  $10^{33} \text{cm}^{-2}\text{s}^{-1}$ , which is 100 times larger than HERA. ii) A linac, tangential to the LHC, which with ILC type cavities in pulsed mode may provide energies of up to 140 GeV at luminosities of about  $10^{32} \text{cm}^{-2}\text{s}^{-1}$ . With energy recovery techniques, this luminosity limit may be overcome by about an order of magnitude. The electron beam is foreseen to be coupled with various ion beams, D, Ca, Pb, which are part of the LHC programme already.

For the LHeC, a new detector is under design, its dimensions are determined by the high p/A beam energy and the requirement of large acceptance coverage close to the beam pipe in forward and backward directions. Its technology choices are based on high accuracy demands in terms of alignment, calibration and resolution requirements.

The physics programme of the LHeC specific to ions can briefly be summarised as follows: a) The extension of the knowledge of the nuclear parton distributions by four orders of magnitude in kinematic range; b) The exploration of QCD parton dynamics in semi-inclusive eA scattering as diffraction or vector meson production; c) The discovery of saturation phenomena in ep and eA from the tamed rise of the gluon density towards low x beyond the unitarity limit; d) The investigation of the initial state in heavy-ion collisions leading to the formation of the quark-gluon plasma state; e) Stringent tests of parton fragmentation and hadronisation inside nuclei. In eA mode, the LHeC is therefore not just the extension of the former deep inelastic scattering programme with nuclei but the ideal and necessary supplement and continuation of the AA (and pA) programme at the LHC.

## 3. Research Infrastructures and Networking

---

### 3.3 Collaboration at European and Global Level

Nuclear Physics is a field of science that is particularly well connected at both the European and global level.

#### 3.3.1 Collaboration in Europe

The key players in the field at European level are the European Strategy Forum on Research Infrastructures, ESFRI, the European Science Foundation, ESF, the European Commission, EC, and the European Physical Society, EPS. All of them have, of course, a remit that is much broader than just Nuclear Physics. Still, Nuclear Physics facilities featured prominently on, for example, ESFRI's most recent list of large-scale research infrastructures to be built in Europe.

#### European Science Foundation

NuPECC is one of the six Expert Boards and Committees of ESF, which provide, in collaboration with the five Standing Committees, scientific advice to ESF's 79 member organisations. These are research funding and performing organisations, and academies from nearly all European countries. NuPECC reports to ESF's Governing Council and Assembly and is a member of the informal ESF Chairs Committee, which is chaired by either the ESF CEO or President.

NuPECC is autonomous to a high degree (self-financed by its own member organisations), but collaborates closely with the Physical and Engineering Sciences Standing Committee, PESC. NuPECC frequently participates in "Member Organisations (MO) Fora"; the most recent ones were held on "Interdisciplinarity" and "Scientific Foresight for Joint Strategy Development". In addition, NuPECC is a member of the ESF Steering Committee of the EU Framework Programme (FP) 7 Support Action MERIL on research infrastructures, with representatives from ESF's member organisations, ESFRI and the EU Commission.

#### EU Framework Programme 7

##### Integrating Activities

The EU Framework Programme 7 (FP7) Integrating Activities (IAs) offer transnational access (TA) to Europe's leading Nuclear Physics research infrastructures, foster collaboration between a large number of research groups at universities and national laboratories via Networking Activities (NAs) and help develop, for example, new high-tech equipment via Joint Research Activities (JRAs).

##### *HadronPhysics2*

The FP7 Integrating Activity HadronPhysics2 "Study of Strongly Interacting Matter" builds upon the success of its predecessor Integrated Infrastructure Initiative (I3) HadronPhysics in FP6. HadronPhysics2 offers Transnational Access to four large experimental hadron physics facilities in Europe and one research infrastructure for nuclear theory, ECT\*. The IA is further structured in 8 Networking Activities plus the Management of the Consortium and 14 Joint Research Activities. Approximately 2 500 scientists (both experimentalists and theoreticians) and engineers from ca. 150 European research institutions participate in HadronPhysics2.

##### *Transnational Access*

The HadronPhysics2 project supports access to five forefront hadron physics research infrastructures in Europe: ECT\* in Trento, MAMI in Mainz, GSI in Darmstadt, COSY in Jülich and INFN-LNF in Frascati/Rome. These institutions are also major players in the IA's Collaboration Committee, supporting its networking and joint research activities. In fact, most of the project's NAs and JRAs have been promoted by several infrastructures and each infrastructure is involved in several activities. This fact alone is a distinct example of European integration, and shows a very high potential for structuring this research field in Europe on a permanent basis.

##### *Networking Activities*

The eight Networking Activities aim at coordinating the work of hundreds of scientists each, and their use of resources, by promoting meetings, workshops and the involvement of young researchers. Two of them are theoretical networks devoted to studies of non-perturbative QCD and relativistic heavy ion collisions. Three networks deal mainly with higher-energy experimental projects at CERN, DESY, GSI and FAIR, three with meson production and decay, low-energy antikaon-nucleon/nucleus interactions and hypernuclear physics.

##### *Joint Research Activities*

The 14 Joint Research Activities cover innovative technological aspects of hadron physics experiments and large-scale lattice QCD calculations. The "theoretical" JRA Lattice Quantum Chromodynamics has successfully developed a multi-teraflop computer. The other JRAs may be grouped into three categories, all of them essential parts of particle accelerator facilities, namely beams, targets, and complex detector set-ups. Three JRAs investigate how best to produce polarised anti-proton beams and (polarised) hydrogen and deuterium targets. Ten JRAs drive the development of novel radiation detection techniques to observe emitted particles as well as photons.

---

## **ENSAR**

The FP7 Integrating Activity on European Nuclear Science and Applications Research, ENSAR, builds on the rich experience and successes of the previous Integrated Infrastructure Initiative EURONS (EUROpean Nuclear Structure) in FP6. ENSAR is the integrating activity of those European nuclear scientists that perform research in three of the major subfields of nuclear physics: Nuclear Structure, Nuclear Astrophysics and Applications of Nuclear Science. It provides funding for Transnational Access to European facilities, for new developments within Joint research Activities and for Networking Activities, all with the common aim of enhancing the capabilities of the participating infrastructures.

### **Transnational Access**

The core aim of ENSAR is, similar to EURONS, to provide access to seven of the complementary world-class large-scale facilities: GANIL (F), GSI (D), jointly to INFN LNL and LNS (I), JYFL (FI), KVI (NL), CERN-ISOLDE (CH) and ALTO (F). These facilities provide stable and radioactive ion beams of excellent quality ranging in energy from tens of keV/u to a few GeV/u. The stable ion beams range from protons to uranium. Radioactive ion beams are produced using the two complementary methods of in-flight fragmentation (IFF) and isotope separation on line (ISOL), so that several hundred isotopes are available to the user. The different species of ion beams and energies allow addressing different aspects of nuclear structure, nuclear astrophysics and of multidisciplinary and application oriented research. These activities ensure a high-level of socioeconomic impact.

### **Networking Activities**

The six network activities of ENSAR have been set-up with specific actions to strengthen the communities' coherence regarding particular research topics, to pool resources and to provide instruction courses to users, to foster future cooperation towards achieving new projects (high-intensity stable beams and EURISOL). They promote foresight studies for new instrumentation and methods, stimulate complementarity, ensure a broad dissemination of results and stimulate multidisciplinary and application-oriented research at the research infrastructures.

### **Joint Research Activities**

To enhance access to these facilities, the community has defined seven JRAs dealing with novel and innovative technologies to improve the operation of the facilities. They are in general relevant to more than one facility and rely on the strong participation of the European university groups. These activities involve all facets of operation of an accelerator facility starting with the improvement of ECR ion sources to increase the beam intensity and energy and of ISOL target technology. These activities

are supplemented by an activity to improve the low-energy beam preparation and manipulation of radioactive ion beams (RIBs). Experimenting at Nuclear Physics facilities requires development of new detection materials and detection systems, general platforms for both simulations of current and future detector set-ups and the development of modern theoretical tools for describing and interpreting experimental results. These aspects are tackled by three specific JRAs. In addition, a key JRA aims at integrating the laboratories in Central and South-Eastern European countries into the European landscape by developing novel technologies and methodologies that could be used both at these laboratories and elsewhere in Europe. These developments will give a strong impetus to these emerging laboratories and their communities and enhance their external use. Particular importance is attributed to research work that might lead to multidisciplinary or industrial applications.

## **SPIRIT**

SPIRIT is an Integrating Activity funded by the European Commission in Framework Programme 7. SPIRIT integrates 11 leading ion beam facilities from 6 European Member States and 2 Associated States. Seven partners provide Transnational Access to their facilities. Various types of ions are supplied in an energy range from below 10 keV to more than 100 MeV for modification and analysis of solid surfaces, interfaces, thin films and soft matter, in particular on the nanometre scale. The techniques cover materials, biomedical and environmental research and technology, and are complementary to the existing synchrotron and neutron radiation networks. The partners offer highly complementary equipment and areas of specialisation.

SPIRIT increases user access and the quality of research by sharing best practice, balancing supply and demand, harmonising procedures and extending the services into new emerging fields and to new users especially from the New Member States and industry. An independent European user selection panel examines proposals for Transnational Access applying a common SPIRIT procedure. SPIRIT's Networking Activities include the development of common standards for quality assessment; training and consultancy for user researchers and foresight studies.

Joint Research Activities promote emerging fields such as targeted single ion implantation for irradiation of living cells; ion-beam based analysis with ultra-high depth resolution; ion-based 3-D tomography, and chemical and molecular imaging. Joint efforts are also made to improve the systems for detection of ion-induced secondary radiation and the associated software and to develop means to reduce sample deterioration by the analysing ion beam.

## 3. Research Infrastructures and Networking

---

### ERA-NETs

ERA-NETs have been implemented by the EU in Framework Programme 7 to foster the collaboration of national funding agencies at the European level and support them in establishing joint projects.

### NuPNET

NuPNET is the ERA-NET for Nuclear Physics. It was established in 2007 to provide Europe with a more coherent funding scheme for this field of science. NuPNET includes 18 European funding agencies representing 14 countries. Its member organisations are the most important agencies that fund nuclear physics Research Infrastructures and associated equipment in Europe. In Europe, the challenge is to harmonise the national programmes for Nuclear Physics to create a stronger and more cohesive research area, which is truly European in scope.

NuPNET will provide the tools that all European institutions funding nuclear physics research can use to plan a coherent development of the subject.

The goals set by the NuPNET Consortium are as follows:

- Goal 1: Acquire a mutual and better understanding of the funding of nuclear physics infrastructures and associated equipment in Europe that is needed for future collaborative projects. The communication between administrators in Europe needs to be intensified in order to develop effectively infrastructures of truly European scope.
- Goal 2: Propose a set of joint transnational activities (based on the science priorities set in the Long-Range Plan of NuPECC) that can be launched by the funding agencies thanks to the NuPNET co-ordination.
- Goal 3: Launch one or more of those proposed joint transnational activities in the field of nuclear physics infrastructures development.
- Goal 4: Provide Europe with a sustainable funding scheme beyond the project duration.

The management of NuPNET ensures the overall co-ordination of these four goals as well as the coordination of specific activities; it disseminates the results and achievements of the project making it available to the public and increasing its external visibility.

Substantial work has been performed since the beginning of the project and several results have already been achieved. They are, in particular: i) several articles have been published in French and international magazines, ii) reports were given at meetings of NuPECC, ESFRI, FP7 research infrastructure connections, GANIL, SPIRAL2, ECT\* and the EU commission for liaison and communication purposes, and iii) Open Days were organised in the

form of workshops leading to very fruitful discussions and exchanges of ideas between funding agencies and ministerial representatives. The census of current European Nuclear Physics resources and agents was accomplished through a detailed questionnaire, extensive discussions and analysis, and lead to a very up-to-date picture of the field. The investigation into the priorities of the national funding agencies has produced a list of opportunities for possible joint transnational activities. A methodology for the “NuPNET Funding Action Plan” has been proposed. The selection and implementation of joint transnational activities is the final goal of this ERA-NET.

### European Physical Society

#### Nuclear Physics Board

The Nuclear Physics Division of the European Physical Society (EPS) has served the nuclear physics community of the European Physical Society for nearly four decades. According to its mission statement, the object of the division shall be to assist the advancement and dissemination of knowledge of nuclear physics. It correlates its work with other bodies representing nuclear physics, having e.g. cross-membership with NuPECC.

The Division has organised 25 International Divisional Conferences covering a wide range on nuclear physics from phase transitions, through applications to nuclear astrophysics. Recently it has initiated a new series of tri-annual European Nuclear Physics Conferences. The divisional activities include the organisation and approval of summer schools in this field of study and furthering the exchange of scientists and students, with an emphasis on encouraging collaboration between different regions of Europe.

The Division established two prestigious prizes, which recognise excellence in pure and applied nuclear physics, the Lise Meitner prize and the IBA prize. Understanding the need to promote the new generation of nuclear physicists, the Division, at its most recent meeting, agreed to set up a new prize for Young Physicists that recognises outstanding PhD work in the field.

In close collaboration with NuPECC, EPS recognised the need for public outreach to inform the public of nuclear science and set up the PANS (Public Awareness of Nuclear Science) board together with NuPECC. PANS originated from the idea that it is important to convey to the general public important issues associated with Nuclear Science. The assumption is that an informed public is better able to come to sensible judgements based on knowledge instead of prejudice.

The Division sees it as important to address difficult and controversial issues in the subject. For instance, it



---

has produced an independent review of Nuclear Energy production, which has been endorsed as a position paper by the EPS.

The Division strongly supports the extension of networking activities to develop new ideas and projects in nuclear physics. It also agrees that this is an optimum time to review the future direction of the subject and supports NuPECC in developing a new Long Range Plan.

### **European Committee for Future Accelerators**

ECFA is the European sub-committee of the International Committee for Future Accelerators, ICFA, which in turn is a working group of the International Union for Pure and Applied Physics, IUPAP. ECFA's remit is the long-term planning of European high-energy facilities, a task that, for Nuclear Physics, is performed by NuPECC. Since Nuclear and Particle Physics are cognate fields with common interests regarding the development of accelerators and large-scale experimental facilities, NuPECC has recently joined ECFA as an observer.

### **3.3.2 Global Collaboration**

European nuclear physicists have traditionally had close relations with their colleagues in other parts of the world. There has been an extensive exchange of people and ideas across the oceans. Numerous foreign scientists have performed innovative experiments at the large-scale Nuclear Physics facilities of their overseas partners.

#### **Sister Organisations Overseas**

##### **Nuclear Science Advisory Committee**

The counterpart of NuPECC in the USA is the Nuclear Science Advisory Committee, NSAC, which has been established jointly by the US Department of Energy, DoE, and the National Science Foundation, NSF. It provides scientific advice to these agencies, and, in particular, develops Long Range Plans for Nuclear Science in the United States. Since the remits and interests in e.g. relativistic heavy ion colliders, radioactive beam facilities, electron scattering laboratories and electron-nucleon/ion colliders are common to both committees, cross membership in NuPECC and NSAC has been established to collaborate even more closely across the Atlantic.

##### **Asian Nuclear Physics Association**

Since very recently another sister organisation, ANPhA, operates in Asia. It currently includes Japan, China, Taiwan, India, South Korea, Australia and Vietnam

and has been established according to the NuPECC model. Collaboration with ANPhA is particularly important for Europe, because a number of large-scale Nuclear Physics facilities have recently been built in Japan (Spring8, RIBF at RIKEN, J-PARC) and China (BES III at BEPC II in Beijing, BRIF at CIAE Beijing, CSR at HIRFL in Lanzhou, SLEGS in Shanghai) or are planned to be set up in the near future in e.g. China and South Korea (NLNS). NuPECC is closely collaborating with ANPhA and cross membership has been established in both committees.

##### **International Union of Pure and Applied Physics**

At the initiative of their C12 Commission on Nuclear Physics, IUPAP established the Working Group WG.9 on International Cooperation in Nuclear Physics in 2005. WG.9 is one of IUPAP's nine official Working Groups, with WG.1 being the International Committee for Future Accelerators, ICFA. NuPECC represents Europe on WG.9.

WG.9 has been mandated to review the key issues in Nuclear Physics on a time-scale of ten to twenty years, and identify projects that would benefit from a joint international effort. It has published its first report on these issues recently.

WG.9 strongly supported the foundation of ANPhA and of the Latin-America Nuclear Physics Association, ALAFNA. It currently helps establish a Nuclear Physics coordination committee in Africa.

##### **Organisation for Economic Co-operation and Development**

At the request of the USA, OECD's Global Science Forum, GSF, recently established a Working Group on Nuclear Physics to review the field at a global level. NuPECC was a member of this group, together with representatives of funding agencies from 20 OECD countries and the EU. GSF's report was published in 2008.

The working group confirmed that Nuclear Physics research is a major human endeavour that is funded at a level of two billion US dollars per year, with additional investments anticipated to be made over the next ten years of approx. four billion US dollars. It was stressed that quality-controlled open access to Nuclear Physics facilities should be maintained and that a closer collaboration between funding agencies globally might become necessary, when new large-scale research infrastructures are planned.



## 4. Scientific Themes

---

### 4.1 Hadron Physics

**Convener:** Ulrich Wiedner (Bochum)

Constantia Alexandrou (Nicosia),  
Mauro Anselmino (Torino),  
Reinhard Beck (Bonn),  
Mike Birse (Manchester),  
Tullio Bressani (Torino),  
Michel Guidal (Orsay),  
Thierry Hennino (Orsay),  
Frank Maas (Mainz),  
Ulf Meißner (Jülich/Bonn),  
Klaus Peters (Darmstadt),  
Andreas Schäfer (Regensburg),  
Madeleine Soyeur (Saclay),  
Antoni Szczurek (Kraków),  
Marc Vanderhaeghen (Mainz)

**NuPECC Steering Committee Member:**

Günther Rosner

**NuPECC Liaison:**

Jochen Wambach

## 4.1 Hadron Physics

---

### 4.1.1 Introduction

During the last century, Maxwell's electro-dynamics was combined with quantum theory into a field theory called quantum electrodynamics (QED). As a host of new particles were discovered experimentally, the determination of their properties helped to develop the theoretical framework further and there emerged a common understanding of the weak and the electromagnetic interactions. Built on these successes, the theory of the strong interaction, Quantum Chromodynamics (QCD), was developed on the exact colour symmetry SU(3) for the fundamental particles called quarks and the carriers of the strong force, the gluons. The Standard Model of particle physics was born.

In the Standard Model, all forces or interactions show basically the same behaviour, with a force law proportional to the inverse-square of distance. The proper sets of theories are called gauge theories. At this point, one can ask the question: where does hadron physics enter into this framework and what specific role does it play in our understanding of physics?

While high-energy physics works to identify the fundamental particles of nature, hadron physics seeks to understand the nature of composite particles, i.e., those composed of the fundamental quarks and gluons. In fact, it is only such composite particles that are observed in nature; the quarks and gluons themselves have never been seen in isolation. Two or three quarks together form a hadron, which therefore represents the first level of complexity in nature. The main problem of hadron physics is to understand this complexity in terms of elementary degrees of freedom – quarks and gluons – and their underlying non-abelian gauge theory of QCD. This problem is of utmost importance to the whole of contemporary physics, since on the one hand it paves the road to an *ab initio* understanding of even more complex strongly interacting systems such as nuclei, while on the other hand, it pushes forward the precision frontier in high-energy physics, where analyses in many cases are limited by the hadron physics input. Even the purely mathematical implications of the challenge posed by hadron physics are remarkable and worthy of one of the Millennium Prizes put forward by the Clay Institute.

When we try to understand strongly interacting composite particles at rest or at lower energies, it seems that the relevant degrees of freedom of the QCD Lagrangian are not the relevant ones for hadrons. We have two different pictures or scenarios evolving, depending on the scale under scrutiny:

**The perturbative regime** is explored in high-momentum processes such as deep-inelastic scattering (DIS) of leptons on hadrons. Here the observable properties are

directly related to the degrees of freedom that appear in the QCD Lagrangian (so-called current quarks and gluons). The momentum distributions of these particles, known as partons, within hadrons have been determined in great detail. It should be stressed, though, that at very low Björken- $x$  and high virtuality, gluon saturation sets in, forming the non-perturbative colour glass condensate.

**The nonperturbative regime** is relevant to the structure and interactions of hadrons at low momenta. The degrees of freedom needed to describe low-energy experiments, and hence quantities such as charge radii or magnetic moments, are not current quarks and gluons. Here first principles calculations can be performed with numerical simulations of QCD on a space-time lattice. Also, effective field theories based on hadron degrees of freedom can provide important information on how the symmetries of QCD constrain the interactions of these particles. In many cases, models based on “constituent” quarks with phenomenological masses can give better descriptions than one might expect, but these still lack any microscopic connection to the underlying theory of QCD. Detailed experiments on the spectroscopy of hadrons are needed to reveal the appropriate degrees of freedom.

Understanding the physics of hadrons requires a large variety of complementary experiments and theoretical tools. On the experimental side, electromagnetic and hadronic probes can be used to investigate various aspects of hadron structure and dynamics at different length scales. Here, the antiproton programme at the upcoming FAIR facility will play a very prominent role for the physics with charm and light quarks. On the theoretical side, recent progress in lattice simulations and effective field theories (or combinations thereof) has allowed *ab initio* calculations of hadron properties and interactions for the first time. The particularly important interplay between experiment and theory has already led to much progress in the field and will also play a central role in the future. Furthermore, many methods developed originally in hadron physics can be applied fruitfully in other fields of physics, leading to connections between very different areas of research.

After an introduction to the basic properties of QCD, the theory underlying all of hadron physics, this chapter is subsequently split into three topics that emerge naturally in modern hadron physics: hadron structure, hadron spectroscopy and hadronic interactions. At the end, we present a list of recommendations for the future development of the field of hadron physics.



---

## 4.1.2 Basic Properties of Quantum Chromodynamics

Quantum Chromodynamics (QCD) is a non-abelian gauge theory based on local  $SU(3)_{\text{colour}}$  invariance. The basic matter fields are spin-1/2 fermions with fractional electric charges that come in six flavours, the up, down, strange, charm, bottom and top. The interactions are mediated by eight massless gauge bosons, the gluons, which are also subject to self-interactions. This makes the field equations of QCD highly non-linear, leading to many fascinating properties. First, the running of the gauge coupling is driven by an intricate interplay of gluon and fermion loop effects, leading to asymptotic freedom at large energies and infrared slavery in the low-energy regime. In fact, quarks and gluons cannot be observed in isolation but only appear as colour neutral compounds, the strongly interacting particles – the hadrons. It is one of the most fascinating aspects of modern physics that the properties of the basic constituents of the underlying theory can only be indirectly inferred by studying the rich manifestations of the strong force in the structure, the decays, the production, the spectrum, and the interactions of the hadrons. Indeed one of the most challenging questions is to understand the emergence of the hadronic world in terms of the point-like and unobservable constituents.

The six flavours of quarks have masses that range from a few MeV to about 175 GeV. The masses of the lightest (up and down) are much smaller than the typical hadronic scale of  $\sim 1$  GeV, whereas the mass of the bottom quark is much larger than that scale. (The top quark has too short a lifetime to appear as a constituent of hadrons.) Consequently, hadrons made of light quarks require a relativistic description, whereas the hadrons made of heavy quarks alone can effectively be described in non-relativistic schemes. In between lie the strange quark with a current mass of about 100 MeV and the charm quark with a mass of 1.3 GeV. Important open questions are the extent to which these can be treated using methods appropriate to light and heavy quarks, respectively.

In the description of hadron properties and their dynamics, symmetries play central roles. In the light-quark sector, one can decompose the quark fields into left- and right-handed components, which are mixed only by the small quark masses. This leads to a chiral symmetry, which, however, is not explicit in the hadron spectrum. Rather it is hidden (spontaneously broken) by the condensation of quark-antiquark pairs in the QCD vacuum. This breaking has important consequences, since for each broken generator appear massless gauge bosons. This explains the peculiar property of the hadron

spectrum that the pions, the kaons and the eta have much smaller masses than all the other hadrons made of u, d, and s quarks. The non-vanishing mass of the  $\pi$ , K,  $\eta$  is due to the finiteness of the light quark masses.

Another intriguing property of light quark QCD is the role played by anomalies – symmetries of the classical theory that are broken by the quantization. Important are the breaking of the axial U(1) anomaly that lifts the mass of the  $\eta'$  to the typical hadronic mass, the trace anomaly that governs the balance of field versus matter energy in the mass budget of the hadrons and chiral anomalies that lead to parameter-free predictions for certain meson interactions.

In contrast, the heavy quark sector displays a quite different pattern of symmetry breaking. Since all fine and hyperfine structure effects are suppressed by inverse powers of the heavy-quark mass, this possesses an exact spin and flavour symmetry in the limit of infinitely heavy quarks. This leads to a variety of relations between various heavy meson decay form factors that are of major importance in the extraction of certain CKM matrix elements from heavy meson decays.

Finally there are so-called heavy-light systems, containing a single heavy quark. These can be best treated as an almost static source surrounded by a cloud of light particles. Here both heavy-quark and chiral symmetries provide constraints that must be respected by any systematic analysis of their properties.

For most aspects of hadron physics, the gauge coupling is so large that it requires non-perturbative methods to analyse the structure and dynamics of hadrons. The two most powerful tools are lattice QCD (see Box 1) and effective field theories (EFTs) (see Box 2), supplemented by renormalization group methods, dispersion relations and models, like e.g. the constituent quark model or meson-exchange models. While lattice QCD operates with the underlying degrees of freedom, the quarks and the gluons, EFTs are formulated in terms of the appropriate hadronic degrees of freedom and provide a crucial tool for analysing the properties and interactions of hadrons and nuclei.

## 4.1 Hadron Physics

**Box 1.** Lattice QCD is formulated on a discrete space-time and allows for *ab initio* calculations of hadron properties using Monte Carlo techniques to numerically solve the corresponding path integral. Due to the recent progress in high performance computing and significant theoretical progress combined with better algorithms, one is now capable to simulate QCD for light quark masses close to their physical values. The lattice artefacts due to the finite lattice spacing, the finite volume and the variation of the quark masses down to their physical values can all be analysed in terms of suitably tailored effective field theories. This is a major development in QCD and as a very prominent example the successful calculation of the hadron spectrum made from light quarks of the BMW collaboration is shown here.

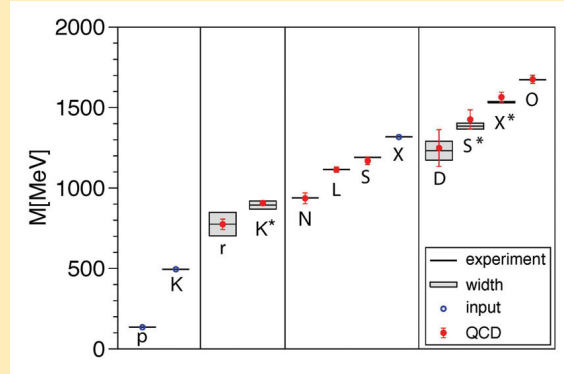

**Figure 1.** Lattice QCD calculation of the low-lying hadrons made of u, d and s quarks

**Box 2.** Effective field theories can be applied to systems that exhibit a separation of scales. Consider e.g. a theory with some light and some heavy degrees of freedom with masses  $m$  and  $M$ , respectively. If one considers processes with energies and momenta of the order  $E \sim p \sim m$ , the heavy degrees of freedom can not be resolved and their contribution be described in terms of light particle contact interactions, whose strengths can be expressed in terms of the heavy masses and coupling constants. Even without knowing their values, EFT allows to set up a predictive and perturbative scheme, where each matrix-element is expanded in powers of  $p/\Lambda$ , with  $\Lambda$  a hard scale,  $\Lambda \leq M$ . At each order in the expansion, a certain number of couplings related to the contact interactions have to be fixed by a comparison to data and then predictions for other observables can be made. At each order  $n$ , the accuracy of the calculation can be estimated to be of order  $(p/\Lambda)^{n+1}$ , thus providing a measure of the theoretical precision. The two most important EFTs for hadron physics are chiral perturbation theory (ChPT) and heavy quark EFT (HQEFT), which allow one to analyse the structures of the approximate chiral and the heavy quark symmetry in the light and the heavy quark sectors, respectively.

### 4.1.3 Hadron Structure

The structure of the nucleon is a defining problem for hadron physics, much as the hydrogen atom structure is to atomic physics. The solution of the hydrogen atom was achieved due to a remarkable interplay between theory and experiment. The initial understanding of the basic structure of the hydrogen atom triggered the development of quantum mechanics. As the precision frontier in atomic physics shifted, the measurements of the Lamb shift, of the electron's anomalous magnetic moment, and of the hydrogen hyperfine splitting were crucial in shaping the relativistic quantum field theory of electromagnetic interactions. A hallmark of the resulting theory, QED, is its ability to predict atomic structure observables to high accuracy, as a perturbative expansion in the fine structure constant ( $\alpha_{em} \sim 1/137$ ). QED, describing the electromagnetic interaction between charged particles through the exchange of spin-1 gauge bosons, photons, also served as a paradigm to formulate field theories for other interactions in nature.

Today, a similar interplay between theory and experiment in the study of hadron structure provides us with a unique opportunity to explore the richness of the underlying non-abelian quantum field theory, QCD, in its different regimes. On distance scales smaller than about 0.1 Fermi, the asymptotic freedom property of QCD allows for a perturbative expansion in the gauge coupling. State-of-the art calculations to higher orders allow the theory to be tested in hard processes involving large momentum transfers. In contrast, at distance scales of the order of 1 Fermi, the size of a nucleon, the running coupling becomes large, and one leaves the realm where perturbative expansions in the gauge

coupling can be applied. A key tool to extract hadron structure information in this non-perturbative regime is the property of factorisation. It makes it possible to separate cleanly the high-momentum (perturbative) and the low-momentum (non-perturbative) aspects of the interaction.

In this way, hard reactions such as inclusive deep-inelastic scattering (DIS), semi-inclusive DIS, or hard exclusive reactions are routinely used nowadays as probes of hadron structure. It is the hard scale involved in these processes, which allows a perturbative QCD description of the reaction and which selects well-defined operators in terms of quarks or gluons. By measuring the matrix elements of such operators in the hadron, we can then extract the soft part of the amplitude, which lies in the realm of non-perturbative QCD. Depending on the operator selected, key questions on hadron structure can be addressed, such as:

- How are quarks spatially distributed inside the proton?
- Can we understand the energy-momentum and angular-momentum dependent aspects of the structure of hadrons from first principles?
- Is there a connection between orbital motion of quarks and gluons, their spin and the spin of the proton?

- How does the internal structure of baryons and mesons emerge from the dynamics of quarks and gluons?
- What are the contributions of different quark flavours to hadron structure?

## Recent Achievements, Current State-of-the-Art

To address the above questions, hadrons are explored experimentally by studying their response to high-precision probes at various energies. Electroweak probes offer versatile and well-understood tools to access the internal quark-gluon structure of hadrons. With the relatively weak coupling strength of the electromagnetic interaction, resulting dominantly in one photon exchange, a clean separation of the probe and the system under investigation is possible. This is true for processes with photons or charged leptons in the initial or in the final state. Typical examples are electron scattering or the observation of lepton pairs from decays or Drell-Yan type processes. Equally important is the fact that the virtuality of the exchanged photon can be tuned. This allows the spatial structure of hadrons to be resolved and the distributions of their constituents to be studied.

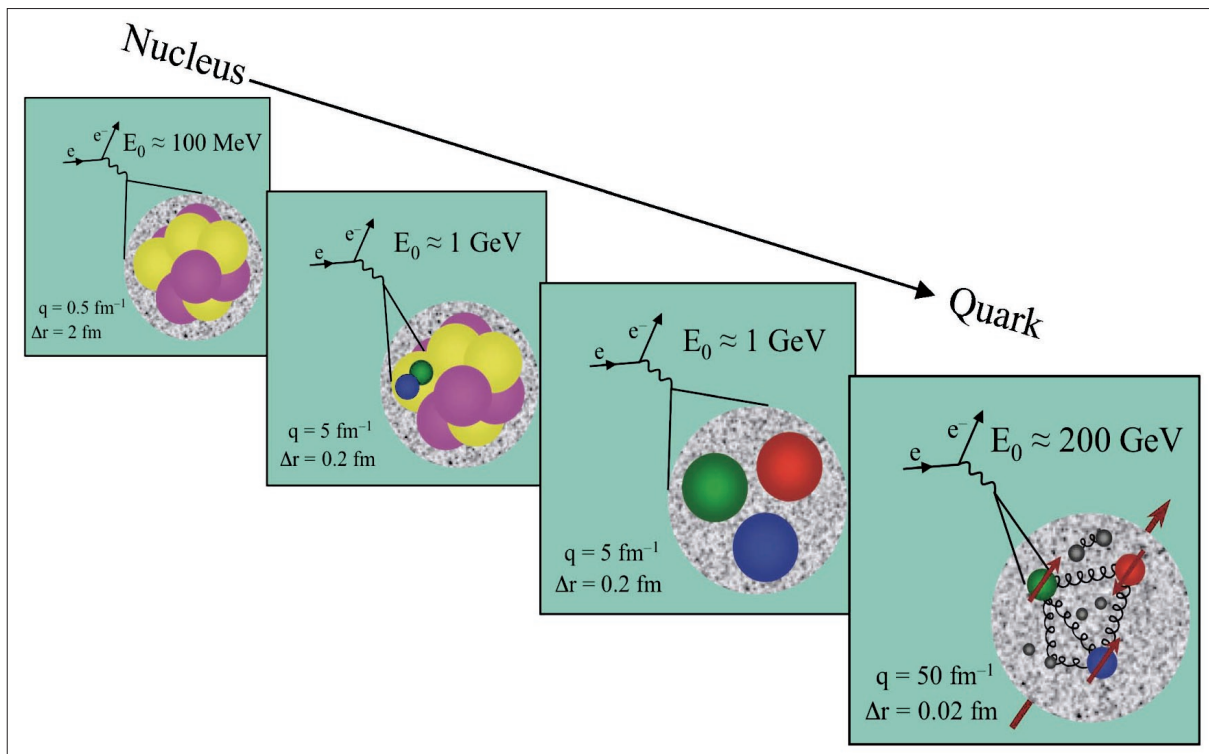

**Figure 2.** Different projectile energies test different properties of the nucleon structure.

## 4.1 Hadron Physics

---

Elastic scattering and inclusive DIS processes are time-honoured tools to access hadron form factors and structure functions respectively. The space-like electromagnetic form factors reveal the spatial distribution of quark charges in a hadron, whereas the structure functions measure the longitudinal momentum distributions of partons in a hadron. However, a full 3-dimensional exploration of the nucleon structure, in position and momentum space, has only just begun. For this purpose, several correlation functions encoding the quark-gluon structure have emerged in recent years. The correlation between the quark/gluon transverse position in a hadron and its longitudinal momentum is encoded in generalized parton distributions (GPDs). The information on the quark/gluon intrinsic motion in a hadron and several correlations functions that describe this 3-dimensional structure have been devised in recent years.

Over the last few years a rich experimental programme has developed to measure these different correlation functions, and significant advances are anticipated in the future. This field is based on a fruitful interplay between experiments, phenomenological treatments of the relevant matrix elements, and *ab initio* calculations of these matrix elements from lattice QCD.

In the following we describe in more detail the state-of-the-art of the different hadron structure observables and spell out the open issues in these fields.

### Electromagnetic Form Factors

The electromagnetic form factors (FFs) of hadrons, most prominently of nucleons, have been studied with ever increasing accuracy over the last 50 years. The main tool has been elastic lepton scattering, which probes negative (space-like) momentum transfers. Positive (time-like) momentum transfer is accessible in annihilation processes. Due to their analyticity in the 4-momentum transfer  $q^2$ , space-like and time-like FFs can be connected through dispersion relations. In the space-like region, they allow for a spatial imaging of quarks in a hadron, whereas in time-like region, they encode the excitation spectrum of spin-1 (vector) mesons. These two complementary aspects of hadron structure demand a determination of the electromagnetic FFs over the full kinematical range of  $q^2$ .

On the theory side, a wide variety of models based on effective degrees of freedom has been used to estimate the nucleon's FFs. Form-factor data also provide benchmarks for lattice gauge theory, in particular, for systematic studies of the approach to physical values of the quark masses. Furthermore, space-like FFs yield the first moment (over the quark longitudinal momentum fraction) of GPDs (see below). Dispersion relations are

used to analyse the structure of the FFs in the space- and time-like region simultaneously.

As well as revealing information on the spatial structure of hadrons, FFs provide vital input for interpreting precision experiments in other fields of physics. A well-known example is the hydrogen hyperfine splitting, where the main limiting theoretical uncertainty lies in proton structure corrections. A further example for the need of precise FFs are the experiments on parity violating electron scattering, where the uncertainty in the extraction of strange FFs via axial and electromagnetic FFs limits the current experimental precision.

For electric and magnetic FFs of the proton and neutron at space-like momentum transfers, there are active experimental programmes at MAMI (at lower momenta) and at JLab (with higher momenta). The availability of CW electron beams at high current and high polarisation allows measurements with unprecedented accuracy up to high energies due to the large available luminosities and – for experiments with polarisation – large figures of merit. The interest in the nucleon FFs has been renewed especially by recent measurements at JLab using the polarization transfer method. These show that the ratio of electric and magnetic FFs for the proton deviates from unity, in contrast to the results derived from the Rosenbluth separation technique. While this discrepancy is most likely connected with two-photon exchange amplitudes, it has been shown that the polarization transfer method is much less sensitive to those effects and therefore yields clean FF extractions.

The question of the importance of the two-photon exchange amplitude in elastic scattering has triggered a whole new field of research. Several dedicated programmes, comparing elastic scattering of electrons with elastic scattering of positrons from protons are underway at JLab, at the Novosibirsk  $e^+e^-$  collider VEPP2000, and at the Doris ring at DESY.

In the time-like region, where the FFs are complex functions of  $q^2$ , the most precise experimental data have come from the B-factory  $e^+e^-$  colliders, where the centre-of-mass energy is fixed at a bottomium resonance, and from antiproton annihilation experiments at LEAR. The limited statistics of current data mean that an independent extraction of the time-like electric and magnetic FFs is not possible. The present error of the ratio of electric over magnetic FF in the time-like domain is of order 50%, in contrast to the space-like regime, where the precision is almost two orders of magnitude better. At B-factories, radiation of a photon from one of the particles in the initial states is used to vary the  $q^2$  of the virtual photon that probes the nucleon. The BESIII experiment at Beijing has recently started data taking. The PANDA experiment at GSI/FAIR offers a unique



opportunity to determine the moduli of the complex FFs in the time-like domain over a wide range of momentum transfers from antiproton annihilation reactions, with expected statistical errors 20 to 50 times smaller than those on present data.

In addition to the measurement of electromagnetic FFs there has been an extended experimental programme on measuring the weak form factors of the nucleon by parity violating electron scattering experiments at JLab and at MAMI. Due to the electroweak mixing, a measurement of parity violating asymmetries of order parts per million allows a very clean study of the contribution of the strange sea quarks to the electromagnetic FFs of the nucleon.

### Parton Distributions

The internal quark-gluon structure of hadrons, which is accessed in inclusive DIS of high-energy leptons off nucleons, is encoded in a well-defined hierarchy of correlation functions. The simplest of these are the unpolarised and polarised parton distribution functions (PDFs), which give the number density of partons of type  $q$  inside a proton, carrying a momentum fraction  $x$ . Similar information, although less detailed, has been obtained about the number density of longitudinally polarised partons inside longitudinally polarised protons, the helicity parton distribution. The successful prediction of the scale dependence of the PDFs has been one of the great triumphs of QCD.

A long-standing puzzle is the fact that only about one third of the spin of the proton is carried by the spins of the quarks. This has been addressed in several ways over the last decade. One suggestion is that the quark spin contribution is masked by a very large gluon polarization, contributing via the axial anomaly. One way to test this is to measure production of single hadrons or had-

ron pairs in semi-inclusive DIS, which provides access to the gluon polarization through photon-gluon fusion. Recent data from COMPASS and HERMES, shown in Figure 3, point to a rather small value for this polarization, at least in the accessible range of  $x$ , now making this scenario unlikely.

The measurement of open charm production instead of that of light hadrons in DIS reduces the model dependence of the analysis due to the absence of charmed quarks in the nucleon. Recent data from COMPASS allow a first determination of the contribution to the nucleon's spin from the gluon helicity distribution, also shown in Figure 3. The data for this quantity are compatible with zero, however the errors are still large and the accessed  $x$ -range is limited.

Recent data from semi-inclusive DIS at HERMES point towards a substantially smaller polarised strange quark sea than previously assumed, but this is still controversial in relation to global fits to DIS data.

### Transverse-Momentum-Dependent Parton Distributions

A fast moving proton can be viewed as a bunch of collinearly moving quarks and gluons. Its inclusive reactions can provide only limited information on the relative motion of these partons. More details of this intrinsic motion are encoded in the transverse-momentum-dependent distribution functions (TMDs). These include spin-dependent correlation functions that link the parton spin to the parent proton spin and to the parton intrinsic motion. The 8 leading-twist, parity invariant TMDs include the unpolarized, the helicity and the transversity distributions, which are the only ones to survive in the collinear limit. Similar correlations between spin and transverse motion can occur in the fragmentation process of a transversely polarised quark into a (non-collinear) hadron. The fragmentation function gives the number density of hadrons resulting from the hadronisation of a parton.

A systematic attempt to study TMDs started a decade ago, with both dedicated experiments and new theoretical ideas. In this context, the crucial innovation is the study of physical observables that are sensitive to the transverse-momentum-dependent distributions. These are sensitive to the transverse polarisation structure of the nucleon and can be extracted from semi-inclusive deep-inelastic scattering (SIDIS). The measured hadron in the process results from fragmentation of a struck quark and "remembers" the original transverse motion of that quark. New information on this is obtained by analysing the cross-section data as convolutions of TMDs and fragmentation functions.

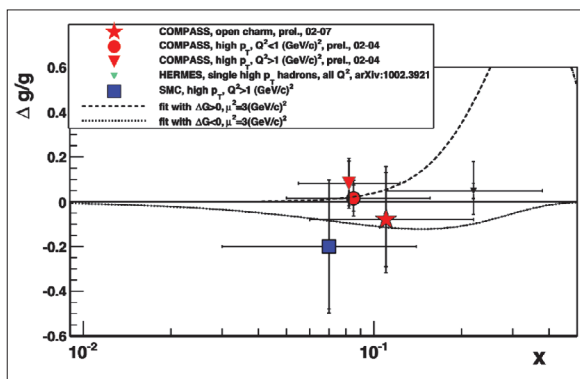

Figure 3. Gluon polarization results from SMC, HERMES, and COMPASS, in comparison with theoretical fits

## 4.1 Hadron Physics

Dedicated experiments (HERMES@DESY, COMPASS@CERN and JLab) have provided important new results, showing transverse spin effects. Future results in this field are expected from COMPASS and from JLab experiments, either running or planned at an upgraded energy of 12 GeV. The spin structure of the proton is also being investigated at RHIC, with polarised proton-proton scattering. New electron-nucleon (ENC) or electron-ion colliders (EIC), with polarised beams and targets, planned in Europe and the USA, will be dedicated facilities for accessing TMDs.

The transversity distribution, being a chiral-odd quantity, can be measured only when coupled to another (unknown) chiral-odd quantity; this has been recently achieved by combining SIDIS and  $e^+e^-$  data. More precise experiments, spanning different ranges of  $x$  and  $Q^2$  are essential. The “golden” channels for this would be double-transverse-spin asymmetries in Drell-Yan processes with polarised antiprotons, as proposed by the PAX Collaboration at FAIR.

A non-vanishing “Sivers” effect (relating the intrinsic motion of unpolarised partons to the parent nucleon spin) has been observed in SIDIS by the HERMES for the proton. Similar measurements by COMPASS on the deuteron yield asymmetries compatible with zero. A confirmation of the HERMES findings for the proton is therefore vital, since this would provide a clear indication of parton orbital motion. Furthermore, the Sivers function is predicted to contribute with opposite signs to single-spin asymmetries in SIDIS and Drell-Yan processes. The Drell-Yan measurements could be performed in a hadronic run (pions scattering off transversely polarised protons) at COMPASS. A transversely polarised target in the future PANDA experiment could also access such processes.

The Collins effect (relating the transverse spin of a fragmenting quark to the transverse motion of the resulting hadron) has been independently observed by three different experiments, HERMES, COMPASS and Belle. One remaining theoretical issue related to the Collins functions, and TMDs in general, is their QCD evolution.

### Generalized Parton Distributions

In recent years, much progress has also been made in a different direction by developing a broader framework of so-called Generalised Parton Distributions (GPDs). These structure functions can be probed in hard exclusive leptonproduction of a photon (deeply virtual Compton scattering, DVCS) or a meson. In the forward limit they reduce to the PDFs. GPDs extend the two-dimensional transverse spatial picture of the nucleon, accessible through the form factors, to a third dimension, by correlating it with the longitudinal quark momentum components. This dependence on the transverse spatial motion means that GPDs can provide, through a sum rule derived by Ji, a handle on the contribution of the orbital angular momentum of the quarks to the nucleon’s spin.

Determination of the GPDs forms a long-term experimental programme, requiring measurements of observables for various channels over a wide kinematical range. Including constraints from dispersion theoretical techniques, one can reduce the model dependence in the extraction of GPDs. In order to test the scaling limit, it is also, in particular, necessary to reach  $Q^2$  values as large as possible so that the leading-order GPD formalism applies.

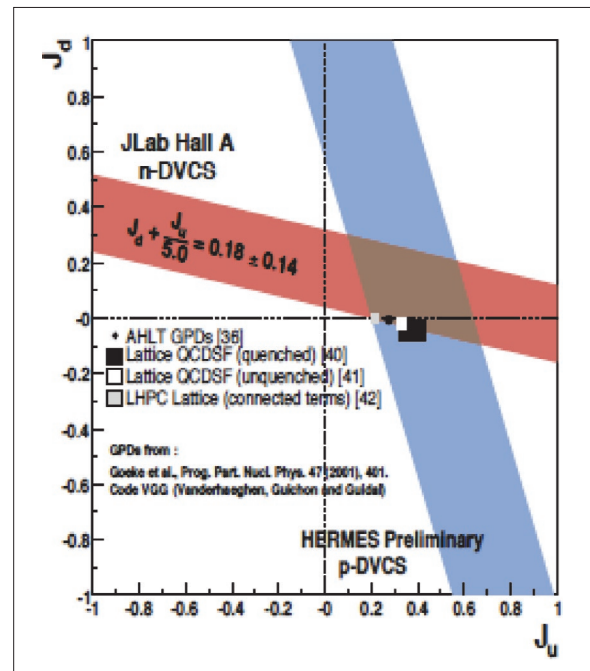

**Figure 4.** Model-dependent constraints on the u-quark total angular momentum  $J_u$  vs. d-quark total angular momentum  $J_d$  obtained by comparing JLab and HERMES DVCS experimental results and theoretical model calculations.

---

A broad experimental programme has been explored over the past years at several facilities and experiments: at JLab with a 6 GeV electron beam, at HERMES with a 27 GeV electron and positron beam, and at H1 and ZEUS with 820 GeV protons colliding with 27 GeV electrons or positrons. Available DVCS data already allow us to make some comparisons to models and are providing insights into the nucleon GPDs. For example, with the help of Ji's sum rule, one can make a first model-dependent estimate of the orbital momentum contributions of the u and d quarks to the nucleon's spin, see Figure 4. This hints at a nucleon where d quark angular momentum contributes little to the proton's spin, a large part of it originating therefore from the u quarks.

In the near future numerous high statistics data employing many channels and observables – for DVCS in particular – are expected from the 6 GeV beam at JLab. New, fully exclusive, beam charge asymmetries and beam spin asymmetries should be available in the next couple of years. After 2010, the COMPASS experiment at CERN also plans to study GPDs with a 200 GeV muon beam. As at HERMES, a dedicated recoil detector will be installed in order to detect all the particles of the DVCS final state and ensure the exclusivity of the process. Also in the near future, high statistics data on many channels and observables are expected from the 6 GeV beam at JLab.

In the longer term (> 2013), the JLab upgrade, with a 12 GeV beam, promises to yield a wealth of new experimental data that will reach into new kinematical domains. In both Europe and the USA, high luminosity polarised electron-nucleon/ion collider projects (ENC / EIC) are under discussion. Whilst fixed-target experiments explore mainly the valence region, a collider experiment could significantly extend the leverage in  $Q^2$ , thus providing a test of the underlying scaling behaviour in both unpolarised and polarised observables, required for extracting GPDs. Furthermore, it could also probe the region where gluons as well as quarks play a significant role in the nucleon's structure.

A further generalization of the GPD concept has been proposed in cases where the initial and final states are different hadronic states. When these new hadronic objects are defined through a quark-antiquark (respectively, three quark) operator (meson to meson or meson to photon transition), they are called mesonic (respectively baryonic) transition distribution amplitudes (TDA), The study of hard exclusive lepton pair production accompanied with a pion in antiproton-proton annihilation at FAIR e.g. will allow extracting such TDAs.

## Lattice QCD

The next round of lattice QCD (LQCD) simulations should result in calculations of several of the hadron-structure observables discussed above, close to the physical point and with carefully controlled uncertainties. The hadron spectrum calculation already mentioned demonstrates that it is only a matter of time before LQCD leads to the evaluation of many hadron-structure quantities with similar accuracy. In particular, the combination of experiment, perturbative QCD and LQCD is already providing a powerful framework for understanding the rich physics of hadron structure. During the coming decade, developments combining these three elements will further intensify.

The fact that in LQCD calculations several fermion lattice actions is an illustration of the non-trivial technical challenges in this area. The goal is to provide results with the smallest overall error. With given computational power, this can entail a trade-off between statistical and systematic errors. Theoretical progress over the years has allowed for a reduction cut-off effects and restoration of chiral symmetry on the lattice without unwanted fermion species, at the expense of more complicated actions that require greater computer resources. The best strategy at present is to use a number of improved actions and regard the spread of predictions as a measure of the systematic errors. Only when lattice artefacts are correctly accounted for, can comparisons with continuum physics be meaningful.

Up to now the extrapolation to physical light-quark masses (or equivalently pion masses) has been a major source of uncertainty. This extrapolation was needed because LQCD simulations at unphysically large light-quark masses are much less demanding of computer resources. With increasing computer power, combined with algorithmic improvements and steadily improving input from chiral effective theory (ChPT), it is expected that the gap between lattice simulations and the physical point will be bridged in the next couple of years.

Lattice calculations at the physical quark masses will still need corrections for finite volume and discretisation effects. ChPT can provide insights into the volume and cut-off dependences of lattice quantities, and these can be very valuable for carrying out the infinite-volume and continuum extrapolations. Current LQCD simulations make use of lattices with spatial sizes  $L$  such that  $Lm_\pi \geq 3.5$  and spacings smaller than 0.1 fm. These make it extremely important to determine finite-volume corrections and cut-off dependences from effective field. Only then will it be possible to draw rigorous conclusions from lattice QCD for quantities like orbital angular momenta, moments of GPDs, or distribution amplitudes.

## 4.1 Hadron Physics

---

### European and Global Perspectives

In Europe there are several major institutes with active experimental research programmes in hadron-structure physics. In France, there are CEA/Saclay and INP at Orsay, and also the Universities of Clermont-Ferrand and Grenoble which are involved at MAMI, at JLab in the USA, and in the CERN COMPASS programme. The same is true of several institutes in Italy, namely the INFN sections at Frascati, Torino, Trieste, Pavia, Ferrara, Genova and Trento. There is a long-standing collaboration and exchange among these institutes, which will definitely be continued and intensified. The contribution of British universities at Glasgow and Edinburgh to hadron-structure explorations is substantial. The Universities of Bonn and Darmstadt are running electron accelerators comparable to the MAMI facility at Mainz. Mainz University has initiated a discussion on teaming up with Bonn University and the Research Centre Jülich for an ambitious new project at GSI/FAIR, the Electron-Nucleon Collider (ENC). Studies for such a collider using the HESR are being pursued with the aim of establishing a common physics programme, which could be pursued as an international project. CERN with its COMPASS programme at the SPS recently invited the hadron community to submit new proposals for fixed-target experiments. In the USA, there is a rich hadron-structure programme at the Brookhaven National Laboratory, including studies of the proton spin at the RHIC collider. The high energy of that machine means that cross sections for electroweak processes are large and can be used to extract hadron structure information. In addition RHIC is making plans for a future electron-nucleon collider (eRHIC, MEeRHIC, EIC). MIT Bates has stopped data taking at its electron linac/storage ring complex and is now pursuing the EIC project. JLab at Newport News in Virginia currently operates the 6 GeV CEBAF accelerator and has a future programme on structure and spectroscopy of hadrons based around an upgrade of the existing accelerator complex to 12 GeV beam energy. It is also pursuing possible electron-nucleon collider projects at different levels (ELIC). Another approach to hadron structure physics is provided by the current  $e^+e^-$  facilities at Frascati (Daphne), Beijing (BEPC), and at Tsukuba (KEK B-Factor with the Belle experiment).

### Medium- and Long-Term Strategy

The development of the FAIR facility at GSI is of the highest priority for the future of the field. The PANDA experiment at the HESR storage ring is primarily a spectroscopy experiment, but will allow precise determinations of many nucleon structure observables as well, such as time-like form factors, time-like generalised parton distributions, transverse momentum distributions

and much more. This information will be partly complementary to space-like observable studies at other accelerator facilities. In the meantime, the continuation of the rich hadron structure experimental and theoretical programme at the various current accelerator facilities should therefore be of the highest importance.

A new high-luminosity, high-polarisation electron-nucleon collider with a centre-of-mass energy larger than 10 GeV would allow a precise determination of parton distributions, generalised parton distributions and transverse momentum distributions over a wide  $Q^2$  range. This would also lead to much improved knowledge of the spin and flavour space-time structure of quarks and gluons inside the nucleon. In addition to the reconstruction of the momentum dependent spatial distribution of quarks and gluons inside the nucleon, the transverse spin distribution could be precisely measured, as well as the longitudinal spin distribution of quarks and gluons and the quark angular momentum.

Electron-nucleon colliders for hadron structure are currently under discussion at different places in the US (MEeRHIC at BNL and medium energy ELIC at JLab) as well as in Europe (ENC at GSI/FAIR). The ENC would use the HESR ring at FAIR for polarised protons and add an 3.3 GeV electron beam, yielding a centre-of-mass energy of about 14 GeV with high polarisation and a luminosity of about  $6 \cdot 10^{32} \text{cm}^{-2} \text{s}^{-1}$ . A moderately modified PANDA detector would be used. A feasibility study for both the physics programme and the high luminosity accelerator has recently started.

Structure and spectroscopy of hadrons reveal complementary aspects of strong interaction physics using different methods and particle beams. An electron-nucleon collider as a future upgrade to FAIR would allow the spectroscopy studies using PANDA experiment to be complemented by an advanced nucleon-structure programme.



## 4.1.4 Hadron Spectroscopy

### Recent Achievements and Hot Topics

Hadron spectroscopy has been and still is a vital but also mysterious field of QCD. Its fundamental degrees of freedom, the quarks and the gluons, have never been observed in isolation, but appear only in colour-neutral states, the hadrons. Colour neutrality seems to be a very restrictive criterion. Most simply it can be achieved by combining one quark and one antiquark to form a meson or three quarks to form a baryon. However, there is a variety of other ways to satisfy the principle of colour-neutrality, such as tetra- and pentaquark systems. The former are mesons made from two quarks and two antiquarks, while the latter are composed of four quarks and one antiquark. In addition, due to their self-interaction, the gluons can form bound states by themselves, the so-called glueballs. Colour-neutral combinations of quarks with gluons contributing to the overall properties are called hybrids.

Both glueballs and hybrids can have quantum numbers that are not allowed for the simplest  $q\bar{q}$  or 3-quark combinations, providing a unique experimental signature. However, as already pointed out by Dalitz and collaborators many decades ago, yet another form of

hadronic bound states can exist, the so-called hadronic molecules. In the vicinity of a two-particle threshold or between two close-by thresholds, attractive S-wave interactions can bind a pair of mesons or a meson and a baryon to form this type of resonance. Given this rich set of possibilities, it is one of the mysteries of QCD that so far only quark-antiquark and three quark states have firmly been established.

The question of “exotic” bound states has gained prominence over the last few years as a result of the observation of a number of unexpected states in the charmonium spectrum, many of them close to two-particle thresholds. In particular the discovery of open- and hidden-charm mesons with unexpected properties has challenged our understanding of the QCD bound state spectrum. First, the charm-strange mesons  $D_{s0}^*$  (2317) and  $D_{s1}$  (2460) discovered by BaBar did not fit into the expected quark model spectrum. Various interpretations as tetraquark states or DK molecules have been advocated, which can also explain their unusual decay patterns. Subsequently, a variety of hidden-charm mesons, nowadays referred to as X, Y, Z states (see Figure 5), were discovered.

In most cases these states are associated with charmonium since the decay products contain charm quarks but their classification is far from obvious. It is not clear why, despite being above the open-charm threshold, strong decays into open-charm states are suppressed and the states decay rather into a charmonium ground state and light mesons. If some of them were hybrids this could be an indication of the long lifetime and small width of gluonic excitations. The states close to two-particle thresholds are conjectured to be hadronic molecules, the most prominent of these being the X(3872) which lies within 0.5 MeV of the  $D^+D^0$  threshold and which decays into  $J/\psi\pi^+\pi^-$  and  $J/\psi\pi^+\pi^-\pi^0$  with similar rates.

The  $Z^+$  particles must be multi-quark states containing two lighter quarks together with the charm and anticharm quarks, implying that new combinations of degrees of freedom in the strong interaction have started to show up. Current experiments cannot add much more information, because the observed particles are produced in a decay chain and so, for example, the knowledge of their widths is limited by detector resolution. Where tested, these states couple strongly to antiproton-proton annihilations, as shown by results from experiments at LEAR and also at Fermilab experiments. In most cases, limited detector resolution will not be an issue at FAIR due to the possibility of directly scanning the resonances with a high-precision antiproton beam. This should allow PANDA to clarify the nature of the X, Y and Z states.

The search for glueballs and hybrids in the mass region where only the lightest quarks play a role has so

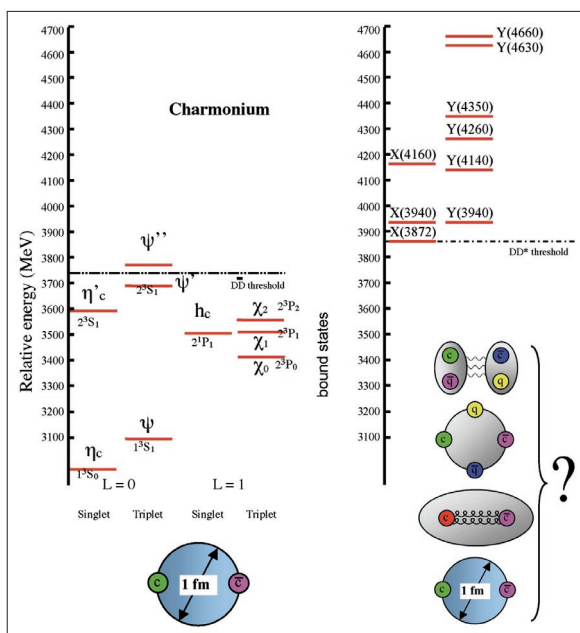
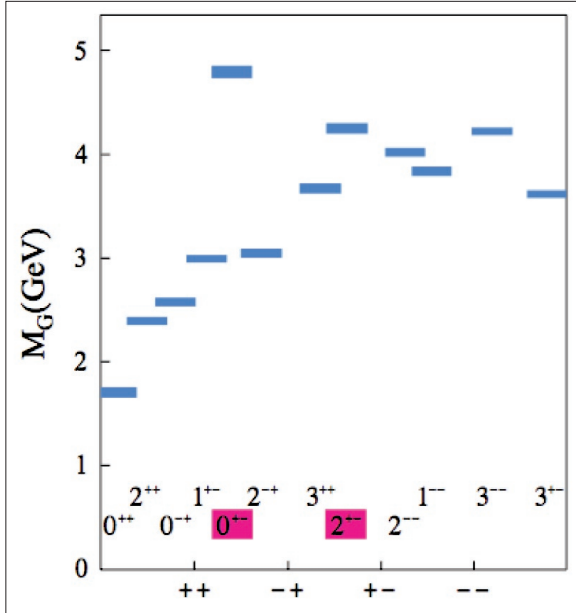

Figure 5. The established charmonium spectrum is shown on the left side. On the right side newly discovered X and Y states with unusual properties and as yet unknown nature are plotted.

## 4.1 Hadron Physics



**Figure 6.** The glueball spectrum as predicted by lattice calculations. Exotic quantum numbers are indicated by colour.

far been inconclusive. An obvious problem is the sheer number of states, often overlapping in width and mixing, which makes their identification and classification difficult. Therefore the glueball candidate  $f_0(1500)$ , although experimentally clearly seen, cannot be unambiguously identified as such. While lattice simulations can make crisp predictions for the glueball spectrum in the pure-gauge theory without quarks, the mixing of states in the presence of light quarks remains to be a challenge. In terms of hybrid searches, two states, the  $\pi_1(1400)$  and the  $\pi_1(1600)$  have been seen by several experiments. Even though no firm claim about their hybrid character can be made, the exotic quantum numbers show that states with degrees of freedom beyond a quark-antiquark pair are now appearing in meson spectroscopy. More progress in this field is also expected from experiments with hadron beams, in particular the meson spectroscopy programme with COMPASS at CERN.

There has also been considerable progress in the spectroscopy of baryons. The constituent quark model was accepted for many years as the starting point for this field. It can explain much of the regularity in the spectrum but it also has some obvious failures. The most obvious one is the different ordering of the positive and negative parity states, in particular the difficulty in reproducing the low masses of the  $N^*(1440)$  and  $\Lambda(1405)$  resonances. A second puzzle is the effective suppression of the expected large spin-orbit interaction required to fit the baryon spectrum.

With the advent of high-duty-factor electron machines (such as ELSA, JLab and MAMI), baryon resonances with higher masses can be produced. A striking result is that the constituent quark model predicts far more states than are actually observed for masses larger than 1.9 GeV. Either these “missing resonances” are not observed, because they couple primarily to channels (for example two-meson- or vector-meson-production) which have not been well-studied experimentally or the quark model is not a complete description and other degrees of freedom might become relevant.

A further complication is that certain resonances might be generated as meson-baryon molecules through channel couplings and threshold effects. A particular well-studied example is the hard-to-model  $\Lambda(1405)$  that has been suggested might be a superposition of two distinct S-matrix poles. Reaction calculations need to be confronted with precision experiments to test such scenarios.

At high energies, charmed baryons can be produced and offer the possibility to study pairs of light quarks in the presence of a heavy quark. The ground-state charmed baryon is now well established and a series of excited states has been reported although determinations of their spin-parities require further investigations. Doubly charmed baryons remain a promise for the future (with the exception of one candidate  $\Xi_{cc}^+$  reported at 3519 MeV by the SELEX experiment at Fermilab, but unconfirmed by BaBar or BELLE).

Recent theoretical studies of baryons have focused largely on LQCD and effective models based on hadronic degrees of freedom. In lattice simulations, significant progress has been made in understanding the masses of the ground-state octet and decuplet baryons. The key issues for baryon excitations are finding a suitable basis of operators that allows the various excitations in a given channel to be identified and developing methods to extract the width of these unstable states. Much progress has also been made in describing the spectrum and dynamics of excited baryonic states through coupled-channel studies based on effective hadronic Lagrangians constrained by QCD symmetries. These approaches are still the main tools for analysing the tremendous amount of new data generated at JLab, ELSA, MAMI and SPring-8. Other theoretical approaches to describing baryons include quark-diquark models based on the Bethe-Salpeter equation and the string-theory-motivated AdS/QCD model, describing strong interactions in terms of a dual gravitational theory.

## Physics Perspectives

There is a multitude of evidence showing that the field of hadron spectroscopy is blooming and should pay major dividends in the future.

In particular, the direct formation of charmonium resonances in antiproton-proton annihilation can be studied with PANDA at FAIR and offers superb possibilities for collecting spectroscopic data with unprecedented accuracy. The scanning technique, where the centre-of-mass energy is varied in fine steps, was successfully employed first at CERN and then at Fermilab thanks to the development of stochastic beam cooling. With this method the masses and widths of all charmonium states can be measured with an accuracy that is limited only by the knowledge of the antiproton and proton beam energies and not by the resolution of the detector. Precision data on these states are necessary to improve our understanding of the conventional charmonium system and the underlying forces.

Several of the lowest-mass charmonium hybrids are predicted to have exotic quantum numbers. The exotic nature of such states should be easily established in antiproton-proton annihilations, whereas the standard process of a partial-wave analysis often leaves some

ambiguities in the quantum numbers. In a production experiment, where the particle is usually produced together with a light meson, states with exotic quantum numbers can be reached. In contrast, a formation experiment can only provide access to non-exotic states, although their properties can be determined very accurately by scanning the centre-of-mass energy. Therefore the appearance of a resonance in a production experiment and its absence in a subsequent scan would immediately signal its exotic nature.

Glueballs are perhaps the most interesting unconventional hadrons. As mentioned above, a candidate for the lightest glueball may already have been discovered. However the majority of these states are expected to appear at higher masses, mostly in the region of the charmonium spectrum. Less mixing of these is expected with conventional mesons and hence they may show up as rather narrow states. The structure of a glueball is completely unknown and spectroscopy experiments may indeed be the only way to reveal it. In order to study the spectroscopy of states in this region in enough detail to determine their nature, experiments at a new antiproton facility are required. This should have a very high instantaneous luminosity, exquisite beam momentum resolution and a detector with large angular coverage

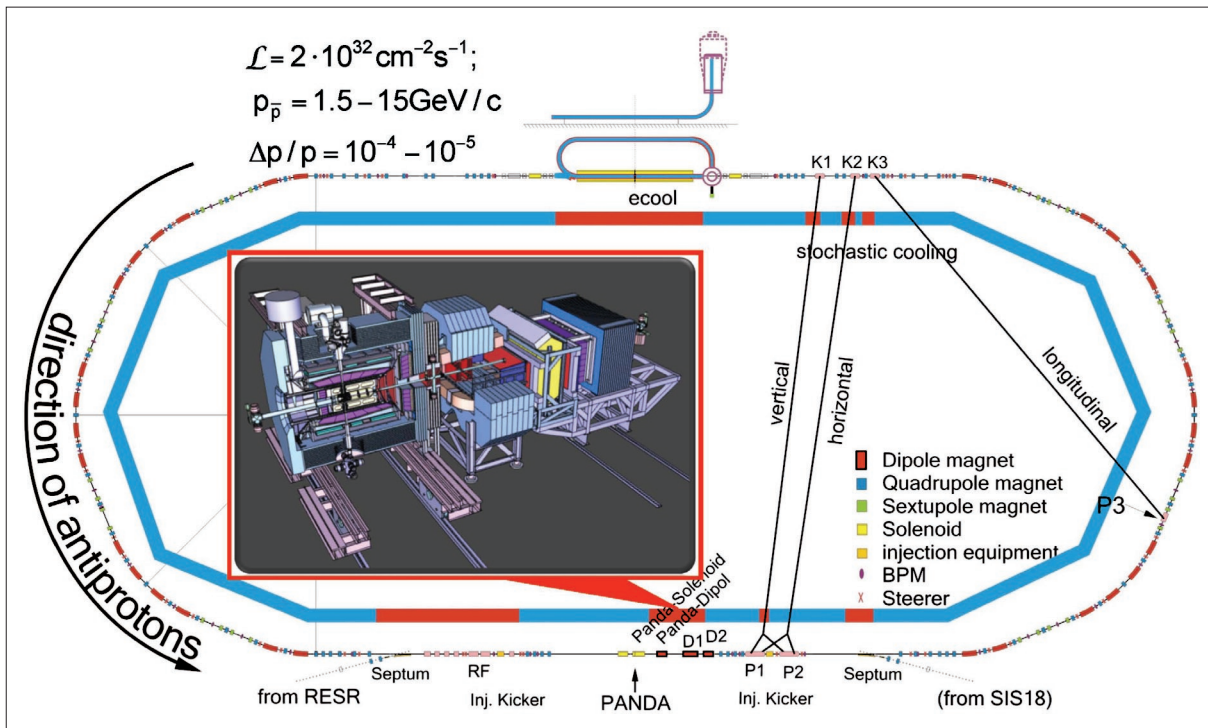

**Figure 7.** The universal PANDA detector located in the HESR storage ring for antiprotons at FAIR. Major physics topics to be addressed include: hadron spectroscopy, hadron structure experiments, hypernuclear physics and antiproton-nucleus interactions.

## 4.1 Hadron Physics

---

and the ability to detect the hadronic decay modes. The FAIR antiproton facility and PANDA detector were designed with such requirements in mind. Since this facility is capable of addressing the hot topics for meson spectroscopy, exotics and glueballs, and also the study of charmed baryons, the highest priority should be to build and develop the HESR accelerator and the PANDA detector with the proposed specifications.

A second important thread in hadron spectroscopy is the study of baryon resonances using electromagnetic excitation. Here, a major technical is the availability of polarised targets at facilities where they can be combined with polarised beams and detectors that can measure recoil polarization. Measurements of complete sets of spin photo-production amplitudes in the region of specific baryon resonances have started at ELSA and JLab and will begin soon at MAMI. This accumulation of new data must be accompanied by intensive analysis efforts. Models developed at Bonn, Giessen, GWU, Jülich, JLab, Mainz, and other places are being continuously improved and extended for this. Multi-channel methods can provide a comprehensive view of very different reactions and offer the best chance of discovering new states.

There is also considerable progress on the horizon for *ab initio* LQCD calculations of excited hadrons. Resonances are much harder than ground states to study in these simulations since they can decay and thus much larger Fock spaces are needed to describe them. The study of excited states on the lattice is therefore a formidable task, which requires small pion masses so that resonances indeed decay, and large volumes, since resonances leave their mark in the volume dependence of energy levels. Furthermore, the effects of channel coupling must be accounted for, which calls for new theoretical tools (such as multi-channel extensions of the Lüscher formalism). All this demands large investments in high-performance computing and in manpower. The potential pay-off is, however, tremendous, both in terms of detailed information on the wave functions of resonances, and also for understanding the emergence of patterns in the spectrum controlled by the symmetries of QCD.

Effective field theories (EFTs) will also have to be developed further to get a deeper understanding of how QCD can give rise to weakly bound states such as hadronic molecules. These theories can provide a systematic framework for clarifying the origin of states such as the  $X(3872)$  and determining the parameters controlling them. This will form a vital complement to LQCD studies, as loosely bound -- and thus very extended -- states are likely to be beyond the reach of lattice methods for a long time.

In addition, EFTs incorporating chiral, isospin and heavy-quark symmetries should be developed beyond leading order to elucidate the inner workings of heavy-light systems. Similarly, unitarisation and coupled-channel approaches need to be refined and applied to as much data as possible from a range of very different processes including both hadron and electromagnetic production.

The interplay between experiment and theory in hadron physics is of particular importance for the field. It has led to much progress already and will continue to play an important role in the future. The success of the new generation of experiments studying the fundamental spectroscopy of hadrons depends critically on the robust information that can be extracted out of the data. These experiments, with unprecedented statistics, excellent resolution and measurements of polarization observables, demand an unrivalled degree of detail in theoretical understanding if new discoveries and insights into the hadron spectrum are to result. A close collaboration between theory and experiment seems therefore mandatory and has in many cases already been established inside the experimental collaborations. Also, large theoretical networks like the “hadron physics theory” in the EU FP6 and “QCDnet” in the FP7 have led to much new and fruitful collaboration.

### European Perspective

As a result of its dedicated accelerators for hadron physics, Europe has taken the leading role in this field. Results from experiments using hadron beams and from others with lepton or photon beams often give complimentary information which is essential for understanding the hadron spectrum. Most of the detector systems at the existing facilities have been upgraded and are now capable of taking data with the necessary precision. The next step forward will require the HESR antiproton facility at FAIR and the PANDA experiment to be completed in a timely fashion and according to specifications. In the meantime, to ensure continuity in this challenging field, it is absolutely necessary that dedicated programmes at ELSA, MAMI and COSY should continue to produce world-class data in their energy domains.

In support of these experimental efforts, European physicists are also playing leading roles in the theoretical aspects of hadron physics. The groups working in the most prominent domains, effective field theories and lattice gauge calculations, are highly respected and their track record of innovative developments should guarantee progress in this field.



## Global Perspective and Efforts

In the USA, JLab will receive a major upgrade in beam energy within the next 4 years. New detectors and beam lines complement this. The GlueX experiment will probe similar physics to PANDA, but in the light-quark sector just below the charm threshold. It is optimized to look for hybrid states with strange quarks. An upgraded CLAS12 experiment will study light baryon spectroscopy at higher masses. In Japan, spectroscopy of strange particles will also be done using the kaon beams at the JPARC facility.

BELLE will continue running after a major upgrade of the accelerator and the detector. The expected increase in data rate by a factor of 100 will allow the possible discovery of new phenomena exploiting the same techniques as currently used but with greatly increased sensitivity. This should not be a competitor for PANDA in the field of precision hadron physics, provided the time scales stay more-or-less as they are. SuperBELLE, coming online 2014-15, will take several years to accumulate the required statistics of several thousand events for a final state to determine its quantum numbers from a partial wave analysis. PANDA will be able to accumulate sufficient data much faster. The inherent problems of being limited by detector resolution or being constrained to a specific decay chain will remain as disadvantages for SuperBELLE compared to an antiproton facility.

The BESIII experiment in China has started data taking and will dominate the traditional spectroscopy of the charmonium states that are accessible at  $e^+e^-$  colliders. The volume of the data it will produce and the quality of the detector make it a major step forward in hadron physics.

Theoretical groups from all over the world have started to work together to address the difficult problems of hadron physics and non-perturbative QCD. Regular meetings are scheduled and common proposals to funding agencies are beginning to appear.

## 4.1.5 Hadronic Interactions

### Recent Achievements and Hot Topics

The interactions between hadrons play a crucial role in shaping our understanding of QCD. They are also at the heart of the second manifestation of strong QCD – the formation of atomic nuclei and other exotic forms of strongly interacting matter. With the advent of EFTs and progress in lattice QCD, supplemented by phenomenological studies and the many high quality data from various laboratories world-wide, the study of hadronic interactions is developing into precision science.

Arguably the most advanced analyses have been performed for interactions between mesons, in particular between pions. Here, combining chiral perturbation theory at two-loop order with dispersive techniques has led to predictions of the S-wave  $\pi\pi$  scattering lengths with the astonishing precision of 2% – truly a benchmark calculation. These scattering lengths are now being tested in various experiments and also by lattice calculations (see Figure 8). It is fascinating to see how pion physics has become a precision laboratory both theoretically and experimentally.

The extension of these studies to the simplest reaction involving strange quarks, elastic  $\pi K$  scattering in the threshold region, has not yet achieved such precision. On the theoretical side, loops including the heavier strange quark have more pronounced effects, and on the experimental side, the database is not yet sufficient. Furthermore, lattice calculations have not yet reached an accuracy comparable to that of the  $\pi\pi$  case. However,

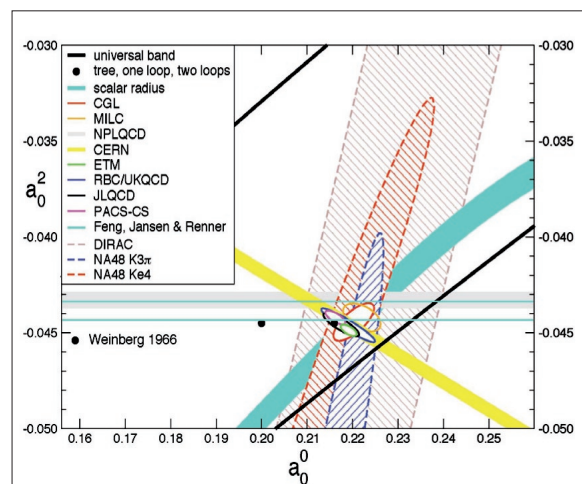

Figure 8. Experimental and theoretical results for the S-wave  $\pi\pi$  scattering lengths.

## 4.1 Hadron Physics

heavy-meson decays, such as  $D \rightarrow K\pi\pi$  at FOCUS, can provide access to the S-wave  $\pi K$  scattering lengths. These could thus lead to detailed tests of chiral QCD dynamics with strange quarks.

Similarly, there are other indications from both EFTs and lattice simulations that the strange quark may not be light enough to be treated using the same tools as work well for up and down quarks. Using unitarisation methods, one can extend the range of applicability of these methods for S-wave meson-meson scattering to higher energies, at the expense of some of the theoretical rigor. This will permit, in particular, studies of aspects of the scalar sector of QCD, including the suppression of the strange-quark condensate, the dynamics of the OZI rule violation, and the possible mixing of scalar mesons with glueballs. There is also rich experimental information from various laboratories on the decays of D and B mesons into light-quark multi-meson states. When tackled with appropriate theoretical tools, these should allow a variety of precision studies of meson-meson interactions.

There has also been remarkable progress in experimental and theoretical studies of pion-nucleon and other meson-baryon interactions. These interactions can provide a variety of tests of chiral and flavour SU(3) symmetries, related mostly to the determination of the S-wave scattering lengths. Moreover, these fundamental interactions are important as input into the description of the strong force that binds nucleons and hyperons in nuclei and hypernuclei. Calculations of pion-nucleon scattering in chiral perturbation theory and of pionic hydrogen and deuterium have now matched the superb precision of the decade-long experiments on these systems at PSI, see Figure 9.

The situation is much less clear for the interactions of (anti)kaons with nucleons, which play a similarly important role in strangeness nuclear physics. The extraction of the scattering lengths from kaonic hydrogen measured at DAΦNE is at odds with the values obtained from the analysis of older scattering data. This poses a fundamental puzzle that requires further theoretical investigations and the measurement of kaonic hydrogen and deuterium with SIDDHARTA. It is also reflected in on-going discussions about the possible existence of deeply bound kaonic clusters, states in which an antikaon ( $K^-$ ) is strongly bound to several nucleons. Experiments performed with FINUDA at DAΦNE on  $K^-$  stopping in light nuclei lead to various correlated hadron pairs that might be indicative of such clustering phenomena. Other evidence for such exotic compounds comes from the reanalysis of older DISTO data. In this field, there is a particularly strong collaboration between experimentalists and theorists.

Outstanding progress has been made in the derivation of nuclear forces from chiral EFT. Although there is still

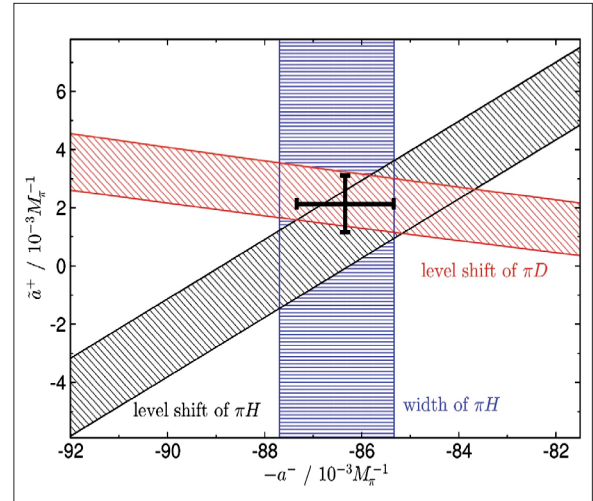

**Figure 9.** Determination of the  $\pi N$  scattering lengths from pionic hydrogen and deuterium.

an ongoing debate about the renormalisation of these forces and the resulting expansion scheme, in practice very successful potentials have been constructed using Weinberg's original scheme at next-to-next-to-next-to-leading order in the chiral expansion. These potentials provide an accurate representation of two-body scattering data and are currently being used as input to *ab initio* nuclear structure calculations. It should also be mentioned that first lattice calculations can reproduce the main trends of the nuclear interaction, namely the intermediate-range attraction and the short range-repulsion.

In addition, EFT provides a consistent framework for the construction of three- and four-body interactions and of effective electroweak current operators. Calculations of light nuclei show that these three-body forces are essential for an accurate description of their binding energies and are intimately related to threshold pion production in proton-proton collisions, which are currently being studied in experiments at COSY. An appropriately tailored EFT has been developed and it demonstrates that a consistent picture can link data on pion production, on nucleon-deuteron scattering, and on tritium beta-decay. A particular achievement is the extraction of the strong contribution to the proton-neutron mass difference from the isospin-violating forward-backward asymmetry of  $np \rightarrow d\pi^0$ , which had been measured earlier at TRIUMF. This shows that we now have the means to extract fundamental QCD parameters from interactions involving few nucleons and pions.

These techniques are now being extended to hyperon-nucleon and hyperon-hyperon interactions.

The longest-range parts of these forces arise from pion exchange and so can be calculated from the same chiral EFT as used for NN interactions. Here the smaller scattering lengths and weaker pion-hyperon couplings mean that Weinberg's expansion scheme is appropriate. However, there is a clear need for a larger and better database, as current analyses are not able to pin down the sizes of the singlet and triplet scattering lengths. Here too, proton-proton collisions with strangeness in the final state, and measurements of polarization observables can offer another means for determining these fundamental parameters. Experiments on processes such as  $pp \rightarrow pK\Lambda$  are now under way at COSY.

Hypernuclei, nuclear systems with one or more bound hyperons, can provide an alternative route to learning about the hyperon-nucleon interaction. There has been considerable experimental progress in the  $\gamma$ -spectroscopy of their low-lying excited states, at KEK, JLab and Frascati. This has led, for example, to the first determination of the spin-spin terms in the YN interaction. Hypernuclei also offer a unique possibility to study the non-mesonic weak decays  $\Lambda N \rightarrow NN$ , due to the Pauli principle hindering the pionic decay modes. Such processes can provide the primary means of exploring the strangeness-changing weak interactions between baryons.

Work on EFTs has also led to the important insight that few-body systems with short-range interactions and a large scattering length display *universal* features that do not depend on the details of their structure or their interactions at short distances. In the two-body sector, these universal properties are familiar, arising from the leading terms of the effective-range expansion. They include, for instance, the relation between the binding energy and depend the scattering. In the three-body sector, universality leads to the Efimov effect – the accumulation below threshold of bound states of a three-body system when the two-body bound states are located exactly at the dissociation threshold – and a log-periodic dependence of scattering observables on the energy and the scattering length. These features have been observed in ultracold atomic systems but are also expected to appear in few-nucleon systems, halo nuclei, and even in hadron physics. Here, for example, the  $X(3872)$  is a very loosely bound  $D^{*0}\bar{D}^0$  lying within half an MeV of the  $D^{*0}\bar{D}^0$  threshold. Such a shallow state should display universal features, which can be tested by studying  $D^0 X(3872)$  scattering in final-state interactions of  $B_c$  decays. These universal properties are embodied within the framework of EFTs, making these the best tool for such calculations. Universality provides fascinating links to other fields of physics, spanning energies from meV to TeV, and such connections should be made even stronger in the future.

Another area that has received much attention is the so-called “medium modification” of hadron properties in hot or dense matter. Changes to the vector mesons' spectral functions (mass and width) have been proposed for two decades as possible signals of modifications of the QCD condensates in the nuclear medium. Reduced vector-meson masses have been predicted for vector mesons and searched for over the years in several experiments, making use of different energy regimes and collision systems, to cover a range of densities and temperatures. As of today, experiments have been conducted, albeit with rather low statistics, at GSI, KEK, JLab, BNL, and CERN. None of the published results gives a clear and unambiguous signal of non-trivial in-medium effects. Moreover, since the experiments cover different phase space regions, their results are not easily compared. Nonetheless, they do point towards a sizeable broadening of the vector states in matter.

## Physics Perspectives

There are very bright prospects for studies of hadronic interactions in both the short and long term. In particular, the J-PARC and FAIR facilities should produce abundant data on hadronic systems with strange and charm as well as light quarks. On the theoretical side, LQCD and EFT methods are now capable of dealing with the multi-scale problems that necessarily arise in such systems. With the new area of charm-quark nuclear physics, it will also be able to learn about the interplay of and transition from non-perturbative to perturbative QCD dynamics.

The upcoming huge body of data for  $J/\psi$  and  $\psi'$  decays from the BES-III experiment at BEPCII will offer multiple opportunities to further investigate fundamental properties of QCD encoded in the decay and final-state dynamics. For example, it has recently been shown that the light quark mass difference  $m_u - m_d$  can be extracted from a combined analysis of  $\psi' \rightarrow h_c \pi^0$  and  $\eta'_{c0} \rightarrow \chi_{c0} \pi^0$  decays, the latter being measurable with PANDA at FAIR. Other tests are related to chiral dynamics with strange quarks and  $SU(3)_{\text{flavour}}$  breaking. In this field there is a close collaboration between theory and experiment with the intended goal to maximize the physics output from the upcoming premier hadron physics facility FAIR. In Europe, there will be dedicated chiral perturbation theory tests, tests of the discrete symmetries C,P,T and the search for physics beyond the Standard Model in dedicated  $\eta$  and  $\eta'$  decay studies at MAMI, ELSA and COSY.

Lattice QCD calculations are now starting to include the so-called disconnected contributions, which will allow for precise calculations of the isospin zero (1/2)  $\pi\pi$  ( $\pi K$ ) scattering lengths employing Lüscher-type formulae. Similarly, a systematic analysis of all meson-baryon and

## 4.1 Hadron Physics

---

baryon-baryon scattering lengths is in reach based on extension of the Lüscher approach to the multi-channel case.

This will allow for many stringent tests of the chiral SU(3) dynamics of QCD and will also bring new insight into the strangeness content of the nucleon. In particular, two central questions will then be answered: 1) *is the strange quark really light?* and 2) *is the strange quark condensate suppressed compared to its non-strange cousin?* The European lattice community plays a very important role in this field and will continue to do so in the future if appropriate high performance computing resources are secured.

High-resolution  $\gamma$ -spectroscopy of hyper-nuclei at MAMI-C and JLab will shed further insight into the fundamental YN interactions. The study of double hyper-nuclei at J-PARC and in the future with PANDA will allow for the first time to experimentally study the hyperon-hyperon interaction – provided that such double hyper-nuclei can be produced abundantly and identified unambiguously. EFT methods can then be used for a systematic and consistent analysis of NN, YN and YY scattering. This would be a tremendous step forward in our understanding of baryonic interactions. In this context, future experiments with AMADEUS and FOPI and at J-PARC will shed further light on the puzzling issue of the deeply bound kaonic clusters.

Pion production experiments in isospin-violating proton-proton and deuteron-deuteron at COSY including polarization in the initial states have to be vigorously pursued to gain further insight into the low-energy structure of QCD, especially leading to novel determinations of the light quark mass ratio. This goes hand in hand with the necessary developments of EFTs that can handle the fairly large momentum transfers characterizing such reactions. In this area, new data are solely produced with COSY and European theoreticians play a leading role.

With PANDA at the horizon, there are bright prospects for investigating the effects of open and hidden charm states with and in nuclei. The possible binding of  $J/\psi$  in nuclei is of theoretical interest since it is related to gluonic interactions and the distribution of gluons in nuclei. Experimentally, quarkonia are considered as a sensitive probe of hadronic matter under extreme conditions. This shows again the intimate interplay between hadronic physics and the studies of hadronic matter as probed in ultrarelativistic collisions like at RHIC and with ALICE at CERN and in the future with CBM at FAIR. The whole European hadron physics community is preparing for FAIR, as testified by the various experimental and theoretical hadron physics networks that centre on the future physics at FAIR. However, there is a concern that, considering the long time until the start of the FAIR

hadron physics programme, a lack of opportunity for performing hadron physics experiments might develop in the interim.

In the field of hadronic interactions, there has always been a close collaboration between experimentalists and theorists, which is also reflected in the various EU networks such as LEANNIS and SPHERE. This successful interaction will have to continue if significant progress is to be made in this challenging field.

### European Perspective

With FAIR at the horizon, a large variety of worldwide unique interaction studies including charm quarks will become possible – as discussed before – connecting in particular the fields of hadron and nuclear physics by investigating the properties of charmed mesons and baryons and their interaction with the nuclear medium.

In the field of hyper-nuclear physics, there is a bright future in Europe. At MAMI-C, a programme of hyper-nuclear spectroscopy exploiting the high resolution spectrometers for the study of the  $(e, e'K^+)$  reaction on nuclei has been started, and will nicely complement similar studies at JLab. A pilot experiment on the production of hypernuclei by heavy ions (HyPhi) at GSI was recently approved with special emphasis on the identification of neutron-rich hypernuclei. FOPI will also search for antikaon nuclear clusters. The long-term perspective in this field is very encouraging, since at FAIR,  $\Lambda\Lambda$  hyper-nuclei will be produced in the ground and excited states, allowing for the determination of the  $\Lambda\Lambda$  interaction, which would be a very important result. Further, if the method of producing  $\Lambda\Lambda$  hypernuclei should be extended to also produce  $\Lambda\Lambda\Lambda$  hypernuclei by using  $\Omega^+\Omega^-$  production from antiproton annihilation. No other laboratory in the world has this possibility.

Also the physics programme of COSY will find its natural and more challenging extension in energy at the FAIR-GSI complex. At higher energies the mechanism of exclusive meson production is poorly known and seems a challenging new field, which is possible to be explored with a new generation of hermetic and technologically advanced detectors like PANDA.

The study of in-medium effects can be extended to charmed mesons with PANDA. Antiprotons together with nuclear targets can be used to produce charmed mesons directly inside a nuclear target. Often the appearance of one charmed meson in the detector facilitates the triggering on the second charmed meson to be studied.

On the theoretical side, European groups working in lattice QCD, EFTs and hadron phenomenology will



---

concentrate their efforts and continue to play a leading role – provided sufficient computing resources are made available.

## Global Perspective

The recently inaugurated J-PARC complex of Accelerators at Tokai (Japan) will be the most important laboratory for hypernuclear physics in the next couple of years. Another laboratory that will provide a good wealth of experimental information on hypernuclear spectroscopy is JLab. Several European groups are already involved in experiments there. The European groups participating in these efforts will take the chance to prepare for the long-range programmes with PANDA at FAIR.

### 4.1.6 Recommendations

This report follows the tradition of similar documents written in 2004 (NuPECC Long Range Plan 2004: Perspectives for Nuclear Physics Research in Europe in the Coming Decade and Beyond) and in 1997 (Nuclear Physics in Europe: Highlights and Opportunities). Those earlier reports emphasised the importance of understanding hadronic physics on the basis of the underlying fundamental theory of QCD. Extraordinary progress has been made since the last report. The MAMI C facility in Mainz was successfully installed and new, state-of-the-art detector systems were added to COSY in Jülich and ELSA in Bonn. Probing the nucleon structure by using lepton beams at DESY and CERN yielded important results. Further studies are going on at the COMPASS experiment at CERN. This is complemented by the successful participation of European groups in the Jefferson Laboratory's hadron physics programme. Frascati completed an ambitious programme with the KLOE detector and on hypernuclear physics. The construction of the FAIR facility, which the 2004 report recommended with the highest priority, is taking more time than originally anticipated, because of its international nature, which required lengthy political processes. Theory also progressed significantly in both fields – the simulation of hadron physics on the computer and the development of phenomenological theories on the basis of QCD. Given this progress and promise it holds, three recommendations emerge naturally for the near- and mid-term future and a fourth one for the longer term perspectives of the field.

#### *First recommendation:*

**A speedy construction of the PANDA experiment at FAIR** should be given the highest priority in the near and mid-term future. Surprising new results in recent years point to exciting physics hidden in the strong interaction, waiting to be understood and explored with antiprotons

at FAIR. PANDA has a sophisticated detector system that allows for a broad, diverse physics programme capable of delivering results on hadron spectroscopy, the nucleon's structure, hypernuclei and in-medium modifications of hadrons, which cannot easily be achieved otherwise and therefore represent a major step forward in our understanding of strong interaction physics. As a flagship experiment for hadron physics, PANDA not only enjoys the involvement of most of the hadron physics community in Europe, it also attracts participants from countries outside Europe and thus fulfils the aim of FAIR to be a truly international facility.

#### *Second recommendation:*

**Complete and exploit currently operating facilities** to ensure the best use of the investments made in the past. These running facilities ensure high-quality physics output while FAIR is being constructed. The users come mainly from universities that combine education and research in an ideal fashion. Continuing research at current facilities provides an excellent training environment for the future scientific workforce in Europe. Of course there must be a balance between this recommendation and the funding and work force requirements of the other recommendations listed here.

#### *Third recommendation:*

**Continued support for theory** that aims to understand hadrons in terms of the fundamental degrees of freedom of QCD. Especially important in hadron physics is the close interplay between theory and experiment, which requires strong support for theoretical efforts. The computational (lattice) and phenomenological approaches complement each other and both are required to ensure progress in the future.

#### *Fourth recommendation:*

In the longer term, further detailed studies of the quark-gluon structure of hadrons will require additional dedicated facilities. FAIR offers two options to contribute to this international effort: **the upgrade of the HESR facility to a polarised proton-antiproton-collider or to a polarised electron-proton/ion collider**. Detailed studies for both set-ups should be supported. Gluon density saturation in hadrons will best be investigated at the Electron-Ion Colliders (EICs) planned in the USA or at the LHeC, a possible future accelerator complex using the LHC at CERN.

#### *General remarks:*

Hadron physics is at the interface of elementary particle physics, which deals with pointlike particles in the high-energy limit, and the world around us, composed of richly structured objects that are built out of those fundamental particles. The complex problem of understanding hadrons and ultimately nuclei requires a

## 4.1 Hadron Physics

---

coordinated research effort at highly sophisticated facilities, combined with the education and training of young scientists, and research and development for facilities in the longer term. The results and techniques gained from understanding more complex systems might have far-reaching consequences for other fields of science, where similar difficult problems await solutions. Most of these tasks are accomplished by university groups of different sizes, with university researchers taking the lead in planning and executing the programmes. Therefore it seems crucial not only to invest in new facilities, but also to ensure a healthy infrastructure, both experimental and theoretical, at universities. After all, in most cases universities provide the main showcase for young people and thus play a key role in attracting the new generation of scientists.

## 4. Scientific Themes

---

### 4.2 Phases of Strongly Interacting Matter

**Convener:** Paolo Giubellino (Torino)

Giuseppe Cardella (Catania),  
Francesca Gulminelli (Caen),  
Andrej Kugler (Řež),  
Joakim Nystrand (Bergen),  
Jean-Yves Ollitrault (Saclay),  
Mihai Petrovici (Bucharest),  
Krzysztof Redlich (Wrocław),  
Peter Senger (Darmstadt),  
Raimond Snellings (Amsterdam),  
Johannes Wessels (Münster),  
Urs Wiedemann (Geneva)

**NuPECC Steering Committee Member:**

Jens Jørgen Gaardhøje

**NuPECC Liaison:**

Thomas Peitzmann

## 4.2 Phases of Strongly Interacting Matter

---

### 4.2.1 Introduction

Over the last two decades, the vigorous exploration of the phase diagram of strongly interacting matter has led to tremendous progress in the understanding of the strong interaction.

Converging evidence from heavy ion collisions at various energies is starting to form a coherent picture of how nuclear matter evolves from the nuclear state at zero temperature all the way to a deconfined plasma of quarks and gluons, the state through which our universe evolved shortly after the Big Bang. Due to the joint effort of theory and experiment, a coherent interpretation of the phenomenology of the different regions of the phase diagram of strongly interacting matter has started and is revealing the signs of a phase transition from hadronic matter to a deconfined plasma of quarks and gluons, and of a phase transition from a quantum liquid to a hadron gas.

The study of many-body strongly interacting systems exhibiting collective behaviour is one of the most powerful tools for the advancement of nuclear physics. Collective behaviour frequently reveals qualitatively novel features of the complex system under study. Thermodynamics provides a general framework for the understanding of how properties of macroscopic matter and collective phenomena emerge from the laws governing the microscopic dynamics. The most dramatic example of collective behaviour is the occurrence of phase transitions, accompanied by qualitative changes in matter properties. Experimentally accessible strongly interacting systems exhibit transitions between characteristic phases: a liquid-gas phase transition, a confinement-deconfinement transition and a chiral transition between massive hadrons and almost massless quarks. The strong interaction itself allows for an even richer structure (see also information Box 1).

In most many-body systems the macroscopic conditions influence the microscopic properties. For example, the effective mass of an electron is modified in a semiconductor due to the presence of the crystal structure. For strongly interacting systems such medium modifications are significant, and they appear on a much more fundamental level.

In practice, strongly interacting many-body physics has to be studied in systems where the characteristic length and coherence scales are very small. This requires innovative approaches to studies of collective behaviour. The strong coupling allows for effective multiple interactions of particles even in small systems and on very short time scales, which makes collective behaviour an important characteristic of medium- and high-energy

nuclear reactions. It is by now well established that one can create strongly interacting matter (as opposed to assemblies of independent particles) in accelerator based collision experiments and study its properties. Quantitatively, the properties of an interaction are best reflected on the ‘macroscopic’ level by the equation of state of the matter produced.

Understanding baryonic matter at low energy density constitutes a formidable challenge for strong interaction theory. A microscopic approach to the effective interaction acting among nucleons in the nuclear medium from Lattice QCD is still in its infancy. Therefore, considerable uncertainties still exist in the equation of state of nuclear matter (EoS), particularly concerning its behaviour as a function of the isospin asymmetry. At low density and finite but small temperature of the order of the binding energy of a nucleus, a first order liquid-gas phase transition terminating in a second order critical point is predicted for neutral nuclear matter. For a long time this transition was believed to connect a homogeneous dense liquid phase with a phase of homogeneous diluted gas of neutrons and protons. We now understand that in the diluted disordered phase many-body correlations and clustering play an important role. This opens new perspectives for the understanding of systems where this phase transition occurs in nature, namely in the cores of type II supernovae and in the crust of neutron stars. Properties of such objects can now be closely linked to experiments investigating the liquid-gas phase transition in accelerator based heavy ion collisions.

At low temperatures, quarks and gluons are confined inside colour neutral hadrons. The mass of a hadron is much larger than the sum of the bare masses of its constituents. This is due to the spontaneous breaking of a fundamental symmetry, the chiral symmetry. Such effects completely dominate the low-energy phenomenology of the strong interaction, and make the theoretical treatment extremely difficult. At high temperature, or at high net baryon density, the strong interaction is radically modified. The strong coupling decreases and the confining part of the interaction potential is expected to vanish. In this regime, chiral symmetry should be re-established, which in turn should manifest itself as an observable modification of constituent masses. At very high temperatures, a transition to a system of free and massless quarks and gluons, the quark-gluon plasma (QGP), is expected. This state of matter should have existed in the very early universe, approximately 10  $\mu$ s after the Big Bang, when temperatures were extremely high. The QGP phase transition is probably the only phase transition of the early universe that can be studied experimentally. The QGP should also exist in the core of dense neutron stars, where the net baryon density is very high. The determination of the corresponding equa-



tion of state would therefore determine the behaviour of these astrophysical objects.

Modifications of the strong interaction should already be observable around, i.e., just over or even below, the transition. Properties of bound states, such as the masses of hadrons, are expected to change with increasing temperature or density. Just above the transition the interaction should be weaker, but may still be significant enough to enable bound states to exist. These bound states, however, are not restricted to be our ordinary colourless hadrons. They could be very exotic objects.

Overall, there is an enormously rich phenomenology, intimately related to the extraordinary properties of the strong interaction.

High-energy collisions also constitute a powerful tool to study the distribution of partons (quarks and gluons) inside nucleons and nuclei. When viewed through the ‘microscope lens’ afforded by nuclear collisions at the highest energy, nuclear matter is expected to reveal entirely new features reminiscent of those of glasses. Indeed, the density of gluons inside nucleons is governed by a balance between two effects: 1) the splitting

### Box 1. The phase diagram of nuclear matter

Ordinary substances exist in different phases, such as solid, liquid, gas and plasma, depending on the values of temperature and pressure. By varying the external conditions the substance may undergo a transition from one phase to another. A familiar example is the transition between ice and liquid water at 0 °C at normal atmospheric pressure. The boundaries between the different phases can be drawn as lines in a diagram where the axes are the external conditions. These lines meet at the *triple point* where liquid, solid and vapour coexist. At high temperature and pressure, the distinct phase boundary between liquid and vapour ends in a critical point. Beyond, there is a continuous ‘crossover’ transition between the two phases. The phase boundaries and the critical points represent fundamental landmarks in the phase diagram of each substance and depend on which interaction between the constituents is in play. The phase diagram for water is governed by the electromagnetic interaction. The phase diagram for nuclear matter is governed by the strong interaction.

The figure illustrates the possible phases of nuclear matter and their boundaries in a diagram of temperature (T) versus net baryon density (i.e., the density of baryons minus the density of antibaryons). Cold nuclear matter – as found in normal nuclei – has a net baryon density equal to one. At finite temperature and low density, a transition from liquid to gas occurs, typical for systems characterised by short range repulsion and long range attraction as is the case of nucleons in nuclei. At moderate T and densities above the liquid-gas transition, nucleons are excited to short-lived states (baryonic resonances), which emit mesons in their decay. At higher T, particle-antiparticle pairs (including baryon and antibaryons) are also created. This mixture of baryons, antibaryons and mesons, all strongly interacting particles, is generally called hadronic matter.

At very high temperatures or densities the hadrons ‘melt’, and their fundamental constituents, the quarks

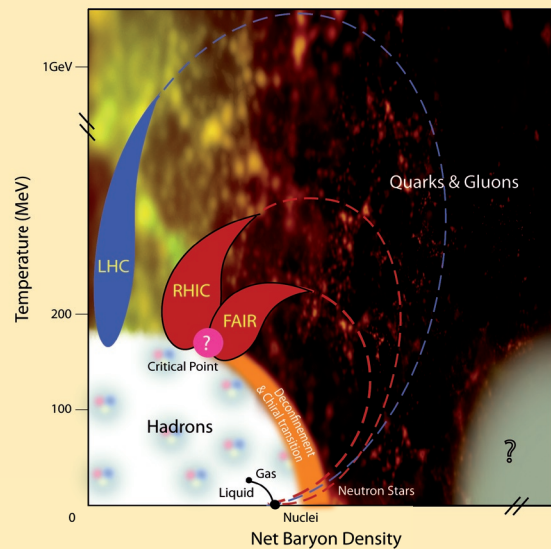

and gluons, form a new phase, the Quark-Gluon-Plasma. For very low net baryon densities where the number of particles and antiparticles are approximately equal, model calculations predict that hadrons dissolve into quarks and gluons above a temperature of about 170 MeV. The inverse process happened in the universe during the first few microseconds after the Big Bang: the quarks and gluons were confined into hadrons. In this region of the phase diagram the transition is expected to be a smooth crossover from partonic to hadronic matter. Model calculations suggest a critical endpoint at relatively large values of the net baryon density. Beyond the critical endpoint, for larger values of net baryon densities (and for lower temperatures), one expects a phase transition from hadronic to partonic matter with a phase coexistence region in between (yellow band). High-density but cold nuclear matter is expected to exist in the core of neutron stars. At very high densities, correlated quark-quark pairs are predicted to form a colour superconductor.

## 4.2 Phases of Strongly Interacting Matter

of gluons into two lower momentum gluons; and 2) the recombination of low momentum gluons into a single high momentum gluon. The gluon density therefore is expected to saturate at a characteristic value. This saturated gluon matter can be regarded as a state representing the classical field limit of the strong interactions.

In summary, the investigation of the phases of strongly interacting matter addresses some of the most important open questions of fundamental physics today. These include:

- What are the fundamental properties of matter interacting via the strong interaction as a function of temperature and density?
- What are the microscopic mechanisms responsible for the properties of high density strongly interacting matter?
- How do hadrons acquire mass?
- How is mass modified by the medium it moves in?
- What is the structure of nuclei when observed at the smallest scales, i.e., with the highest resolution?

We are now on the verge of a significant new revolution in the field, owing to the recent and future availability of very high energy nuclear beams at the Large Hadron Collider (LHC) at CERN and very high intensity beams at the Facility for Antiproton and Ion Research (FAIR) at GSI. These two central facilities, which are at the forefront of the European research arena, will pave the way for the exploration of completely unexplored regimes of the strong interaction. The new generation of powerful state of the art experiments will provide unprecedented resolving power. The LHC will provide an energy increase as compared to the Relativistic Heavy Ion Collider (RHIC) by a factor of almost 30. We note that, in the past, each major boost in energy scale has invariably been accompanied by significant discoveries.

In the subsequent sections of this chapter the fundamental questions which will be addressed in the coming years by theory and experiment will be discussed, based on a short review of some of the most salient accomplishments of the past years. The strategies necessary to ensure that the European Nuclear Physics community will be able to play a leading role in this field will be delineated. In the final section we will summarise the prospects within reach and indicate the efforts that the community considers as its priority.

### 4.2.2 The QCD Phase Diagram

Many of the features of the phase diagram of nuclear matter, relevant for all energy scales, can be understood from the collective properties of the system. In this section we give an overview of some of the general features; in subsequent subsections of this chapter we address more specific probes of the conditions prevailing in the different phases.

The properties of nuclear matter at finite temperature  $T$  and net baryon density (or chemical potential  $\mu_B$ ) are describable from the theory of strong interactions, QCD. The thermal properties and the equation of state (EoS) of nuclear matter are best quantified within Lattice QCD (LQCD), a numerical formulation of the theory on a space-time grid, though analytical methods can provide complementary insights. Experimentally, hot and dense nuclear matter is explored through the study of collisions of heavy ions at ultra-relativistic energies.

**The phase diagram and the EoS from LQCD** – LQCD with dynamical quarks has provided new results on the EoS and on collective phenomena in nuclear matter at finite temperature and chemical potential. Recent results on the equation of state at finite  $T$  and vanishing chemical potential are shown in Figure 1. The energy density increases rapidly in a narrow temperature interval. Such behaviour is generally interpreted as being due to deconfinement, i.e., the liberation of quark and gluon degrees of freedom. The pressure also exhibits

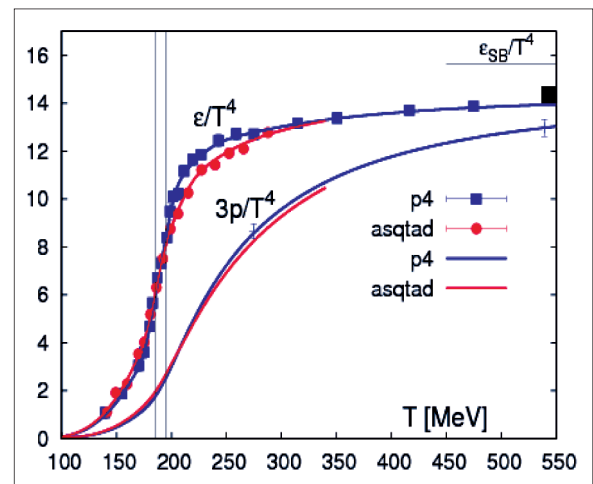

**Figure 1.** Recent LQCD calculation showing the energy density and pressure of nuclear matter as a function of temperature. The calculations were performed in (2+1)-flavour QCD, i.e., they include effects of two light (u, d) quarks and one strange. The predicted QCD transition temperature is in the range 170-190 MeV. (Courtesy of F. Karsch *et al.*)

an increase at the deconfinement temperature, albeit a much more gradual one, which is related to residual interactions between the constituents.

However, confinement is not the only phenomenon responsible for rapid changes in the thermodynamic state variables. The transition related to the breaking of chiral symmetry resulting in the dynamical generation of hadron masses and the appearance of pions as Goldstone bosons plays an essential role. The chiral transition is characterised by a rapid decrease of the quark-antiquark condensate with  $T$  and  $\mu_B$ , which in fact serves as an order parameter of strongly interacting matter. However, the key manifestations of chiral symmetry restoration are its observable consequences for the hadron spectrum. Chiral partners must be degenerate, implying significant modifications of hadronic spectral functions by the medium as the transition is approached. Schematic models and numerical studies with LQCD

have been developed to quantify in-medium modification of physical observables due to the restoration of chiral symmetry.

The chiral condensate has been shown in LQCD to drop rapidly over the same temperature interval where the energy density drops. This suggests that deconfinement and the restoration of approximate chiral symmetry in QCD may be coincidental. However, the exact relation between the deconfinement and chiral phase transition is quantitatively far from established in LQCD.

Recent LQCD calculations constrain the temperature of the chiral and deconfinement transitions at  $\mu_B = 0$  to  $T_c \approx 150 - 170$  MeV. Methods have been developed in LQCD to explore the shift of  $T_c$  with  $\mu_B$  for  $\mu_B < 3T$ . Studies also indicate the possible existence of a critical point (CP) in the phase diagram at finite  $\mu_B$ . They have further led to a quantification of the EoS of nuclear matter at

## Box 2. Broken chiral symmetry and the origin of hadron masses

The origin of the masses of particles is one of the most fundamental questions that we may ask about nature. The visible matter in our universe mainly consists of protons and neutrons, which have a mass of about  $1 \text{ GeV}/c^2$  each. However, within the ‘Standard Model’, the elementary building blocks of protons and neutrons, the quarks and gluons, are massless. Gluons mediate the interaction between the quarks and have, like the photons, no restmass. The quarks, on the other hand, should be massless due to a fundamental property of the strong force, chiral symmetry. In laboratory experiments on Earth, however, we observe non-zero (and very different) quark masses (as shown in the figure below). In the ‘Standard Model’, quarks acquire mass through their interaction with an elementary field filling all space, the so-called Higgs field. The Higgs field breaks chiral symmetry explicitly, generating quark masses. The search for the Higgs particle is one of the main goals of the LHC experiments.

The Higgs mechanism is able to explain the masses of the heavy quarks (green bars in the figure). For the light quarks, which account for the mass of the matter surrounding us, the explicit symmetry breaking is very small, and the resulting small quark masses ( $5 - 10 \text{ MeV}/c^2$ ) are by far insufficient to explain the observed mass of hadrons (for example, the proton mass of  $\approx 1 \text{ GeV}/c^2$ ). In order to explain the mass of a hadron, the vacuum surrounding a quark or gluon inside the hadron must be filled with a strong field of quark-antiquark pairs, called the ‘chiral condensate’.

The interaction of the light quarks with this con-

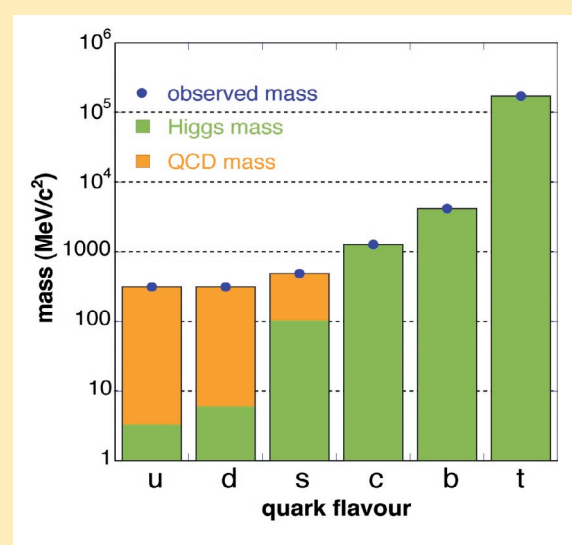

densate breaks chiral symmetry spontaneously, and generates the large quark masses. Increasing the temperature or baryon density of a system, for example through a high-energy nuclear collision, modifies the vacuum. The chiral condensate is diluted and chiral symmetry is partly restored, causing a modification (reduction) of the masses of hadrons. At very high density or temperature the spontaneous breaking of the symmetry should completely disappear and the condensate should vanish. This transition may in fact coincide with the deconfinement transition. The search for signatures of chiral symmetry restoration is of fundamental importance in physics and one central objective of high-energy heavy ion collision experiments.

## 4.2 Phases of Strongly Interacting Matter

the finite  $T$  and baryon density as well as the fluctuations and correlations of relevant physical observables. First results on transport properties of the QGP are also available from recent LQCD studies. However, in order to explore properties of nuclear matter over a broad parameter range at finite density and temperature it is necessary to further develop analytical methods. Studies within the perturbative and non-perturbative approaches based on the Renormalisation Group techniques and the Dyson-Schwinger equations have been very successful in describing collective effects and critical phenomena in dense nuclear matter related with chiral dynamics and deconfinement.

LQCD is the central numerical method, derived from first principles, to describe the properties of hot and dense nuclear matter over a broad parameter range. However, to extract physically relevant predictions from the calculations, extrapolations to the continuum limit have to be made. This requires large-scale computing and access to dedicated supercomputers with petaflop performance.

**Probing the QCD phase diagram in Heavy Ion Collisions** – Experimentally, different regions of the QCD phase diagram can be probed in heavy ion collisions by varying the beam energy of the colliding nuclei. At very high energies, such as those reachable at RHIC and at the LHC, the region of small  $\mu_b$  and large  $T$  is explored, for which reliable LQCD predictions are available. At lower energies, the regime of high  $\mu_b$  is probed at moderate  $T$ , which can only be described with phenomenological models. The first principle LQCD studies and effective models, as well as heavy ion experiments, are essential to characterise the phase structure and the EoS of hot and dense nuclear matter.

The experimental exploration of the phase diagram relies heavily on the applicability of thermodynamics to the system created in heavy ion collisions. Once this is established, phenomenological studies of the bulk properties yield important information on thermal parameters relevant for this exploration. Three important observables to study global properties using hadron distributions in the final state have been established: particle correlations, particle yields and particle spectra.

**Hadron correlations** – Strong evidence for collective expansion in heavy ion collisions is derived from the observation of the anisotropy in particle momentum distributions correlated with the reaction plane. One of the most striking manifestations of anisotropic flow and strong collective expansion is the so-called elliptic flow. The strength of this elliptic flow is characterised by the second Fourier coefficient ( $v_2$ ) of the azimuthal momentum-space anisotropy.

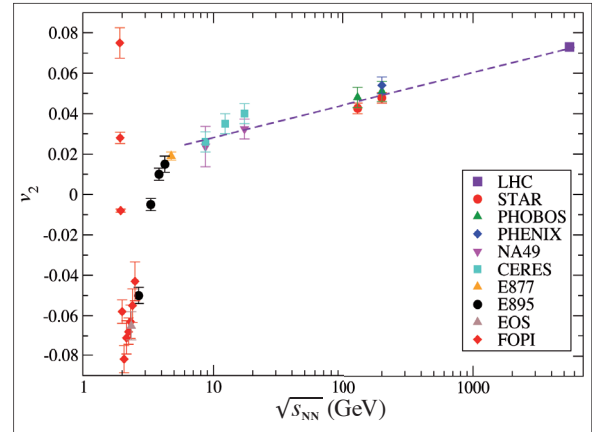

**Figure 2.** Elliptic flow  $v_2$  at mid-rapidity and integrated over transverse momentum. Experimental data are extrapolated to LHC energies. (Courtesy of N. Borghini *et al.*)

Figure 2 shows the measured dependence of  $v_2$  on the centre-of-mass energy. At low energies ( $E_{CM} < 1.5$  GeV)  $v_2$  is positive reflecting the angular momentum conservation of di-nuclear systems, which leads to a preferential emission in plane. With increasing energy the sign changes to negative and  $v_2$  reaches its lowest value at an energy of about 2 GeV reflecting particle emission from the strongly compressed matter in the centre of the collision that is shadowed by the passing spectator nucleons. This causes the produced particles to emerge perpendicularly to the reaction plane leading to a negative value of  $v_2$  (squeeze-out). At these energies the elliptic flow is very sensitive to the nuclear compressibility, i.e., the EoS. Above this, energy  $v_2$  rises, eventually becoming positive again. At AGS, SPS and RHIC energies the timescale for spectator nucleons to pass the created hot and dense system becomes much shorter than the characteristic time for the build-up of the transverse flow. At these energies the elliptic flow becomes in plane again (positive  $v_2$ ). The magnitude of  $v_2$ , above ( $E_{CM} = 10$  GeV), is directly proportional to the initial spatial anisotropy and the interactions among the constituents. The large elliptic flow observed indicates a high level of equilibration at a relatively early stage of the collision. Comparison of RHIC data to hydrodynamical models suggests that equilibration occurs early in the collision history and at the partonic level. Extrapolation to LHC energies suggests very large values of the flow and correspondingly large sensitivity to the initial conditions.

**Hadron yields** – Integrated yields of different hadrons provide information on the medium properties. A detailed analysis of heavy ion data from SIS(GSI) to RHIC(BNL) energies has shown that relative yields of most hadrons



can be described with statistical hadronisation models using only two global parameters: the chemical freeze-out temperature and the baryon-chemical potential. While this observation is striking, it is only necessary but not sufficient evidence for the thermal origin of particle production. However, the indication of early equilibration from elliptic flow measurements makes a thermal description the most plausible one, in particular at high energies beyond SPS. However, measured yields at lower energies are also consistent with a thermal picture. The thermal freeze-out parameters obtained from statistical model fits to data at different energies are shown in Figure 3. All data points approximately follow a curve (solid line) corresponding to a value of the energy per particle in the system of about 1 GeV. In addition, the chemical freeze-out temperatures, for values of the baryon-chemical potential  $< 400$  MeV, agree well with the phase boundary predicted by LQCD. This observation suggests that the particles detected in heavy ion collisions at high energies originate from the hadronising QGP. At centre-of-mass energies near 10 GeV, where the freeze-out approximately decouples from the LQCD transition line, interesting properties of different observables have been found.

Similarly, pronounced maxima are observed in the individual yield ratios of  $K^+/\pi^+$ ,  $\Lambda/\pi$  and  $\Xi/\pi$ . In addition, data show that near this energy the volume obtained from Hanbury-Brown and Twiss correlations exhibits a

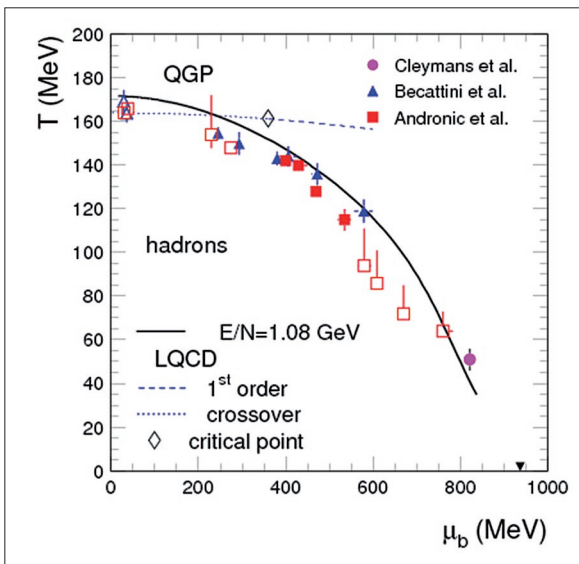

**Figure 3.** Value of temperature and baryon chemical potential obtained from statistical model fits to yields of different hadrons produced in heavy ion collisions over a broad span of beam energies. Note that for low baryon chemical potential values the experimental values are close to the phase transition region predicted by Lattice QCD.

minimum and the system passes from baryon to meson dominance.

Recently, it was conjectured that the above features of hadron production observed in nuclear collisions can be explained by the existence of three forms of matter: Hadronic Matter, Quarkyonic Matter and a Quark-Gluon Plasma which meet at a ‘triple point’ in the QCD phase diagram located at the centre-of-mass energy near 10 GeV.

Figure 4 shows the excitation function of the ratio of strange to non-strange hadrons, as a function of centre-of-mass energy. This excitation function shows a maximum around 10 GeV.

**Hadron spectra** – Hadron spectra provide complementary information on the medium evolution. The shape of the spectra of most hadrons at low transverse momentum is consistent with thermal emission of a collectively expanding source. While the shape alone does not demand a thermal description, the evidence from elliptic flow and the consistency with the hadron abundances make an interpretation of spectra in terms of models inspired by hydrodynamics meaningful.

The particle yield as a function of transverse momentum reveals the properties of the system at the kinetic freeze-out, where interactions of hadrons cease. In the simplified version of such models hadron spectra can be

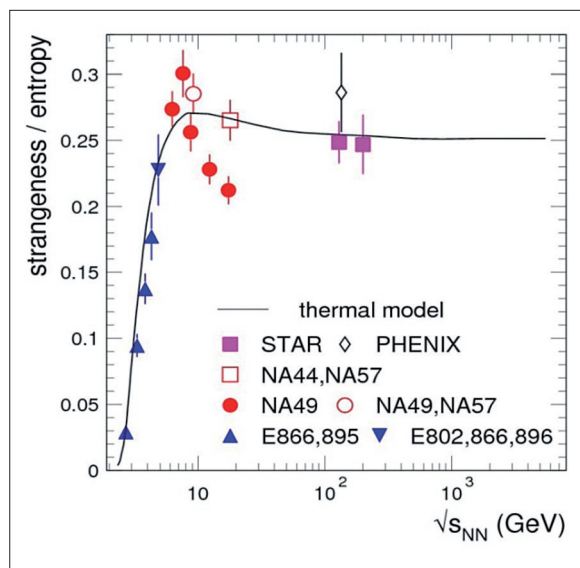

**Figure 4.** Energy dependence of the strangeness to entropy ratio quantified by measured yields of all strange to non-strange hadrons in heavy ion collisions. (Courtesy of A. Andronic *et al.*)

## 4.2 Phases of Strongly Interacting Matter

---

effectively characterised by two parameters: the kinetic freeze-out temperature  $T_k$  and the average transverse flow velocity  $v_t$ .

A detailed analysis of particle spectra in heavy ion collisions has shown that at a given collision energy there is a common set of parameters  $(T_k, v_t)$ , which describes measured low-momentum spectra of most hadrons simultaneously. The parameters indicate collective radial expansion, which increases with the collision energy. Deviations from this behaviour, which are observed for particular hadron species at some collision energies, can be explained by, e.g., smaller hadronic cross-sections or in-medium modifications.

The three observables together sketch a consistent picture of the dynamics of the matter created in heavy ion collisions describing the low-momentum properties of hadron distributions. In heavy ion collisions at very high energies the created system exhibits equilibrium features which are already established in the very early stage when the system is still in a partonic (e.g., with quark and gluon degrees of freedom) phase. It attains a collective expansion velocity driven by pressure with anisotropies of the initial state being reflected in the measured particle momentum distributions. The system undergoes first chemical and then kinetic freeze-out, which appears at a lower temperature due to a larger elastic cross-section of hadrons. At the SPS and higher energies the chemical freeze-out happens near the QCD phase boundary, suggesting that particles originate from a hadronising QGP.

### 4.2.3 Strongly Interacting Matter in the Nucleonic Regime

A quantitative understanding of the properties of nuclear matter in the nucleonic regime requires a precise description of the effective interaction at work in nuclear matter. In turn this is uniquely linked to the Equation of State (EoS). In particular, the determination of the incompressibility of symmetric nuclear matter close to saturation density (the density at which nucleons begin to touch) has been a longstanding challenge in the field.

The functional form of the EoS cannot be directly deduced from data. However, the different energy functionals can be implemented in transport equations and converted to transport model predictions that can be measured in nucleus-nucleus collisions. The combined measurements of collective flow of  $K^+$  mesons, protons and light fragments in the energy range of about 0.05 – 1.5 A GeV have now constrained the incompressibility modulus at saturation,  $\rho_0 \approx 0.17 \text{ fm}^{-3}$ , to values of  $K = 170 - 250 \text{ MeV}$ . The transport calculations used to interpret the data need to involve momentum-dependent interactions as well as in-medium kaon potentials to describe the data properly.

The incompressibility at higher density is still very poorly known and needs to be addressed in future experiments at relativistic energies, where degrees of freedom different from protons and neutrons become important.

#### Equation of State, symmetric nuclear matter EoS –

Past investigations have concentrated primarily on the incompressibility of the symmetric nuclear matter EoS, leaving the isovector dependence, i.e., the dependence on the difference between neutron and proton densities, largely unexplored. This term, called the symmetry energy, plays a critical role in neutron stars where it is responsible for most of the pressure supporting the star at densities less than twice the saturation density. It has implications for the density profile of neutron stars, the mass boundary between neutron stars and black holes, and neutron star cooling. Predictions for the total energy released during a type II supernova collapse and its time dependence are also strongly influenced by the symmetry term. Last but not least, the symmetry energy plays a key role in the dynamics of heavy ion collisions, the process used to produce new forms of matter in the laboratory. Thus, the determination of symmetry energy from low to high densities is a strong motivation for significant experimental and theoretical efforts.

### Box 3. Heavy ion fragmentation and liquid-gas phase transition

Like boiling water, the nuclear liquid-gas phase transition is a discontinuous transition. This means that characteristic properties of the matter are expected to show a sudden variation at the transition. This is manifested by the values taken by a suitable collective observable, the so-called order parameter.

Theoretical calculations (see figure, right panel) show that the size of the heaviest cluster  $A_{\text{big}}$  produced in each fragmentation event is an order parameter. Its distribution has a bimodal (doubly peaked) behaviour at the transition; the two peaks represent the two coexisting phases. The excitation energy jump between the two phases corresponds to the latent heat of the transition. Conversely in the absence of a transition (see figure, left panel) the order parameter distribution does not present any bimodal structure.

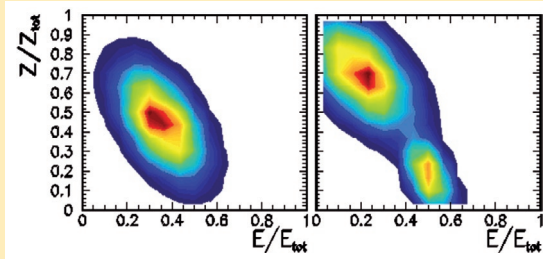

**Symmetry energy below saturation** – The behaviour of symmetry energy below nuclear matter saturation cannot be extrapolated from the theory or experimental data for normal nuclear matter, because of the dominance of many body correlations and clustering at low density. It is therefore essential to extract information on this quantity from experimental situations where clusters are actually formed, namely in multi-fragmentation reactions which, according to transport calculations, typically explore a density domain between one-third of saturation and saturation.

The isovector properties of the EoS govern the isospin transport, which lead to isospin equilibration (transfer to bound states) and emission of fragments (transfer to continuum states). Isospin equilibration is measured by the global isospin content of the quasi-projectile in peripheral reactions, while isospin emission is measured by the isospin content of mid-rapidity fragments and pre-equilibrium particles.

Heavy ion experiments with stable beams have in the very recent past provided important new constraints on this fundamental quantity (Figure 5). These

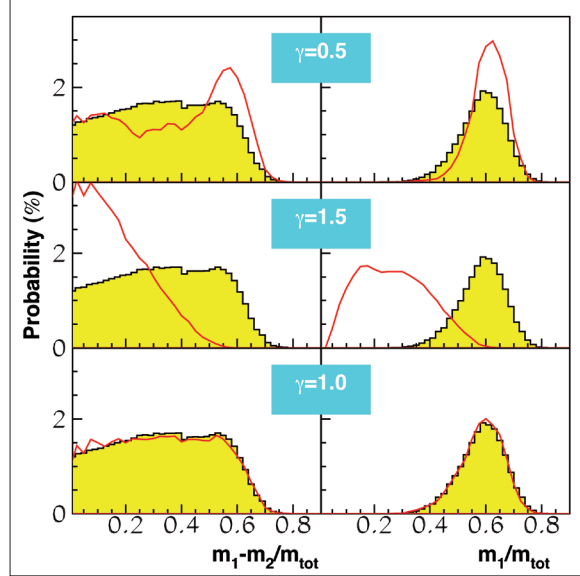

**Figure 5.** Determination of the energy  $c_{\text{sym}} \propto \rho^{\gamma}$  from the comparison of the size distributions of the heaviest fragments detected in the collisions  $^{40}\text{Ca}+^{48}\text{Ca}$  at 25 MeV per nucleon, to transport calculations. (Courtesy of F. Amorini *et al.*)

constraints tend to agree with the complementary information extracted from the pygmy resonances, giant modes, dynamic dipole excitation and mass measurements, which are discussed in a separate subsection. In particular, important constraints on the  $g$  coefficient governing the density dependence of the symmetry energy  $c_{\text{sym}} \propto \rho^{\gamma}$  have been identified and the present research is focused on the determination and control of the systematic errors.

**Symmetry energy above saturation** – Almost no experimental information is available for the symmetry energy at super-saturation densities. Several potentially useful observables in collisions between isospin asymmetric nuclei have been identified in dedicated transport calculations, including neutron and proton collective flow, ratios of neutron/proton,  $\pi^+/\pi^-$ ,  $K^+/K^0$ , and  $\Sigma^-/\Sigma^+$ . Constraining the density dependence of the symmetry energy in this regime constitutes a formidable challenge for future experiments at relativistic energies.

**The neutron-proton effective mass splitting** – The difference in the effective mass of protons and neutrons is intimately connected to the momentum dependence of the EoS. Predictions for this quantity differ widely in different theoretical approaches, even at normal density. Experimental constraints on the mass splitting provide important input for nuclear structure, and for the structure of neutron star crusts. The difference between the

## 4.2 Phases of Strongly Interacting Matter

effective masses determines the kinetic observables established in the entrance channel, i.e., the transverse momentum distributions of pre-equilibrium particles and collective flow. They will need to be explored in detail in the near future.

**The liquid-gas phase transition** – Nuclear matter is now known to undergo a transition from its liquid ground state to a gaseous state of nucleons at a temperature of few MeV. Impressive progress has been achieved in the past years towards the characterisation of this phase transition. This progress is largely based on the exploitation of data analysed with second-generation 4<sub>π</sub> detectors like INDRA and CHIMERA and other more specialised detector arrays. In particular, approximate values for the temperature, energy and density of this phase change have been established. Studying the transition with finite nuclei has the extra advantage of also revealing the thermodynamic anomalies, which should be associated with first order phase transitions of any finite system (negative heat capacity, bimodal distributions).

A negative heat capacity from anomalously large kinetic energy fluctuations was observed in the past, but the signal has turned out to be inconclusive. This is mainly attributed to uncertainties connected to the evaluation of the effect of secondary decays. Very recently bimodal distributions of the order parameter have been measured for the Au+Au system using different experimental setups (Figure 6).

The high  $Z_1$  peak corresponds to evaporation events, while the low  $Z_1$  peak is associated with the expected opening of the multi-fragmentation channel. The presence of a minimum between the two is non-trivial, and it is interpreted as a signature of the finite system counterpart of a first order phase transition.

For the first time, these data have allowed a determination of the latent heat of the transition. Experimentally, this is revealed by the difference between the average excitation energy associated with the two observed peaks.

**Phase transition in asymmetric matter** – To identify the transition line in the global phase diagram and explore its isotopic dependence, it is necessary to carry out multi-fragmentation experiments with exotic beams (i.e., beams of extreme  $N/Z$  ratios). First exploratory results on the isotopic dependence of the nuclear caloric curve have been obtained with the ALADiN experimental setup at GSI (Figure 7). Temperatures appear to be very slightly influenced by the isospin degree of freedom within the valley of stability.

In the next-generation experiments, the onset of fragmentation will be established using the techniques that have been developed for stable beams. The change of the fragmentation threshold with the source charge and asymmetry will provide access to the charge and asymmetry dependence of level densities and limiting temperatures. Experiments exploring the asymmetry in a yet inaccessible region through the study of scaling violations of fragment observables may reveal new physics. The study of multi-fragmentation with exotic beams has important astrophysical consequences. Indeed, multi-fragmentation is a unique laboratory for the formation of inhomogeneous structures due to the interplay between nuclear and Coulomb effects. Such structures have to be correctly modelled for the supernova explosion process and the cooling dynamics of proto-neutron stars. Moreover, the electron capture rate on nuclei and/or free protons in pre-supernova explosions is especially sensitive to the symmetry energy at

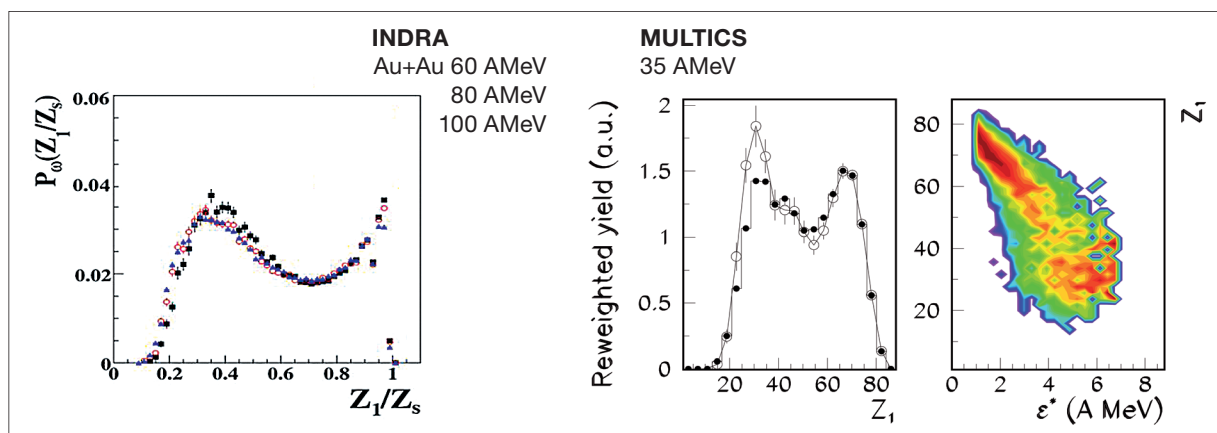

**Figure 6.** Distribution of the heaviest fragment (normalised to the source size in the left panel) in the fragmentation of a  $^{197}\text{Au}$  nucleus, clearly exhibiting a bimodality signal. Results from different beam energies and experimental setups and data analysis techniques are shown to be fully compatible. (Courtesy of E. Bonnet, M. D'agostino *et al.*)



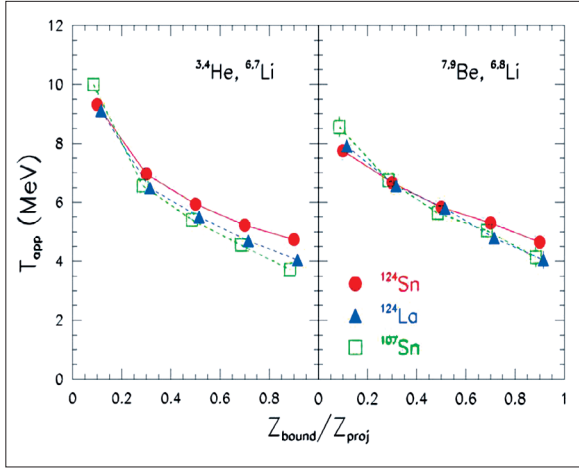

**Figure 7.** Isotopic dependence of the break-up temperature extracted experimentally from the relative population of isotopes, the so-called isotopic thermometer. (Courtesy of C. Sfontini *et al.*)

finite temperatures. This information can be extracted from isotopic ratios of light particles and fragments from carefully selected space-time emission regions. These regions will be separated using collective observables and imaging techniques, which are already currently developed in the field.

**Isospin fractionation** – The comparison of data with different asymmetries and similar centrality will also allow the different isotopic composition of coexisting phases to be quantified for isospin asymmetric systems, a phenomenon known as isospin fractionation. Up to now this has only been studied for stable systems. Fractionation is a generic feature of phase separation in multi-component systems. In particular, since an increased fractionation is expected, if fragmentation occurs out of equilibrium, a quantitative study of fractionation will elucidate the role of spinodal instabilities in the as yet unclear mechanism of fragment production.

**Modelling the nucleonic regime** – At the theoretical level, extraordinary progress has been achieved in the past years connected to microscopic calculations for nuclear matter at sub-saturation densities, where correlations and clustering of nucleons into fragments dominate. The extension of these calculations to neutron rich systems will be available in the next few years and will need to be confronted with experimental data. New progress in the studies of dynamical non-relativistic transport theories (TDHF and its extension) will be essential for the interpretation of transport observables. Such calculations are required to quantitatively extract the EoS from experimental data, and should also be strongly encouraged.

**Requirements** – The availability of intermediate energy beams up to several hundreds of MeV per nucleon is essential to test regions of different baryon (isoscalar) and isospin (isovector) density during the collision process. For this reason it is important to complete the superFRS programme at FAIR, and to begin the construction of adequate post-accelerators at SPIRAL2 and possibly SPES, steps towards a future EURISOL facility.

To extract the isovector part, one needs to measure differential quantities (i.e., ratios of proton-neutron, or  $^3\text{He}$ - $^3\text{H}$ ). To minimise theoretical as well as experimental uncertainties, it is important to compare systems of similar size but markedly different  $N/Z$ , since in this case the difference between the predictions of different EoS is amplified.

Measuring collective observables necessitates full event reconstruction with low thresholds as well as  $A$  and  $Z$  identification for heavy elements, as in the FAZIA project.

#### 4.2.4 Exploring the QCD Phase Diagram at Large Baryon-Chemical Potentials

One of the goals of future heavy ion collision experiments at relativistic beam energies is the precise scanning of the QCD phase diagram in the region of high net-baryon densities.

Such experiments address fundamental physics questions: What are the properties of very dense nuclear matter? Is there a first order phase transition between hadronic and partonic matter? Is there a critical or a triple point and, if yes, where are these points located? Is there a chiral phase transition and, if yes, does it coincide with the deconfinement phase transition? Are there new QCD phases such as ‘quarkyonic’ matter?

As mentioned in the previous chapter, the observation of a limiting chemical freeze-out temperature of about 160 MeV indicates a change in the degrees-of-freedom of the fireball. Such temperatures may be reached using heavy ion collisions between beams with energies of about 30 A GeV on fixed targets. At the same energy, maxima in the excitation functions of the ratio of strange-to-nonstrange particles have been found (see previous chapter). This observation has been interpreted as a signature for a transition from baryon to meson dominated matter, but is still controversial. In particular, the strangeness-to-entropy ratio measured by NA49 at SPS energies exhibits a sharp structure, which cannot

## 4.2 Phases of Strongly Interacting Matter

---

be described by hadronic models. This disagreement between theoretical estimates and data has caused speculation about the possible onset of deconfinement already at low SPS energies.

A careful beam energy scan will be required to discover structures possibly caused by the deconfinement phase transition and/or the critical endpoint in the QCD phase diagram. In order to obtain a consistent picture, one has to investigate a comprehensive set of observables, and search for a non-monotonous behaviour in their excitation functions. The challenge is to identify signatures of the partonic phase which survive hadronisation. It is obvious that those observables which are generated in the early phase of the collision, and which are not distorted by final-state interactions during the evolution of the fireball, are the most promising candidates in this respect. These observables are discussed below.

**Collective flow** – One of the observables which is sensitive to the initial (anisotropic) fireball shape in coordinate space is elliptic flow. A central question is whether the hadron elliptic flow, although expected to be significantly smaller in magnitude than at RHIC energies, will show features similar to those found at high energy. In particular, whether the flow scales with the number of constituent quarks, thereby suggesting that the effect originates already in the partonic phase. Will this scaling feature disappear below a certain beam energy? The answer to this question requires a beam energy scan of the elliptic flow of pions, kaons, phi-mesons, D-mesons, charmonium, as well as of nucleons, and (multi-) strange hyperons (including the antiparticles). The experimental challenge will be to measure all these particles up to high transverse momenta.

Particles with low hadronic cross sections like  $\Phi$  mesons,  $\Omega$  hyperons and  $J/\psi$  mesons are expected to be particularly sensitive probes of the partonic phase. Indeed, in Pb+Pb collisions at 158 A GeV the inverse slope parameter (or effective temperature) of  $\Phi$ ,  $\Omega$ , and  $J/\psi$  and  $\psi'$  is found to be  $T_{\text{eff}} = 200 - 250$  MeV which is significantly lower than  $T_{\text{eff}}$  for protons or Lambdas. This observation indicates that  $\Phi$ ,  $\Omega$ , and  $J/\psi$  and  $\psi'$  pick up less radial flow, and their  $T_{\text{eff}}$  values are dominated by the temperature of an earlier phase of the system evolution. A similar observation was made for lepton pairs. The inverse slope parameters  $T_{\text{eff}}$  of the dimuon transverse momentum spectra measured in In+In collisions at 158 A GeV increases with invariant mass of the muon pair up to 1 GeV/c<sup>2</sup>, and then drops and stays constant for heavier masses. A possible interpretation of this effect is the following: the low mass muon pairs are created via  $\pi$ - $\pi$  collisions and, hence, are blue-shifted by the collective radial motion of hadrons, whereas the heavy muon pairs are created via q-q fusion in the partonic phase.

**Charm production and absorption** – Heavy charm quarks are very promising diagnostic probes of hot and dense nuclear matter. The (c,c-bar) pairs are created in hard parton collisions in the initial stage of the nucleus-nucleus reaction, and subsequently propagate through the dense medium. If this medium is deconfined, Debye screening hinders the formation of the charmonium hadronic state, and the charm quarks mostly combine with light quarks into hadrons with open charm. A suppression of the  $J/\psi$  yield relative to muon pairs from Drell-Yan processes was observed by the NA50 collaboration for central Pb+Pb collisions at 158 A GeV. However, absorption of  $J/\psi$  in cold nuclear matter also leads to significant charmonium suppression, which is able to explain most of the experimentally observed effect. Beyond this cold nuclear matter effect, an ‘anomalous’ suppression of  $J/\psi$  mesons by about 25% is still visible in very central Pb+Pb collisions. In establishing this result, knowledge about the  $J/\psi$  absorption cross section obtained from measurements in p+A collisions has been essential. In order to disentangle charmonium absorption in cold nuclear matter and shadowing effects from charmonium dissociation due to Debye screening in partonic matter, high-precision multi-differential data on charmonium and open charm production in nucleus-nucleus and proton-nucleus collisions are needed.

The suppression of charmonium can be ideally studied by normalising the yield of  $J/\psi$  and  $\psi'$  mesons to that for charmed mesons. However, no measurement of D mesons has been performed in heavy ion collisions at SPS energies up to date.

Future experiments will have to perform comprehensive and systematic measurements of open and hidden charm in order to fully exploit the potential of charm as a diagnostic probe of dense baryonic matter.

**Critical fluctuations** – The presence of a phase transition is associated with a rapid change (with temperature and chemical potentials) of the thermodynamic susceptibilities, which reflect the fluctuations of the active degree of freedom of the system. The well-known phenomenon of critical opalescence is a result of fluctuations at all length scales due to a second order phase transition. First order transitions, on the other hand, give rise to bubble formation, i.e., large density fluctuations. Therefore, an experimental search for a possible critical point and for a first order phase coexistence region in the QCD phase diagram has to include the measurement of particle number or momentum fluctuations event by event and correlations in heavy ion collisions as function of beam energy. Fluctuations of higher-order moments of particle distributions are expected to be particularly sensitive to the correlation length, which should fluctuate at the critical point. Experiments at top SPS and RHIC

energies so far did not find indications for non-statistical fluctuations, except for the measured kaon-to-pion ratio at low SPS energies. Future progress in the search for the critical point and a first order phase transition requires a careful beam energy scan in the region of low SPS/FAIR energies together with a systematic measurement of fluctuations of various observables event by event.

**Hadron properties in dense matter** – One of the most important goals of heavy ion collision experiments is to search for signatures of chiral symmetry restoration, which is expected to happen at very high baryon densities and/or temperatures. An observable consequence of chiral symmetry restoration would be a modification of hadron properties, as nuclear matter approaches the phase boundary. Indications for in-medium hadron modifications have been found for kaons and for vector mesons.

The yields and anisotropic flow of charged kaons show strong effects of in-medium modifications in heavy ion collisions at threshold beam energies as measured by KaoS, FOPI and recently by HADES. The measured results can be described under the assumption of a repulsive potential between  $K^+$  mesons and nucleons, and an attractive potential between  $K^-$  mesons and nucleons. This is in qualitative agreement with calculations based on the Chiral Lagrangian. The necessary detailed transport calculations, which need to include, e.g., off-shell dynamics, are only in a preliminary state and are not yet able to achieve satisfactory agreement

with the experimental data. From the current investigations it is apparent that these modifications do not allow a direct conclusion on chiral symmetry restoration. Nevertheless, it is a theoretical challenge to systematically explore chiral symmetry in nuclear many-body systems with kaons.

Dilepton decays provide direct access to the properties of light vector mesons in dense and/or hot nuclear matter. In heavy ion collisions at the SPS, CERES and NA60 found a significantly enhanced yield of lepton pairs in the invariant mass range between 200 and 700  $\text{MeV}/c^2$ . Figure 8 depicts the dimuon excess yield measured by NA60 for In+In collisions at 158 A GeV. The excess yield is defined relative to dimuon yields from known hadronic decays, including the  $\omega$  and the  $\phi$  meson. According to microscopic calculations, the excess dilepton yield is dominated by  $\pi\pi$  annihilation, which proceeds through the  $\rho$  vector meson due to vector dominance. The shape and the magnitude of the excess can be explained assuming that the  $\rho$ -meson mass distribution is substantially broadened. The calculations indicate that the coupling to baryonic resonances plays a crucial role.

A central objective of dilepton measurements is to find signatures of chiral symmetry restoration in the quark-hadron transition. To this end a connection between observables and chiral order parameters must be established. According to the calculations shown in Figure 8 the vector spectral function, which is dominated by the  $\rho$ -meson at invariant masses below 1 GeV, broadens to such an extent that it smoothly goes over to the quark rate in the plasma phase. Since chiral symmetry is restored in this phase the broadening of the  $\rho$ -meson could be viewed as a consequence of chiral symmetry restoration. A more direct measure of chiral symmetry restoration is the degeneracy of the vector and axial vector spectral functions. An important step forward would be the systematic derivation of both in-medium vector and axial vector spectral functions based on the Chiral Lagrangian, together with accurate dilepton measurements to constrain the vector channel. An additional bonus would be experimental information on the in-medium axial vector spectral function, possibly through the  $\pi^\pm\gamma$  channel.

The HADES collaboration has performed precision measurements of dilepton invariant mass spectra in nuclear collisions at beam energies of 1-2 A GeV. The HADES data confirm the results of the DLS collaboration for C+C collisions. Moreover, it has been experimentally proven that the dilepton spectra from C+C collisions correspond to a superposition of lepton pairs from p+p and p+n collisions. In heavier systems like Ar+KCl, however, a dilepton excess yield relative to the nucleon-nucleon reference data was observed. This effect is illustrated

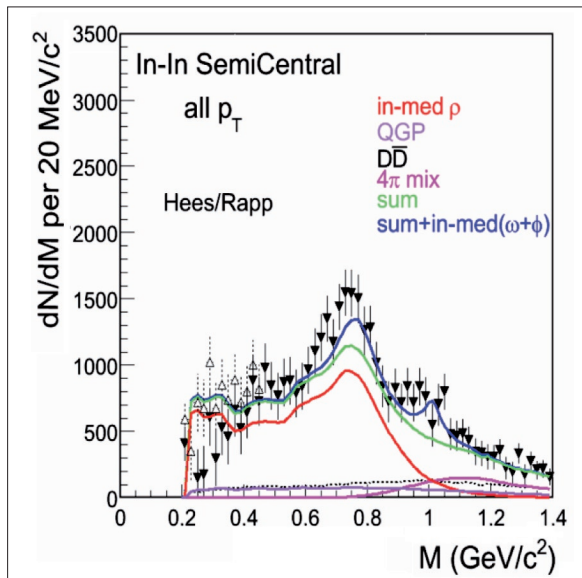

**Figure 8.** Dimuon excess mass spectrum measured by NA60 in In+In collisions at 160 A GeV (full symbols) compared to model calculations. (Courtesy of R. Rapp *et al.*)

## 4.2 Phases of Strongly Interacting Matter

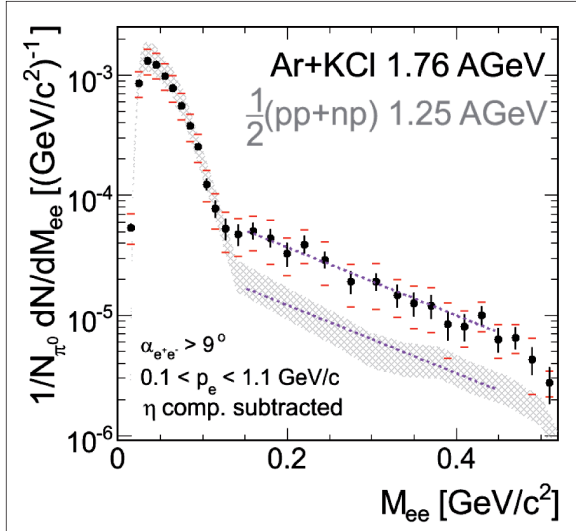

**Figure 9.** Di-electron invariant mass spectra measured by HADES. The Ar+KCl data (symbols) are compared to a superposition of p+p and p+n data, represented by the shaded area.

in Figure 9, which depicts the di-electron invariant mass spectra for Ar+KCl collisions (symbols), and for a superposition of p+p and p+n collisions (shaded area), both normalised to the measured pion yields. HADES will systematically study the origin of the dilepton excess in collisions of heavy systems up to Au+Au.

### Outlook

Strange particles and dileptons are the most promising diagnostic probes of nuclear matter at two to three times saturation density as created in nucleus-nucleus collisions at 1-2 A GeV. Strangeness production in nuclear collisions is being systematically investigated by the FOPI collaboration at GSI. Within this study, experimental evidence for the existence of a strange dibaryon decaying into a Lambda and a proton was found. The HADES collaboration has also started a strangeness programme, and identified double-strange  $\Xi$  hyperons at deep sub-threshold beam energies. HADES identified for the first time  $\omega$  mesons via the dilepton channel in collisions between light nuclei at low energies. These measurements should be continued and extended to heavy collision systems, both for strangeness and dileptons.

The theoretical conjecture of a first-order deconfinement phase transition and a QCD critical endpoint existing at large baryon-chemical potentials, together with the intriguing observations made in heavy ion collisions at low SPS energies, triggered new experimental activities at the major heavy ion laboratories:

the beam energy scan programme at RHIC, the fixed-target NA61/SHINE experiment at CERN-SPS, the NICA collider project at JINR in Dubna, and the proposed fixed-target Compressed Baryonic Matter (CBM) experiment at FAIR.

The collider experiments at RHIC and NICA have the advantage of a constant acceptance as function of beam energy. On the other hand, when running at low beam energies, collider experiments are restricted to the measurement of abundantly produced particles due to limitations in luminosity. The same is true for the experiment NA61/SHINE at the SPS, which operates at max. 80 Hz (although SPS could deliver much higher intensities). In contrast, the experiments at FAIR are designed for extremely high luminosities, enabling the systematic measurement of multi-differential cross sections with unprecedented statistics even for rare diagnostic probes like multi-strange hyperons, lepton pairs, charmonium and open charm.

The SIS-100 accelerator at FAIR will deliver heavy ion beams with energies up to 14 A GeV to the HADES and CBM experimental setups. This energy range is ideally suited to produce and to investigate net baryon densities as they exist in the cores of neutron stars. For the first time, penetrating probes like dileptons and multi-strange particles such as  $\Omega$ -hyperons will be used to study systematically the properties of baryonic matter in this beam energy range. The 30 GeV proton beams from SIS-100 will allow pioneering measurements to be performed on (open) charm production at threshold energies, as well as the detailed study of charm propagation in cold nuclear matter. The SIS-300 accelerator will deliver high-intensity heavy ion beams with energies up to 45 A GeV to the high-rate CBM experiment providing excellent conditions for the investigation of the QCD phase diagram at large baryon-chemical potentials.



---

## 4.2.5 The High-Energy Frontier

The much higher centre-of-mass energies reached by hadron colliders, notably LHC at CERN, provide entirely new opportunities for studying the phases of QCD matter. They provide, for the first time, access to the previously unexplored ultra-dense region of the QCD phase diagram far above the QGP transition temperature. In particular, progress is expected on the following subjects:

### 1. Collective phenomena above the QGP transition.

Generally, increasing the centre-of-mass energy in nucleus-nucleus collisions implies that the matter produced in the collision is initially denser, equilibrates faster and at a higher initial temperature, maintains equilibrium for a longer time, and fills a larger volume of space-time. All these features play a crucial role in the development of collective phenomena and thus help in determining macroscopic properties of hot and dense QCD matter.

### 2. Unprecedented access to hard probes of dense matter.

Scatterings with high momentum transfers, so called ‘hard probes’, lead to the production of jets, quarkonia and high-transverse momentum hadrons. The dramatic increase of the production cross-section makes them abundantly available at the TeV scale. The strong medium-modification of high-transverse momentum hadrons and jets, first seen at RHIC, allows properties of dense QCD matter to be characterised, while the study of the entire quarkonia families is expected to provide observables directly related to the deconfinement transition.

### 3. Saturated initial conditions.

In general, the characterisation of properties of hot QCD matter in heavy ion collisions relies on a complete understanding of the initial conditions from which this matter is produced, including the structure of the colliding nuclei. At collider energies, bulk hadron production is dominated by nuclear parton distributions at very small momentum fractions  $x$ . The parton distributions can be studied in proton-nucleus collisions at high energies. They are expected to reflect a qualitatively novel, maximally saturated state of cold QCD matter, which is solely accessible at ultra-relativistic energies.

Within the last decade, experiments at RHIC have started to substantiate the above-mentioned opportunities with data on A-A and d-A collisions at centre-of-mass energies of up to 200 GeV. The Large Hadron Collider, LHC, at CERN, has just begun physics operations in 2010 and is expected to be the world’s most powerful

accelerator for several decades to come. Its baseline programme foresees the study of Pb-Pb collisions at centre-of-mass energies up to 30 times higher than possible at RHIC. The dedicated heavy ion experiment ALICE, and smaller communities in ATLAS and CMS, have approved programmes for heavy ion physics. In addition, the LHC allows for proton-ion collisions and for the collision of lighter ions. Such an increase in centre-of-mass energy is unprecedented in the field of heavy ion physics. In the history of physics, order-of-magnitude increases in energy have always led to unforeseen discoveries which opened future new directions of research. Therefore, planning must remain flexible to cope with unforeseen and new findings emerging from first LHC data. Here, we exclusively focus on those opportunities which are strongly motivated by the current status of theory and experiment.

### Characterising QCD thermodynamics and QCD hydrodynamics

– The dense matter produced in ultra-relativistic heavy ion collisions locally exhibits random thermal motion. Yet, at the same time, it flows globally following pressure gradients determined by the global geometry of the collision. This picture is supported by the measured abundance of hadrons and their momentum spectra over a wide range of collision energies at the CERN SPS and RHIC. As a consequence, the study of collective flow has become a major tool for the characterisation of hot QCD matter. Collective flow effects increase with collision energy, consistent with the idea that an increased initial density results in larger pressure gradients driving the collective motion (see Figure 4).

The elliptic flow measured at RHIC is close to the predictions of ideal hydrodynamical models for momenta below 2 GeV (see Figure 10). This finding is remarkable, since ideal fluid dynamics describes the limiting case, in which matter is in perfect local thermal equilibrium. Collective motion is then maximal, leading to the most efficient response to pressure gradients. In this limit, collective dynamics depend entirely on the QCD equation of state, which may then be determined.

Characterising possible deviations of the elliptic flow signal from ideal hydrodynamics provides avenues for studying the properties of the QCD high temperature phase. Generally, these deviations arise from dissipative phenomena, which can be described by transport coefficients and relaxation times, as long as a fluid dynamic picture is valid. Transport coefficients, such as the shear viscosity, are of as fundamental importance as the Equation of State, in the sense that they can be calculated from first principles in QCD. Figure 10 illustrates how data on elliptic flow make it possible to experimentally constrain the shear viscosity, a particularly important transport coefficient. These experimental

## 4.2 Phases of Strongly Interacting Matter

### Box 4. Nuclear matter as a nearly perfect fluid

One of the clearest manifestations of collective behaviour in heavy ion collisions is the observed large elliptic flow (see figure). The measured elliptic flow at RHIC is well described by almost-ideal hydrodynamics. (Ideal hydrodynamics applies to fluids with no viscosity, so called perfect fluids.)

A low viscosity fluid like water supports flow patterns, e.g., the waves in the ocean. In contrast, in a viscous fluid like honey, flow patterns decay quickly. The physical quantity that differentiates between such fluids is the ratio of shear viscosity  $\eta$  to the entropy density  $s$ .

The figure shows the value of  $\eta/s$  in natural units versus temperature for different fluids. Water close to the triple point reaches a value of  $\eta/s = 2$ , while for liquid helium the ratio is as low as  $\eta/s = 0.7$ . A conservative bound from the comparison of viscous hydrodynamical models with data yields a value of  $\eta/s \leq 0.4$  for the quark-gluon plasma fluid.

The appearance of a minimum in  $\eta/s$  raises the fundamental question whether there is a lower bound on how perfect a fluid can be. In conformal field theories with gravity duals (Anti-de Sitter/Conformal Field

Theory), the ratio is known to be  $\eta/s = 1/4\pi$ . It has been conjectured that this value is a lower bound for any relativistic thermal field theory.

Large elliptic flow and small viscosity are not only observed in the fluid created in heavy ion collisions but are also found in experiments where ultra cold matter is confined in a magnetic trap. In these traps the interaction strength between atoms can be tuned by changing the confining magnetic field. It turns out that almost perfect fluid behaviour is observed at maximum coupling. This shows that flow phenomena can be related to the coupling strength. Thus, the flow measured at RHIC and to be explored at LHC should allow for the study of the coupling strength in hot and dense nuclear matter.

Ultimately one would like to understand the dynamical origin for such almost-perfect fluid behaviour of the matter created at these energies. Measurements of collective flow at the LHC will significantly improve our understanding and description of the nuclear matter at the highest temperatures that can be reached experimentally.

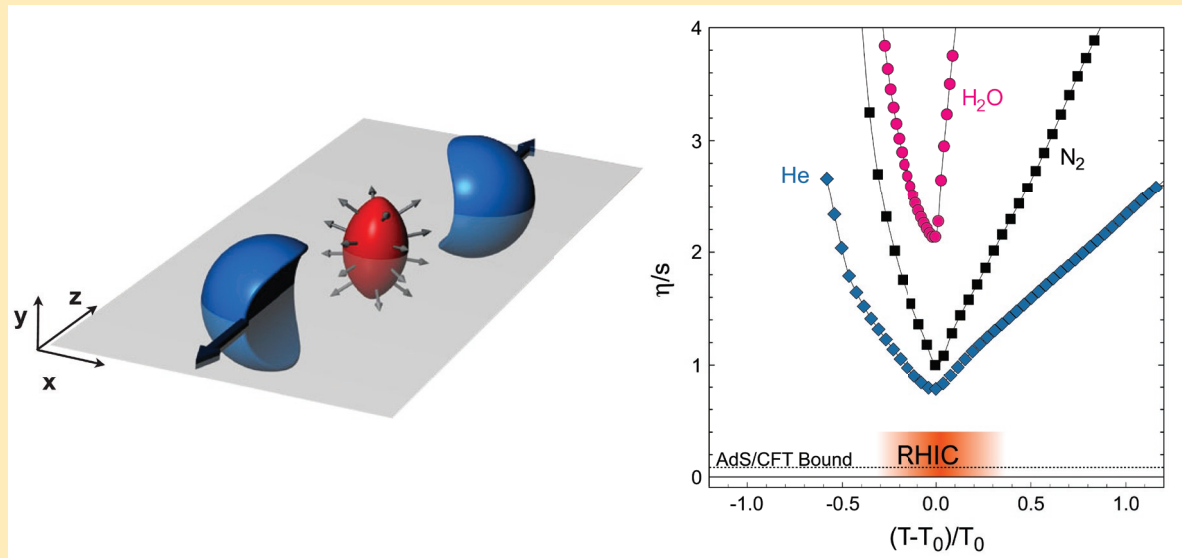

Left: Almond shaped interaction volume after a non-central collision of two nuclei. The spatial anisotropy with respect to the x-z plane (reaction plane) translates into a momentum anisotropy of the produced particles (elliptic flow).

Right: The ratio  $\eta/s$  versus temperature for several liquids. (Courtesy of R. Lacey *et al.*)

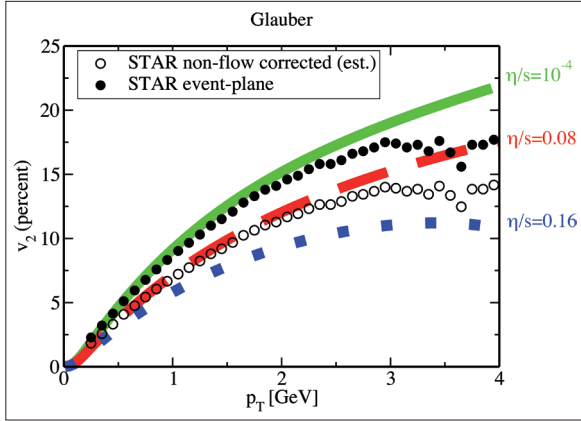

**Figure 10.** Elliptic flow parameter ( $v_2$ ) versus transverse momentum ( $p_T$ ) for charged hadrons measured at RHIC and compared to fluid dynamic simulations. The data come close to the predicted limit of ideal hydrodynamics (green line), and favour fluid dynamic evolutions assuming a small but finite ratio of shear viscosity over entropy density. (Courtesy of M. Luzum)

advances have been paralleled by first calculations in the strong coupling regime, based on novel string-theoretical techniques and lattice QCD calculations. It is one of the most remarkable findings of heavy ion physics in recent years that these calculations predict values of shear viscosity over entropy density which are much smaller than the corresponding values for any known substance and, at the same time, are consistent with values extracted from RHIC data using phenomenological models (see Figure 10). This lends support to a picture of the deconfined QCD high-temperature phase, in which particle-like constituents play no role for the observed transport phenomena. This is distinctly different from the picture of a gas of free or perturbatively interacting quarks and gluons.

Heavy ion collisions at the LHC will determine whether the above picture of a strongly coupled plasma characterises the generic features of the QCD high-temperature phase, or whether its range of validity remains limited to the neighbourhood of the QGP transition temperature to which RHIC has experimental access. In particular, calculations of lattice-regularised QCD provide indications that characteristic properties of the QCD high-temperature phase, such as its interaction measure ( $\epsilon - 3p$ ), or its bulk viscosity, undergo qualitative changes if the temperature is raised well above the QGP transition temperature, as should be possible at the LHC. These changes are regarded as signalling the onset of a gradual transition of the quark gluon plasma to more and more gas-like properties at higher temperatures. Experiments at the LHC will reach into this yet unexplored high-temperature region. They can thus provide insight into the question how Nature realises the transi-

tion from a minimally viscous, strongly interacting fluid to a gas-like state at extreme temperature. In the first discovery phase of the LHC heavy ion programme, such perspectives call for a multi-pronged approach.

LHC experiments are well set to constrain our understanding of QCD thermodynamics and transport theory in the QCD high temperature phase. Within the LHC baseline programme of Pb+Pb collisions, this includes the measurement of abundances, spectra and collective flow in terms of their dependence on particle species, transverse momentum, rapidity, collision centrality, etc. In addition, it is necessary to better constrain the initial conditions of the collective phenomena, since they are currently a major source of uncertainty in determining properties of hot matter. Experimental avenues to this end are provided, in particular, by proton-nucleus collisions, that provide an opportunity for identifying separated from that of a complex collective expansion. Also, the dependence of collective flow on the centre-of-mass energy of the collision provides important constraints, since it allows one to scan the dependence of properties of matter on the initial temperature and density attained in the collision.

On the theoretical side, the analysis of LHC data requires phenomenological modelling of the collision dynamics to relate experimental data to first principles calculations in QCD. The development and further improvement of essential modelling tools such as hydrodynamic simulation programmes is of crucial importance. Moreover, first principles calculations of important properties of hot QCD, such as transport properties at strong coupling, have only started. Numerical estimates indicate that reliable LQCD simulations of transport coefficients like shear viscosity require petaflops machines. Finally, the recent calculation of shear viscosity by use of the so-called AdS/CFT correspondence marks historically the very first time that a string-theory based calculation has triggered a field of experimental analysis and has provided guidance for a class of challenging QCD calculations. In recent years, a fruitful interdisciplinary discussion between string theory and nuclear physics has developed, which promises conceptually novel approaches to long-standing questions in our understanding of the QCD high-temperature phase. These efforts should be further encouraged and supported.

### Characterising the QCD plasma with hard probes

Experiments at RHIC have established that in nucleus-nucleus collisions, the production of hadrons at high transverse momentum (above about  $p_T = 5$  GeV/c) is strongly suppressed. This is evidenced by the so-called nuclear modification factor  $R_{AA}$ . Single inclusive hadron spectra show a suppression of the high- $p_T$  particle yield by a factor  $\sim 5$  in the most central collisions (see Figure 11)

## 4.2 Phases of Strongly Interacting Matter

compared to elementary p+p collisions. This suppression persists for all measured hadrons up to the highest transverse momenta measured so far. The suppression has a characteristic centrality dependence: it vanishes in very peripheral collisions and is not observed for photons. These findings support a picture in which highly energetic quarks and gluons, produced in the first partonic collisions, lose energy in the surrounding dense QCD matter prior to fragmenting into the observed high- $p_T$  hadrons. This interpretation is also supported by the measurement of jet-like particle correlations.

With the discovery of the ‘jet quenching’ phenomenon at RHIC, the study of high transverse momentum processes has become one of the major new fields of research in high-energy nucleus-nucleus collisions. This is so, since hard processes promise to provide qualitatively novel tools for the study of hot QCD matter. On the one hand, they can be calibrated both experimentally and theoretically with unprecedented accuracy in the absence of medium effects. On the other hand, they show on top of this well-controlled baseline a strong sensitivity to properties of the hot and dense QCD matter.

For the useful exploitation of hard processes as probes of the medium, an unambiguous interpretation of jet quenching in terms of specific medium properties is needed. This requires experimental constraints on the parton dynamics underlying jet quenching. At present, the conclusions about medium properties drawn from jet quenching are consistent with estimates of the matter density obtained by other means. However, they show significant model dependences. This currently limits the practical use for characterising properties of the produced plasma. These uncertainties can be largely removed by additional measurements, including for instance the modification of characteristic internal jet structures such as jet multiplicity, jet broadening, and jet hadrochemistry, or the determination of the hierarchy in the suppression pattern of light-flavoured and heavy-flavoured hadrons. Such refined measurements have the potential to provide detailed information about the parton composition of the produced hot matter and about its transport properties. To date, data from such refined measurements are either not yet available, or their precision allows only for rather qualitative conclusions about the properties of the medium.

As may be seen from Figure 12, the higher centre-of-mass energy at the LHC will make it possible to extend the kinematic reach for the characterisation of hard processes in dense QCD matter by, typically, one order of magnitude in transverse momentum. The much larger production rates at higher centre-of-mass energy drastically improve the statistical precision over that of previous measurements. The much wider kinematic reach also facilitates the identification and analysis of hard

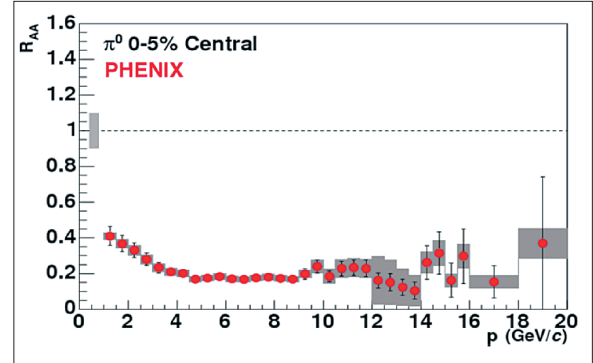
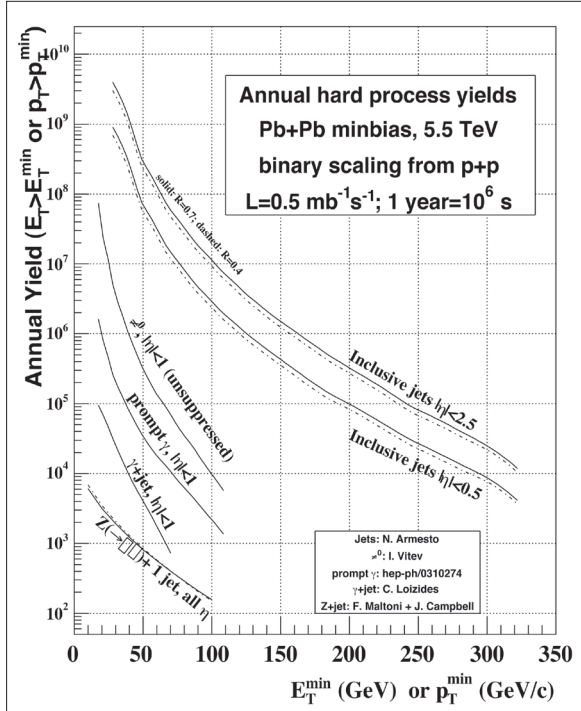

**Figure 11.** Nuclear modification factor of neutral pions as a function of  $p_T$ , measured in central  $\sqrt{s} = 200$  GeV Au-Au collision at RHIC.  $R_{AA}$  is the ratio of the particle yield in nucleus-nucleus collisions, compared to the yield in an equivalent number of proton-proton collisions.

probes, since they stand out more prominently above the background, even in the high-multiplicity environment of heavy ion collisions. In addition, qualitatively novel measurements of hard probes, such as ‘true’ jets above 50 GeV, and their internal structure become experimentally accessible. They will clarify the above-mentioned questions, and will significantly enhance the use of hard probes for characterising plasma properties.

Beyond clarifying central open questions in the current interpretation of jet quenching, the study of hard probes at the LHC is also expected to open up qualitatively new directions in the investigation of extreme QCD matter. A prominent example is the measurement of confinement-related observables by a characterisation of the entire charmonium and bottomonium family in hot QCD matter. The radii of the tightly bound heavy quark-antiquark systems provide a unique set of decreasing length scales in strong interaction physics. On general grounds, it is expected that the attraction between a heavy quark and an antiquark is sensitive to the medium in which the bound state is embedded. This attraction weakens with increasing temperature, when the medium screens the quark colour charges from each other. Some quarkonia states are through their radii sensitive to the screening length, the natural length scale displayed by the medium produced in heavy ion collisions, which is directly related to the inverse temperature  $1/T$ . Thus, a characterisation of the yield of bound states of both families provides a unique opportunity for characterising the temperature and screening of the QGP. Lattice QCD results provide predictions of the mass-hierarchy of these charmonium suppression patterns. At the LHC, such measurements of sufficiently abundant yields of charmonium and bottomonium states will become experimentally accessible for the first time.





**Figure 12.** Expected yield of several classes of hard processes as a function of transverse energy  $E_T$ , resp. transverse momentum  $p_T$  calculated for one month of Pb-running with design luminosity at 5.5 TeV. (Courtesy of P. Jacobs and M. van Leeuwen)

The first experiments with heavy ions at the LHC will mark the start of a discovery era, exploring a vast, as yet uncharted kinematic regime. In the above, we have highlighted fundamental open questions in the investigation of hard probes, which can be firmly motivated and can be addressed by experiments at the LHC. It is conceivable that, in addition, the much higher precision and much wider kinematic range of the LHC brings further fundamental questions into experimental focus, or that it reveals profound new phenomena. Since the availability of ion-beams at dedicated proton-proton colliders depends on many factors, it will be mandatory to react swiftly and to support strongly any experimental follow-up which may emerge during the LHC discovery phase.

According to our current understanding, the full exploitation of the novel physics opportunities for hard probes at the high-energy frontier requires, first of all, a detailed exploration of the novel kinematic regime with statistical and systematic precision. This calls for sufficient beam time close to nominal luminosity, as well as the availability of proton-proton, proton-Pb, and possibly lighter ion beams to be able to discriminate plasma properties from other nuclear effects. These require a long-term experimental programme. It also calls for full support of all

relevant experimental and analysis resources, including the significant computing resources needed for triggering on hard probes and analysing the data.

Finally, we emphasise the important role of nuclear theory in analysing the vast amount of data on hard probes at hadron colliders. In the study of hard probes, nuclear theory faces the challenge to interface a highly sophisticated and experimentally tested understanding of hard QCD processes in the vacuum with an a priori unknown interaction of these processes with the QCD plasma, into which they will be embedded for the first time. The role of theory is not limited to providing firm first-principle calculations of the sensitivity of hard probes to QCD thermodynamic and transport properties. It also includes the development and further improvement of complex phenomenological modelling tools, which are indispensable for relating measured medium-modifications of hard processes to characteristic plasma properties. And it starts to include essential theoretical contributions to data analysis techniques, such as the recent developments of fast jet finding algorithms, which can perform within the high-multiplicity environment of heavy ion collisions. This multi-faceted work is needed to identify new opportunities and to draw firm conclusions in a timely fashion. All work towards an improved interplay between experiment and theory should be strongly supported.

**Saturated gluon matter** – The knowledge of the density of quarks and gluons (partons in general) in a proton or a nucleus is crucial information for the understanding of high-energy scattering. While the parton distribution functions (PDFs) are relatively well-known for the proton, nuclei cannot be treated as simple superpositions of protons and neutrons. Their PDFs are subject to large uncertainties in kinematic regions of interest to current experiments.

Even more interestingly, the parton density seen in a proton or nucleus is known to increase at large momentum transfer  $Q^2$  (i.e., high spatial resolution) when the momentum fraction  $x$  they carry decreases. At low parton density, this density increase is linear and can successfully be described within perturbative QCD. This increase cannot, however, continue indefinitely. At some point the large number density of gluons would violate fundamental unitarity bounds and, in fact, for large densities non-linear effects, become important and compensate the increase with a corresponding decrease due to gluon fusion processes. This balance of creation and annihilation leads to the so-called gluon saturation.

Gluon saturation is a small  $x$  phenomenon that sets in below a certain characteristic scale in  $Q$ , the saturation scale  $Q_s$ . This scale, and with it the momentum range

## 4.2 Phases of Strongly Interacting Matter

where this matter is visible, increases with decreasing parton momentum fraction  $x$ . Saturation effects are generic phenomena of all hadrons, including protons and nuclei; however, due to the higher gluon numbers in nuclei they are enhanced by a factor  $A^{1/3}$ , and so is the saturation scale. The experimentally accessible saturation region increases substantially with centre-of-mass energy (see Figure 13).

Investigations of this state will enter a completely new, as yet unexplored regime of quantum field theory. It also plays an important role in defining the initial conditions for any high-energy hadronic interaction. Its investigation will have far-reaching consequences in high-energy physics.

Generally, saturated gluon matter reveals itself through two characteristic signatures:

1. a modification of the momentum distributions of gluons; and
2. a change from a collection of incoherent gluons to a coherent state.

The standard approach to studying parton distribution functions (PDFs) is via deep inelastic scattering (DIS) of leptons. DIS can nicely constrain the parton kinematics (i.e.,  $Q^2$  and  $x$ ). However, it is only indirectly sensitive to the gluon distribution since gluons carry no electric charge. The PDFs can be tested in their entirety by measuring the quark structure functions and using evolution equations to extract information on the gluons.

On kinematic grounds, it is expected that the first important information about the saturation region can be obtained from proton-nucleus collisions at the LHC. These studies will significantly reduce uncertainties in the nuclear PDFs. In addition, p-A collisions are unique for the study of strong interaction effects of the initial state, e.g., multiple scattering. It is therefore vital to establish a proton-nucleus collisions programme at the LHC.

Hadronic reactions directly probe the gluon distributions. To test gluon saturation against the low-density picture of point-like parton-parton scatterings, a reasonably large transverse momentum  $p_T$  of the produced particles (optimally significantly larger than 1 GeV/c) is needed. This will ensure that the momentum transfer  $Q$  is large enough for perturbative QCD to be applicable as a reference. For a given  $p_T$ , the lowest value of  $x$  that can be attained decreases with increasing collision energy and increasing longitudinal momentum (or rapidity  $y_h$ ) of the produced hadron. To study saturated gluon matter it is therefore advantageous to measure particle production at large  $y$  in p+A collisions at the highest beam energies available – measurements at forward angles<sup>1</sup> in these reactions at the new LHC accelerator are thus optimally suited for this purpose.

At hadron colliders, effects of the gluon saturation can be seen in:

1. a suppression of inclusive hadron yields in a momentum range where parton scattering is dominant; and in
2. a decrease and/or broadening of the azimuthal correlation related to recoil jets from parton-parton scattering.

Qualitatively such effects have been observed at RHIC, in particular the suppression of hadrons produced at forward rapidities. However, no consistent calculation of the nuclear modification factor from a gluon saturation model has been performed yet. Moreover, it is questionable whether the small  $p_T$  range studied at RHIC allows for a unique interpretation of the suppression.

Measurements at the LHC with its much larger dynamic range facilitate a breakthrough for such studies. Figure 13 illustrates the kinematic reach as a function of hadron  $p_T$  and  $y$  at the RHIC and LHC accelerators. At LHC,  $x$ -values are already smaller at a given rapidity, such that the saturation region extends out to larger  $p_T$ -values. In addition, a much larger range in rapidity is accessible at LHC. In general, the LHC will give access to a significantly larger part of phase space dominated by gluon saturation, and will in particular allow the use of  $p_T$  values high enough that perturbative QCD can be used as a reference.

To measure the effects of gluon saturation in experiments, one has to be sensitive to relatively low transverse momenta for centrally produced particles, while at

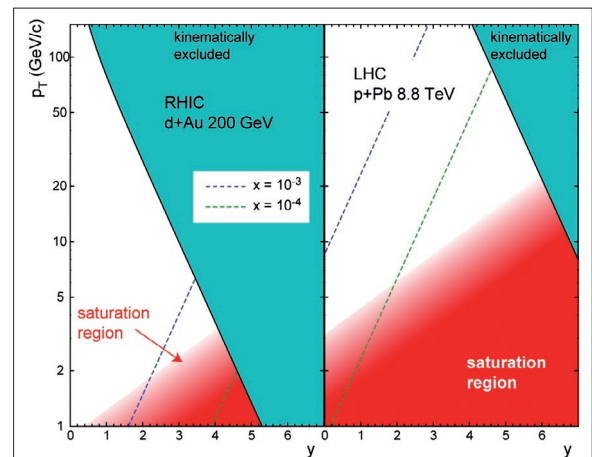

**Figure 13.** Accessible phase space for hadron production as a function of rapidity  $y_h$  (see text) and transverse momentum  $p_T$  in collider experiments at RHIC and LHC. The red areas indicate estimates of the region where gluon saturation should be observable ( $p_T < Q_s$ ).

1. Large rapidity corresponds to small angles relative to the beam axis, i.e., the forward region.

the same time being able to precisely measure forward produced particles in a wide range of transverse momenta. In this way, the entire range of the saturation region indicated in Figure 13 would become accessible. While the present design of the ALICE experiment is perfectly suited for the thorough characterisation of particle production in the central region, the addition of instrumentation in the forward rapidity region will be indispensable for the study of the saturation region. This could be achieved with a state-of-the-art high-granularity electromagnetic calorimeter currently under evaluation as a possible upgrade of the experiment.

Traditionally, in high-energy physics, hadron accelerators pave the way to discoveries while the electromagnetic probes provide precision tools. Therefore, in the long-

term perspective, electron-proton and electron-ion collision data will be indispensable for a precise and unambiguous characterisation of the small- $x$  structure of nuclear matter and the saturation regime. The currently available data from e+p scattering at HERA have been shown to be consistent with the gluon saturation picture, but can also be explained by linear evolution. Stronger signals of gluon saturation from DIS will require e+p or e+A collisions at still higher energy compared to HERA. A future high-energy hadron-electron-collider (LHeC), as currently being discussed as a future project at CERN, would be designed to penetrate deeply into the saturated region, thus providing a unique opportunity for determining the saturation scale and characterising the properties of the saturation region.

### Box 5. Gluon Saturation

While ordinary substances exist as gases, liquids or solids, there are states of matter that evade this classification. In particular, glasses appear as solids on short time scales, but actually flow like liquids over much longer times. A state of such ambiguous properties is predicted to be visible in high-energy collisions.

It has been known for a long time that the quarks inside nucleons and nuclei are ‘glued’ together by so-called gluons, the force-carriers of the strong interactions. The actually observable constituents of, e.g., a proton depend on the resolution used as illustrated in the figure. For coarse spatial resolution (i.e., low energy, left side of the figure) one observes mainly the three valence quarks which, e.g., comprise the total charge of the proton. When increasing the beam energy, the spatial resolution is enhanced and one can observe more and more colour charges (mainly gluons, but also quarks and antiquarks). These particles carry ever smaller fractions  $x$  of the total momentum of the proton. At very high energy (right side), the density of gluons is so large, that they are no longer seen as independent particles, but form a new state of matter, the classical field limit of the strong interaction. The density of gluons in this saturated state is high enough for the colour field to exhibit classical properties. At short time scales relevant for particle production, the state appears to be frozen as in a solid. Over long time scales, however, it evolves slowly, like a glass.

The enormous increase of the gluon number with small  $x$  is understood from splitting processes of gluons. At high enough density, however, gluons will collide and merge frequently enough to lead to a balance between splitting and merging. This will lead to a saturation density. It is characterised by a characteristic maximum momentum, the *saturation scale*  $Q_s$ , which can be

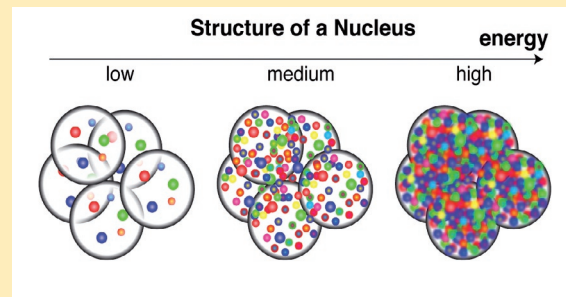

Quark Gluon structure of a nucleus seen at increasing collision energies.

calculated theoretically. In nuclei, the projected area densities of gluons should be even higher and effects of gluon saturation should thus be stronger, leading, e.g., to a larger saturation scale.

Our understanding of interactions in microscopic systems relies on the existence of quanta (like the photon for the electromagnetic interaction), but in macroscopic physics interactions show the properties of classical fields. So far, the electromagnetic interaction is the only example where we observe both manifestations. On the one hand, gravitation has a clear classical phenomenology, but the description (and observation) of its quantum nature is one of the big puzzles in physics. Subatomic interactions, on the other hand, are genuinely quantised – we observe the quanta in particle physics experiments, but no classical system has been observed yet, where the individual quanta would be no longer important. Of those interactions, the weak interaction offers no hope to study this effect experimentally. For the strong interaction, the predicted new state of matter can be explored experimentally in ultra-relativistic electron-nucleus and proton-nucleus collisions.

## 4.2 Phases of Strongly Interacting Matter

---

### 4.2.6 R&D, Computing, Networking

**New generation of detectors, front-end electronics, DAQ** – Forefront experiments in nuclear physics require, in general, innovative instrumentation. Therefore, better performing accelerators, detectors, data acquisition and the associated highly sophisticated electronics are in continuous demand. At moderate energies, pulse shape analysis of stopped charged particles in silicon permits to identify all atomic and partially even their mass numbers. Meanwhile, modern implementations of the standard  $\otimes$ E/E approach have reached unprecedented mass identification up to  $Z=50$ . This has been achieved via fast, high-resolution digitisation in conjunction with sophisticated digital signal processing. Moreover, close relationships with silicon manufacturers are necessary in order to obtain silicon wafers free of ‘channeling’. This is achieved with the highest possible doping uniformity (1%).

Next generation particle detectors have to be operated at extremely high counting rates and track densities. At the same time, these detectors have to provide excellent time and position resolution, as well as a low material budget to reduce multiple scattering and background. Evolving detector technologies with a rich R&D programme include: advanced diamond detectors, frontier photon detectors based on nanotechnology, inorganic scintillation fibres, or on silicon photo multipliers, large-area low-mass gas counters, fast compact Cherenkov counters for particle identification, ultra-light and large-area tracking systems based on GEM or Micromegas technology, ultra-light tracking and high-resolution vertex detection systems based on silicon sensors. The future CBM experiment at FAIR will be confronted with the selection of rare probes in high multiplicity environment at collision rates of up to  $10^7$  events/sec. Therefore fast, large granularity and radiation hard detectors for electron as well as hadron identification, high resolution secondary vertex determination and a high speed event-selection and data acquisition system have to be developed. The ongoing R&D activities along these lines have to be continued in order to exploit the high intensity beams envisaged at the future FAIR facility by the CBM experiment.

At the same time, the ALICE upgrade programme will enhance the present discovery potential and make use of the high luminosity of LHC. Recent developments in integrated circuit technology and advances in computing and networking power significantly improved the performance of all experiments in nuclear physics. Field-programmable gate arrays, including more than

one million logic gates, are used in fast trigger-, pattern recognition-, real-time tracking and position-determination circuits and event builders. Upgrades of present experimental devices and design of future ones will take advantage of these developments and advances in fast digitisers. Optical fibres and transceiver performance with transfer rates of 5–10 Gbits/s/link is now available off-the-shelf. Therefore, event building and recording rates of up to 1 Gbytes/s is within reach.

The storage and analysis of the resulting dataset that are of the order of hundreds of Petabytes (1 Petabyte = 1 million Gigabyte) pose challenges that must be addressed by new developments in distributed computing and GRID technology.

**Computing requirements** – The complexity of the experimental devices and physics programmes of high-energy nuclear physics has already reached the level typical for particle physics experiments. The new generation nuclear physics experiments will exceed HEP experiments in terms of computing requirements, both CPU power and data volume. The recommendation made in the previous LRP for developing GRID computing infrastructures has turned into an essential need.

The GRID has demonstrated its potential to distribute computing resources in a coherent fashion, and the ALICE Grid implementation is one of the most efficient such structure within the Worldwide LHC Computing Grid. In view of this, a joint venture between the nuclear and particle physics communities will be beneficial to both programmes. The LHC experiments offer a very good starting point in this direction.

At present, lattice calculations are the only means to extract exact non-perturbative predictions of QCD from first principles, playing an important role in the interpretation of the existing experimental results and in the prediction of observables to be measured by future experiments. Accomplishments over the last five years have established the methodology and laid the groundwork for lattice QCD calculations. Dedicated hardware and software infrastructure is necessary for world-class lattice QCD research. As the demands of full QCD computations grow with a large inverse power of the quark mass, initial calculations were restricted to relatively heavy quarks. To reach the required accuracy requested by the experiments, simulations for physical quark masses and close to the continuum limit are mandatory. To reach this goal, petaflop/scale computing facilities, a unified programming environment, and a pooling of resources are required.

It has proven more cost effective to build dedicated computers rather than to make use of general purpose machines. QPACE (QCD parallel computer using cell



---

technology), a three-dimensional architecture based on enhanced Cell BE processors, with an aggregate peak performance of more than 416 (208) teraflop/s in single (double) precision will become operational in the near future. For a petaflop/s performance utilising the full capacity of the next generation of multi-core processors, a more powerful communication network needs to be developed. In this respect, the apeNEXT computer initiative at the European level was remarkable. For thermodynamics calculations, with moderate demand on computer memory and communication, high-end graphic cards (GPUs) promise to be a powerful alternative to massively parallel architectures. Similar strategies are followed for the next generation of high-level trigger architectures foreseen to be used for FAIR or for future high luminosity LHC experiments, where rare events of interest must be selected on-line in a collision rate environment up to  $10^9$  times higher. Interpretation of the experimental results in terms of fundamental properties of matter requires sophisticated modelling of the collision dynamics based in principle on three-dimensional viscous relativistic dynamics followed by hadronic Boltzmann transport calculations. Such large-scale calculations can be efficiently performed on computing infrastructures of the GRID type.

**Network of Excellence** – When the nuclear physics community embarked on relativistic and ultra-relativistic heavy ion collisions, R&D activities were started at the European level. Over the years, the community has built up a real network of excellence of infrastructures and expertise across Europe. This network has had a major impact on the development of high performance detection and identification methods, associated front-end electronics, building important parts of large-scale experiments, structuring distributed computing centres as part of large-scale GRID infrastructures and physics programmes of the associated international collaborations. This unique achievement has to be consolidated to secure its contribution for running the experiments, for fully exploiting their physics potential as well as for the preparation and construction of future experimental facilities. In this respect, the former initiative of IUPAP to produce a compendium of European facilities involved in research activities along Nuclear Physics key issues must be continued and extended to the level of a European Network of Excellence, as a component of the large-scale infrastructures network. Based on well-defined criteria, on-line monitoring and regular evaluation of its components, such a network can serve as an expert panel for governmental or inter-governmental organisations to secure their financial support and promote the field of nuclear physics on an international level.

## 4.2.7 Recommendations

**1) The understanding of the properties of the Quark Gluon Plasma requires the full exploitation of the unique new energy regime opened up by the LHC at CERN. Support for a comprehensive physics programme with proton-nucleus and nucleus-nucleus collisions at several energies and upgrades of the ALICE detector must be assured.** This entails a long-term investment in a vigorous programme with nuclear beams at the highest possible luminosities for the next decade. In addition, a proton-nucleus collision programme must be pursued to provide access to the physics of gluon saturation and to elucidate the interplay between cold nuclear matter effects and genuine plasma features. A programme of focused upgrades of the ALICE detector at LHC must be developed to further extend the physics reach into kinematically presently unexplored and unavailable regions.

**2) The construction of the FAIR accelerators and the CBM experiment must be strongly supported in order to open up in order to enable the study of matter at extremely high baryonic densities.** Such studies will shed light on the nature of the phase transition to a Quark Gluon Plasma and on the existence of a critical point in the phase diagram of matter that interacts via the strong interaction. Progress will be driven by experiments at the SPS, at SIS100 and SIS18, operating at the highest luminosities. The future high-intensity beams from SIS-300 coupled with a detector capable of operating at very high rates will provide access to rare probes.

**3) Experiments using beams of rare (n-rich and n-poor) isotopes are essential for understanding the isospin properties of nuclear matter and the nuclear liquid gas phase transition and require the construction and use of FAIR and SPIRAL2 (with the energy upgrading).** Suitable beams in an energy range from several tens to hundreds of MeV/u at SPIRAL2, SPES, FRIBS (LNS) and FAIR are required. In addition, support is needed for new detectors with low detection threshold detectors with large solid angle coverage and good isotopic resolution like FAZIA.

**4) Nuclear theory is essential to exploit fully the new opportunities arising from existing and future facilities and to identify future opportunities, and should be strengthened at the European level.** The rigorous determination of as yet unquantified properties of the QCD phase diagram, which are now coming into experimental reach, requires supercomputers in the

## 4.2 Phases of Strongly Interacting Matter

---

petaflop/s-range dedicated to this task. Strong support of theoretical modelling to link the upcoming experimental data to fundamental theory is needed.

**5) Computing facilities have become a key factor in the modelling and analysis of experimental data in this field. Funding and human resources for the maintenance and further development of sustainable large-scale high-performance computing resources, such as the GRID, must be secured.**

**6) A dedicated very-high centre-of-mass energy electron-nucleus collider (LHeC) will open up entirely new possibilities for the study of extreme QCD matter in the future.** Forefront accelerator and detector R&D must be supported to rapidly reach a technical design for such a facility.

**7) Progress in the field is marked by large international collaborative efforts. Continuing support for networking infrastructures is needed.** Suitable career programmes for young researchers, in theory and experiment, need to be fostered in order to exploit fully the long-term perspectives.

## 4. Scientific Themes

---

### 4.3 Nuclear Structure and Dynamics

**Convener:** Rauno Julin (Jyväskylä)

Navin Alahari (Caen),  
Thomas Aumann (Darmstadt),  
Yorick Blumenfeld (CERN),  
Peter Butler (Liverpool),  
Hans Fynbo (Aarhus),  
Andres Gadea (Valencia),  
Wolfram Korten (Saclay),  
Adam Maj (Kraków),  
Gerda Neyens (Leuven),  
Thomas Nilsson (Göteborg),  
Robert Roth (Darmstadt),  
Patricia Roussel-Chomaz (Caen),  
Christoph Scheidenberger (Darmstadt),  
Andrea Vitturi (Padova),  
Dario Vretenar (Zagreb)

**NuPECC Steering Committee Member:**

Angela Bracco

**NuPECC Liaison:**

Maria José Garcia Borge

## 4.3 Nuclear Structure and Dynamics

### 4.3.1 Introduction

In Nature strongly interacting matter is found in the form of atomic nuclei, built from quarks and gluons that are confined into protons and neutrons (nucleons). The high-energy bare interaction between constituent particles is described by QCD, the fundamental theory of strong interactions. However, at energies characteristic for nuclear binding the strength and complexity of QCD complicates immensely the understanding of nuclear phenomena in terms of these fundamental degrees of freedom.

Nuclei typically consist of many nucleons, up to 300, resulting in a rich variety of quantum phenomena. It is the task of nuclear structure physics to unravel this myriad of quantum structure and to find the ordering principles governing nuclei. This endeavour is very broad in scope, mirroring fields such as solid state physics, atomic structure physics and atomic collision physics in which the Coulomb interaction is accompanied by the much more complicated strong interaction. A correspondingly versatile set of tools, both theoretical and experimental, are required to advance our understanding of this diverse field.

Present and future research in nuclear structure physics aims at providing answers to key questions:

- *How can we describe the rich variety of low-energy structure and reactions of nuclei in terms of the fundamental interactions between individual particles?*
- *How can we predict the evolution of nuclear collective and single-particle properties as functions of mass, isospin, angular momentum and temperature?*
- *How do regular and simple patterns emerge in the structure of complex nuclei?*
- *What are the key variables governing the dynamics between colliding composite systems of nucleons?*

A real challenge is the understanding of nuclei very far from stability, these nuclei being the precursors in the formation process of the stable nuclei on earth. The advent of the first generation of Radioactive Ion Beam (RIB) facilities has already opened up new possibilities to probe these unstable nuclei and access new regions of the nuclear chart. In the last decade, many of the important experimental results in nuclear structure and dynamics have been obtained at these facilities. However, only circa 3000 of the possibly more than 8000 different nuclei that should exist have been probed or identified, the large terra incognita being the very neutron-rich nuclei and super-heavy elements.

With the start-up of new and the upgrade of existing RIB facilities and innovative experimental techniques, nuclear research stands on the verge of a new era,

where a much wider range of proton- and neutron-rich nuclei will become accessible. The availability of a large variety of unstable projectiles accelerated to different energy regimes, opens up new physics opportunities, at the interplay between nuclear structure and reaction dynamics.

Intense stable-ion beams will retain their vital role in studies of nuclei at the proton drip-line and even beyond and to study phenomena driven by spin and temperature. They are also particularly needed in studies and production of super-heavy elements.

Recent experimental and theoretical developments, research challenges together with significant investments in nuclear structure studies have led to growing connections with other fields of science and applications. Particularly in nuclear astrophysics, many questions are intimately connected to nuclear structure and reaction problems.

The understanding of excitation properties of nuclei requires the modeling of the dynamics involved in the nuclear excitation process. Major advances are being made in nuclear theory in this regard. However, there is presently a real need to build a consistent microscopic theoretical framework unifying the description of bulk properties, nuclear excitations and reactions.

Light nuclei play a particular role in low-energy nuclear physics. They exhibit several peculiar features that have been put into evidence experimentally. They can also be described by a large variety of theoretical approaches, starting from the most fundamental ones, the ab initio methods up to those that can be applied all over the nuclear chart. Finally, they mix aspects of nuclear structure and nuclear reactions, with weakly bound states and nearly bound resonances that are particularly hard to describe.

For heavy nuclei, methods based on effective forces (used to build the so called “nuclear energy-density functionals”) have made huge progress, thanks to theoretical and computational advances. These methods also need stringent experimental tests in order to improve the predictive power of the theory. They are complemented by symmetry dictated approaches that both identify and predict the development of simple patterns in complex nuclei. The identification of simple patterns is possible only with systematic investigations contributing to the unraveling of fascinating aspects of the nuclear many-body system.

The availability of extended asymmetric nucleonic matter in different forms and conditions will be the basic ground for exciting research and technical developments driving nuclear physics in the coming years,



## 4.3.2 Theoretical Aspects

### Ab Initio methods

The conceptual foundation of nuclear structure theory is low-energy QCD, which describes the structure of nucleons and their mutual interaction. Over the past decade nuclear structure theory has started to exploit the link to QCD in a quantitative way. Using the tools of Effective Field Theory (EFT) based on the symmetries and the relevant degrees of freedom of QCD in the low-energy regime, consistent Hamiltonians for many-nucleon problems have been constructed (see “Hadron Physics”, page 62).

The ab initio methods that are developed for nuclear spectroscopy provide crucial information on the properties of those interactions and allow for high precision predictions of nuclear observables. Beyond the lightest

nuclei the No-Core Shell Model (NCSM) was successfully employed for the study of ground and excited states using two- plus three-nucleon interactions from EFT. The agreement of these results with experimental data has demonstrated the potential of EFT interactions for precision studies of light nuclei. However, such calculations pose an enormous computational challenge and rely on supercomputer resources.

Powerful schemes have been proposed that allow for a consistent transformation of the nuclear Hamiltonian including three-body interactions, e.g., through renormalization group techniques. The resulting soft interactions form a universal starting point for QCD-based nuclear structure studies in exact and approximate many-body schemes.

The range of applications of ab initio many-body methods is rapidly extending to heavier nuclei. Significant progress has been made in the study of ground states

#### Box 1. Theory and experiment

Modern approaches in nuclear theory aim at an ab-initio understanding of nuclear structure and reactions. Realistic effective interactions emerge from chiral interactions with 2- and 3-body forces. Many-body methods have lead to a consistent microscopic description of light nuclei using nucleons as degrees of freedom. These yield shell structure, clusters, halos, resonances, capture and transfer reactions and scattering states in a unified picture. The obtained understanding can be tested by experiments, which probe excitation for instance spectra, electromagnetic and weak transitions, densities, form factors, spectroscopic amplitudes.

A recent example comes from isotope shift measurements of drip-line nuclei using collinear laser spectroscopy. Precise and model independent measurements of charge radii, magnetic and quadrupole moments provide important information of the wave functions.

Sudden changes in the charge radii along an isotopic change are related to changes in the nuclear structure. The neon isotopes provide a particular interesting example. The experimental charge radii measured at ISOLDE are compared with microscopic structure calculations using the Fermionic Molecular Dynamics (FMD) approach. FMD uses a Gaussian wave-packet basis and allows to describe nuclei with halos and clustering. The two-proton separation energy in  $^{17}\text{Ne}$  is only 0.93 MeV and the structure is understood as an  $^{15}\text{O}$  core and two protons in  $s^2$  or  $d^2$  configurations. The large charge radius in  $^{17}\text{Ne}$  is caused by a large  $s^2$  component of about 42%. In  $^{18}\text{Ne}$  the charge radius is

smaller due to a smaller  $s^2$  component in the wave function. In  $^{19}\text{Ne}$  and  $^{20}\text{Ne}$  the charge radii increase again due to clustering in the ground state wave function.

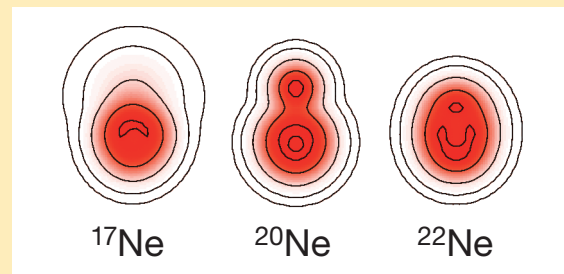

Distributions of dominant FMD configurations indicating an extended two-proton wave function in  $^{17}\text{Ne}$  and  $\alpha$ -clustering in  $^{20}\text{Ne}$ .

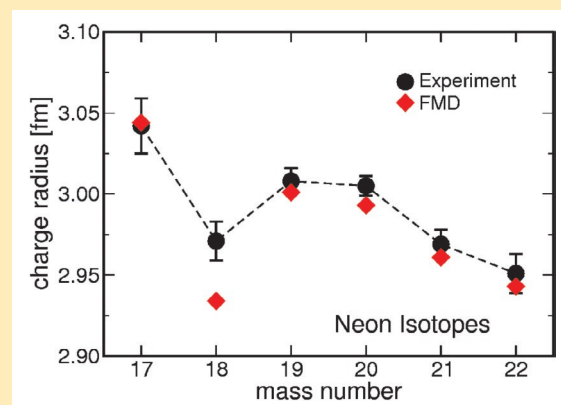

## 4.3 Nuclear Structure and Dynamics

---

of closed-shell nuclei within coupled-cluster theory, using bare or transformed EFT interactions. The range of NCSM calculations regarding model-space size and particle number has been extended, not only through computational advances but also through conceptual developments, such as adaptive model space truncations.

The use of transformed interactions in a variety of approximate many-body schemes, such as variational or perturbative methods, provides valuable information on the properties of QCD-based interactions for nuclei beyond the reach of exact ab initio calculations. Specialized many-body methods for the description of cluster and halo structures, e.g., Fermionic Molecular Dynamics (FMD), provide insight into phenomena that cannot be described adequately in other methods.

The gap between nuclear structure and ab initio nuclear reaction theory is being bridged for systems of increasing complexity. Methods connecting the powerful bound-state techniques discussed above with the description of unbound and scattering states, such as the Lorentz integral transform or the resonating group method, have extended the domain of ab initio reaction studies to systems significantly beyond the reach of traditional few-body approaches (see “Reactions”, page 109).

Together, exact and approximate ab initio methods give access to a wealth of nuclear structure observables based on the same Hamiltonian. The comparison with experiment, in particular for the systematic evolution of different observables from stable to exotic isotopes, will provide decisive information on the predictive power and the limitations of QCD-based nuclear interactions.

### Perspectives

During the past few years exciting new avenues have emerged in ab initio nuclear structure theory. Successful first steps have been made and methodological refinements and extensions as well as applications will be on the agenda for the coming years.

Regarding the QCD-based interactions derived within chiral EFT, there are a number of conceptual questions such as proper power counting and regularization schemes and the role of explicit  $\Delta$  degrees of freedom that will be addressed in the near future. Furthermore, the derivation and implementation of the chiral three-body interaction at next-to-next-to-next-to-leading order needs to be completed. There are also questions as how to combine the EFT description of the interaction with a consistent many-body framework as well as how to connect EFT-based energy density functionals and Hamiltonians. In the sector of unitary and renormalization group trans-

formations of the Hamiltonian, further improvements regarding the choice of the transformation and the inclusion and treatment of three-body contributions are needed. Detailed benchmarks of transformed interactions in finite nuclei and nuclear matter using ab initio methods are required. The comparison to experimental data for light nuclei will provide a rigorous assessment of the quality of QCD-based Hamiltonians.

A major task for many-body methods is the systematic inclusion of two- plus three-nucleon interactions, be it bare or transformed, for a wide array of nuclear structure applications. Given the tremendous computational effort associated with a full implementation of three-body forces, approximate schemes have to be considered. Further exact ab initio many-body methods have to be extended for using QCD-based non-local interactions, most notably Green’s Function or Auxiliary Field Monte Carlo methods. Approximate many-body schemes using the same QCD-based interactions will be refined and applied for ab initio nuclear structure calculations beyond the domain of the exact approaches.

In the coming decade QCD-based ab initio methods will make decisive steps towards their major goals:

- (i) To provide precise ab initio predictions for structure and reactions of exotic nuclei that help to guide and to interpret experiments.
- (ii) To yield information on the properties and degrees of freedom of QCD that are relevant for the understanding of the plethora of nuclear structure phenomena.
- (iii) To establish rigorous benchmarks for other nuclear structure approaches, e.g. energy density functional methods that eventually give access to the whole nuclear chart.

### Shell model

The Shell Model (SM) is a highly successful configuration interaction approach for the microscopic description of the structure of the nucleus. It fills the gap between ab initio methods applicable to light nuclei and energy density functional approaches which are the best adapted for heavy nuclei. The SM is based on an effective interaction acting within a limited model space of valence nucleons. The computational requirements of the SM are heavy and the applicability of the method relies on the availability of large-scale computational resources.

The progress made in the last years has permitted the configuration spaces tractable by the SM to be extended considerably and as a consequence the nuclei that can be studied. The SM plays also an important role in the study of weakly bound and open systems when combined with a proper treatment of resonant states and of

the continuum, as done, e.g., in the Gamow shell model. The introduction of Monte Carlo (MC) techniques has also permitted the domain of SM studies to be extended to heavier nuclei.

## Perspectives

One can expect that the size of the model spaces that can be handled by the SM will continue to increase in the coming years, thanks to computational and to conceptual developments. This will make this method one of the main tools to understand the physics of medium mass nuclei far from stability. Much progress should also be made in the coming years on the derivation of effective interactions well suited for the SM in a given model space. Such derivations will benefit from the developments that are made for ab initio methods and should ultimately provide a link between shell model and QCD-based Hamiltonians. They will greatly benefit from overlap between the applications that can be handled by both approaches.

The SM also provides the correlated nuclear wave functions that are needed for the description of the nuclear weak processes, either the well established ones, as the  $\beta$  decays, or the hypothetical ones, linked to new fundamental physics, like the neutrinoless double  $\beta$  decay. The modeling of the interaction of dark matter particles with nuclei will also demand precise nuclear wave functions for medium-heavy nuclei. Not least, the SM calculations can provide the microscopic input needed to model many astrophysical processes as for instance, supernova explosions and the paths of nucleosynthesis.

## Energy density functional methods

The spectra of medium-heavy and heavy nuclei display a rich variety of single-particle and collective phenomena. Their simultaneous description requires large configuration spaces that exceed what can be numerically handled in ab-initio methods and in the interacting shell model. The family of microscopic approaches based on nuclear Energy Density Functionals (EDF) provides a complete and accurate description of ground-state properties and characteristic excitations over the whole nuclide chart. Currently no other method achieves comparable accuracy at the same computational cost.

Although EDF methods based on effective interactions have extensively been used on the self-consistent mean-field level for more than three decades, this framework has more recently been reinterpreted as the nuclear analogue of density functional theory. Nuclear EDF models coexist on two distinct levels. On the first one a single

product state provides the density matrix that enters the EDF. The short-ranged in-medium correlations are integrated out into an energy functional that is formulated either through a systematic expansion in local densities and currents representing distributions of matter, spins, momentum and kinetic energy and their derivatives, or through a folding with finite-range form factors, and that in combination with an expansion in powers of nucleon densities. Both relativistic and non-relativistic realizations are employed in studies of nuclear matter and finite nuclei. Correlations are incorporated through breaking of symmetries of the exact Hamiltonian. On the second level, often called “beyond mean-field approach”, the many-body energy takes the form of a functional of all transition density matrices that can be constructed from a specific set of product states. This set is chosen to restore symmetries broken by a single product state or (and) to perform a mixing of configurations that correspond to specific collective modes using, for instance, the (Q)RPA or the generator coordinate method. The latter includes correlations related to finite-size fluctuations in a collective degree of freedom, and can be also used to restore selection rules that are crucial for spectroscopic observables. Energy functionals have so far been constructed mostly phenomenologically, with typically about 10 parameters adjusted to reproduce empirical properties of symmetric and asymmetric nuclear matter, and bulk properties of simple, spherical and stable nuclei.

The most remarkable achievements in the last years include the development of microscopic mass models, first systematic large-scale structure calculations that include long-range correlations associated with large-amplitude vibrational motion and with the restoration

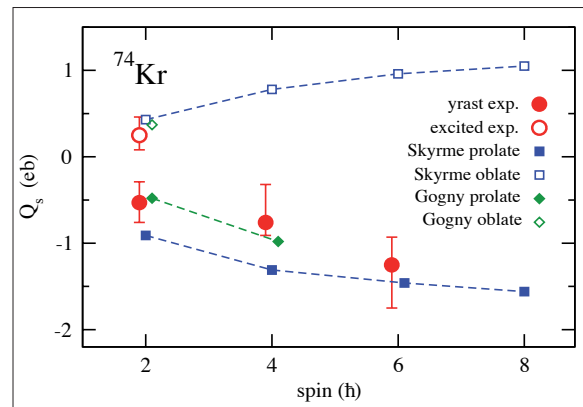

**Figure 1.** Spectroscopic quadrupole moments of shape-coexisting states in radioactive  $^{74}\text{Kr}$  have been extracted by employing  $^{74}\text{Kr}$  RIB from the SPIRAL facility at GANIL. Such direct measures of nuclear shapes represent stringent tests for theoretical models beyond the mean-field approach and energy density functionals.

## 4.3 Nuclear Structure and Dynamics

---

of broken symmetries, the description of phenomena related to the evolution of shell structure in nuclei far from stability, including new regions of deformation, shape coexistence and shape phase transitions, applications to nuclear reactions and fission, predictions of exotic modes of multipole response in neutron-rich nuclei, advances in the correct treatment of the continuum, and accurate global microscopic calculations of the nuclear input for astrophysical applications.

### Perspectives

The main goal of the EDF approach to nuclear structure in the next decade will be the construction of a consistent microscopic framework that describes ground-state properties, nuclear excitations and reactions at a level of accuracy comparable with experimental results, and provide reliable predictions for systems very far from stability, including data for astrophysical applications that are not accessible in experiments.

Many recent studies have demonstrated that none of the existing effective interactions or energy density functionals provides the flexibility needed for a complete and accurate description of the large body of nuclear structure data. It seems mandatory to include higher-order terms, e.g. more complex density functionals or higher-order momentum dependences, and three-body terms, and to identify a hierarchy that can be used as guiding principle. A second open question is the reliability of extrapolations far from the regions of the nuclide chart where the parameters of the EDF have been adjusted. Both issues call for the development of controlled approximations that will establish a qualitative and quantitative connection of the nuclear EDF framework with first principles of the N-body problem and low-energy QCD in the spirit of EFT, with the ultimate goal of limiting phenomenology to the final fine-tuning of the EDF. This would also create a link to similar efforts currently being made in other branches of nuclear structure, and open the road towards the construction of a coherent set of methods for low-energy nuclear physics, each adapted to the relevant degrees of freedom and the complexity of a given nuclear system.

The second challenge is the systematic simultaneous treatment of correlations related to restoration of broken symmetries and fluctuations in collective coordinates. The rapid expansion of available computing resources allows for their explicit treatment in an unprecedented manner. In order to enable EDF-based models to make detailed predictions of excitation spectra and electromagnetic transition rates in medium-heavy and heavy nuclei with arbitrary shapes and/or characterized by soft potential energy surfaces, it is important to develop accurate and efficient algorithms that perform the full

restoration of symmetries broken by the static nuclear mean field (translational, rotational, particle number) and take into account fluctuations around the mean-field minimum for very general shapes.

Third, it would be desirable to establish a connection to reaction theory that overcomes the limitations of existing time-dependent mean-field theory and microscopic optical models, aiming at a unified framework for the description of structure and reactions of complex heavy nuclei.

### Symmetries in nuclei and phase transitions

One fundamental goal of nuclear structure physics is to evidence regularities and simple features of nuclear spectra, providing a comprehensive understanding of the origin of such regularities in the complex nuclear many-body systems. These features are known to be associated with the so-called dynamical symmetries, which include both symmetries of the mean field and symmetries of the residual interactions among the particles, and which are characterized by definite underlying algebraic structures. The interest in recent years has been focused on the search for new dynamical symmetries (so-called critical point symmetries), associated with the critical points characterizing the quantum phase transitions connecting mass regions with different behavior along chains of isotopes (or isotones) and named after the corresponding group structure (E(5), X(5), etc). Possible candidates have been found in different mass regions, with results not always conclusive, but most of the other suggested candidates lie outside the stability region and will be accessible only by the new radioactive beam facilities. From the theoretical side, different approaches have been utilized to describe the phase transitional behavior. The original seminal papers have used the collective framework based on the Bohr Hamiltonian. Alternative approaches have extensively used the Interacting Boson Model while other approaches have more recently investigated phase transitions from a more microscopic point of view, as those based on mean field theories.

### Perspectives

The issue of quantum phase transitions in nuclei is far from being fully explored and great steps are expected in the coming years on the theory side. The major extensions will concern the explicit treatment of the nucleus as a fluid with two components (protons and neutrons) the treatment of excited states, a generalization to odd-even systems (treated as a mixture of bosons and fermions).



---

Each of these extensions will open the possibilities of new phase transitions.

New results are also expected from the microscopic approaches based on EDF methods. These should allow a deeper understanding of the origin and the nature of the nuclear shape phase transitions. In particular, the richer scenario offered by these microscopic approaches with respect to more schematic boson models will lead to more realistic predictions for the position of the critical nuclei in the mass table

## Reactions

The availability of low- and high-energy radioactive beams and, in particular the discovery of halo-nuclei, has brought out a renewed interest in the modeling of nuclear reactions. To take into account the complexity of the many-body problem, current approaches to reaction theory involve different approximations whose validity needs to be checked, in particular when applied to exotic light nuclei.

In the last few years important advances include:

- (a) the description of very-low energy subbarrier fusion processes that should provide information on the inner part of the ion-ion potential;
- (b) general parameterizations of the ion-ion optical potentials aimed at the description of both fusion and quasielastic processes for stable and unstable systems;
- (c) a consistent coupled-channel microscopic formalism for the description of multinucleon transfer reactions, with the intent of clarifying the smooth transition from grazing to deep-inelastic processes;
- (d) massive calculations of elastic and break-up processes involving exotic halo nuclei, exploiting coupled-channels approaches based on continuum discretization;
- (e) novel approaches based on the *ab initio* inclusion of the halo few-body nature into the reaction formalism;
- (f) extensions to the explicit treatment of four-body channels (as in break-up reactions involving two-neutron halo nuclei).

## Perspectives

There are two major issues in any reaction approach: first, to ensure that sufficiently detailed microscopic structure information of the interacting nuclei is incorporated (via optical potentials, form-factors, spectroscopic factors, etc.) and, second, a proper treatment of the relevant dynamics. These two aspects are often intertwined and need to be carefully addressed.

Within this general framework several topics can be singled out for future work. In particular:

- (a) a more extended use of microscopic models for the excitation (via different probes as Coulomb, inelastic, charge-exchange, transfer, etc) of different collective and non-collective modes (e.g. dipole pigmy states).
- (b) a consistent description of the interplay between continuum and many-body correlations, for systems with unbound ground states and above threshold for weakly-bound systems
- (c) a further clarification of the reaction mechanism for two- and multiparticle transfer reactions, in relation with the role of pairing-like interactions (in both isospin  $T=0$  and  $T=1$  channels)
- (d) a systematic comparison between different scattering approaches with similar structure and dynamical inputs, in order to clarify the validity of different approximation schemes
- (e) the development of a reliable framework for the study of quasi-free breakup, that will yield information on the wave function of the struck particle, in particular at high energies at which the scattering framework is expected to become simpler.

In addition to developments within the conventional models, promising results have been obtained employing other approaches, in some cases novel, and in other cases revitalized after decades of obsolescence (such as TDHF mean-field calculations for reactions). In the case of reactions involving light ions, in particular, much is expected from the extension of *ab initio* shell-model calculations to reactions, as well as from structure models based on the cluster approach.

## Toward a unified description of nuclear structure and reactions

Nuclear theory is rapidly evolving from studies of nuclei close to the valley of beta-stability towards a description of vast regions of short-lived and exotic nuclei far from stability and at the nucleon drip-lines. Such an expansion imposes stringent constraints on microscopic structure and reaction models that are being developed. These mainly concern the model space that must take into account the coupling between bound states and the continuum, and the construction of effective interactions that can be used all over the nuclear chart. This overview of the various aspects of modern nuclear theory has focused on the current status and perspectives of our understanding and modelling of low-energy nuclear physics.

## 4.3 Nuclear Structure and Dynamics

Ab-initio methods, large-scale Shell-Model (SM) calculations, Energy Density Functional (EDF) methods, and symmetry-dictated models, present complementary approaches to the nuclear many-body problem. A successful description of the rich nuclear phenomenology must, of course, ultimately be related to the underlying fundamental theory of strong interactions. Ab-initio methods are being developed to establish this link on a quantitative level and, in addition, it will be important to extend the domain of applicability of these approaches toward heavier nuclei. Large-scale SM methods and EDF-based models currently provide the most accurate and complete set of tools for a systematic description and interpretation of data that will be produced by the next generation of experimental facilities, focused on the physics of nuclei far from stability. Symmetry-dictated approaches provide insight on how simple patterns emerge in the structure of complex nuclei. The goal for the next decade will be to develop a microscopic description of nuclear structure and reaction phenomena that can be extrapolated very far from beta-stability, and simultaneously provide reliable error estimates. The aim will also be to firmly establish the microscopic foundation of low-energy nuclear theory. This will only be possible by methodically developing and exploring the various interdependent theoretical and computational approaches described in this overview.

### 4.3.3 Onset of Complexity

#### Linking nucleons with nuclei

The domain of light nuclei is the natural testing ground for linking nucleons and sub-nucleon degrees of freedom with complex nuclei. Thus the related experiments should provide precise data to constrain the modern ab-initio calculations. Not only energies and spin-parities of states, but also electro-weak transition rates, spectroscopic factors, ground state moments, radii and masses are needed. Furthermore, it is crucial to investigate the role of the continuum, both concerning reaction mechanism and structure.

#### Weakly bound and unbound states

A large part of the motion of exotic systems at the very limits of nucleonic binding is in classically forbidden regions and therefore their properties are profoundly influenced by both the continuum and many-body correlations. The importance of the continuum for the description of resonances is obvious. Weakly bound states cannot be described within the closed quantum system formalism. A consistent description of the inter-

play between scattering states, resonances and bound states requires an open quantum system formulation of the nuclear many-body problem.

The main challenges in the coming years will be

- (i) to address the structure/reaction aspects in long chains of isotopes,
- (ii) to handle very large model spaces and to introduce a correct treatment of continuum states in ab-initio many-body framework,
- (iii) to develop microscopic reaction theories for the description of complex reactions with multi-nucleon continuum and/or more than two fragments in the final state.

In recent years, the availability of RIBs and associated new equipment has enabled studies of continuum properties of unbound and weakly bound nuclei through transfer or knock-out reactions. Open questions arising from these experiments are the role of resonances and non-resonant continuum as well as shell structure changes beyond the drip lines.

The observed systems beyond the drip-lines are so far restricted to the light masses, such as  ${}^5,7\text{H}$ ,  ${}^{7,9,10}\text{He}$  and  ${}^{10,12,13}\text{Li}$  (Figure 2) on the neutron-rich side, or  ${}^{10,11}\text{N}$  and  ${}^{12}\text{O}$  on the neutron-deficient side. The existing results are hampered by low statistics, resolution and/or selectivity very often leading to conflicting conclusions on the properties of more loosely bound systems. Higher RIB intensities and next generation instrumentation are required to clarify the situation and to explore the neutron drip-line towards heavier elements.

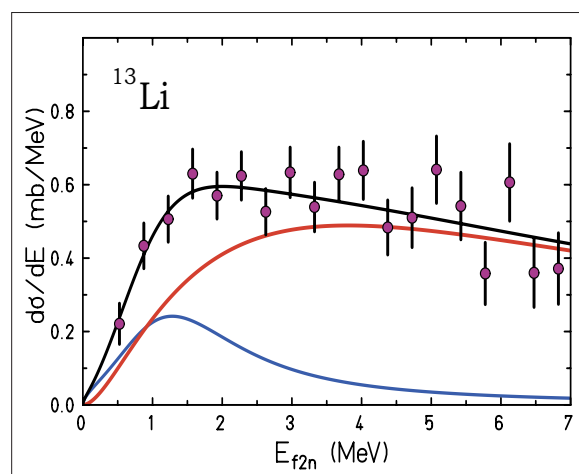

**Figure 2.** The unbound  ${}^{13}\text{Li}$  was observed after nucleon knock-out reactions at relativistic energies with  ${}^{14}\text{Be}$  impinging on a liquid hydrogen target. Data are from the ALADIN+LAND setup at GSI. The  ${}^{11}\text{Li}+2n$  data demonstrate components that cannot be attributed to initial correlations in  ${}^{14}\text{Be}$  (red line) and thus give the first indication for the existence of a  ${}^{13}\text{Li}$  resonance at 1.47 MeV (blue line)

---

## Halos, clusters and few-body correlations

A specific challenge in light nuclei is to find the correct degrees of freedom for weakly bound systems, in order to describe structures such as halos, alpha clusters and nuclear molecules. Cluster structures in many-body states manifest themselves close to cluster channel thresholds due to the coupling of a given many-body state with the decay channel. Thus halos are only particular examples of a more general clustering phenomenon. This example illustrates why one has to consider many-body states in the extended configuration space including decay channels.

Since the experimental discovery of the halo structure in the mid 80's, detailed studies have been performed to reach a deeper understanding of the ground-state wave function of halo nuclei and in particular of neutron correlations in the case of 2-neutron halo nuclei, such as  ${}^6\text{He}$  and  ${}^{11}\text{Li}$ . In the case of the benchmark drip-line system  ${}^{11}\text{Li}$ , the results indicate large ground-state configuration mixing and strong correlations between the two halo neutrons. Recently, evidence for low-lying and some of the high-lying excited states in  ${}^6\text{He}$  has been found. Experiments in the next years should reveal a clear final picture of the most studied halo nuclei and to allow the investigation of heavier candidates for which data are still scarce or which are presently out of reach.

The envisaged studies of these exotic structures in the coming decade involve cluster and single-widths, knock-out or transfer reactions, quasi-free and electron scattering. Studies of exotic cluster-decay modes are needed to investigate which sub-clusters are possible far from stability and/or at high excitation energies.

It is challenging to obtain cluster correlations in ab-initio approaches such as the no-core shell model. The Fermionic Molecular Dynamics (FMD) or Antisymmetrised Molecular Dynamics (AMD) approaches are powerful alternatives for studying this aspect of nuclear structure.

## Specific instrumentation for studies of exotic light nuclei

The toolbox for studying the lightest exotic nuclei has to be extremely diverse. Since most experiments are on the limit of what is possible both concerning ion production and detection, an integral approach is often necessary where the accelerator and separation facilities are parts of the experimental set-up. In addition to the generic state-of-the-art detection systems for charged particles and gamma rays, systems specific to studies of light nuclei are active targets for low-momentum transfer experiments as well as high-efficiency, high-granularity neutron detectors for reaction and neutron-decay stud-

ies. A wealth of spectroscopic information has become available by the advancement of high-granularity detectors for charged particles; the potential for similar studies through neutrons is at least as large, but as of yet has hardly been possible to address.

## 4.3.4 Shell Structure and the Isospin Degree of Freedom

### Changing shell structure

The modification of shell gaps far from stability raises doubts about one of the firmest paradigms of nuclear structure – the universality of magic numbers throughout the nuclear chart. Nuclei are more stable and difficult to excite at particular neutron or proton numbers, 8, 20, 28, 50... the so-called magic numbers. In recent years, evidence has surfaced pointing to changing shell structure with a varying number of protons and/or neutrons. These findings furnish a stringent test for modern nuclear structure models and have important astrophysical implications, in particular for the understanding of the r-process. From a theoretical point of view, the reasons for this shell evolution are not well established and different scenarios are under consideration; variations in the mean field when approaching the neutron drip-line as well as specific components (pairing, tensor interaction...) in the residual interaction, to name a few.

### Vanishing and new shell gaps in light nuclei

These specific phenomena have a vast influence on the predictions of nuclear properties far from stability. A classical example is the parity inversion of the  ${}^{11}\text{Be}$  ground state, which indicates that the shell gap between the p and sd shells has disappeared. In this case the  $1s_{1/2}$  orbital has become the intruder ground state, leading to the vanishing of the  $N=8$  magic number. A similar phenomenon has been observed in the resonant nucleus  ${}^{12}\text{O}$ , proving that such shell evolution occurs also on the proton rich side of the valley of stability and therefore is strongly linked to shell model n and p occupancy. Furthermore, the magic character of the neutron number  $N=20$  appears to have vanished in the exotic nucleus  ${}^{32}\text{Mg}$  ( $Z=12$ ). Such an “island of inversion” has also been identified around  $N=28$  (see Box 2). Recently shell changes have been seen below  $Z=28$  in neutron-rich Co isotopes, and appear to occur also for Ca, Ti isotopes with  $N\sim 34$  and in Cu isotopes approaching  $N=50$ . It had been widely speculated that, besides the doubly magic  ${}^{16}\text{O}$  ( $Z=N=8$ ), the oxygen isotope with 20

## 4.3 Nuclear Structure and Dynamics

### Box 2. Changing magic numbers

The monopole part of the effective nucleon-nucleon force induces drastic changes in the single particle energies, resulting in changes in the magic numbers in nuclei far from stability. The strong p-n interaction between spin-orbit partners (right figure) is essential for these changes.

It results in a spin  $\frac{1}{2}$  ground state in  $^{31}\text{Mg}$ , dominated by neutron excitations across a reduced  $N=20$  gap, evidenced by the magnetic moment measured at ISOLDE.

It leads to a disappearing  $N=28$  shell gap, seen in  $2^+$  energies in neutron-rich Si isotopes measured at GANIL.

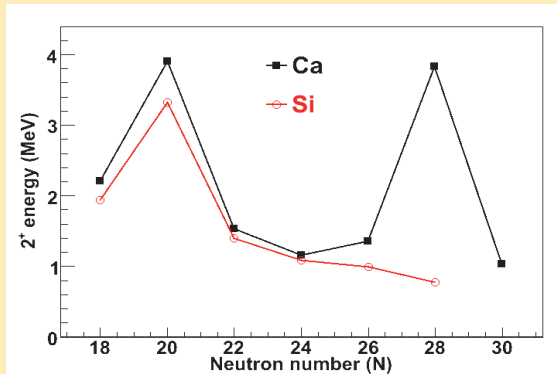

In the future, transfer reactions will provide a powerful tool to map out single particle energies throughout the nuclear chart at HIE-ISOLDE and SPIRAL2.

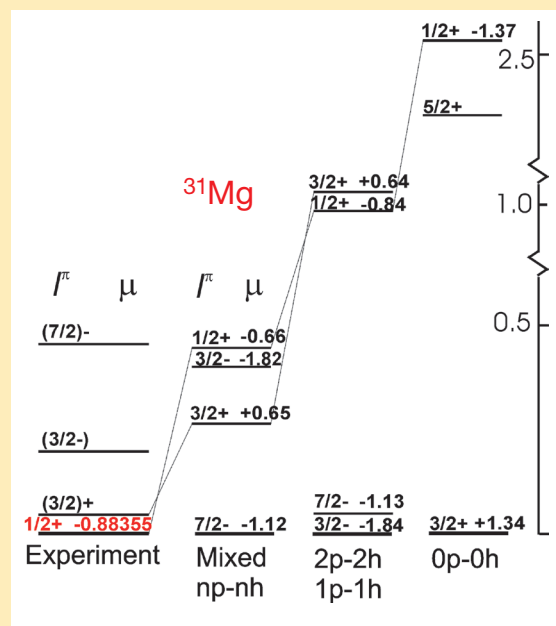
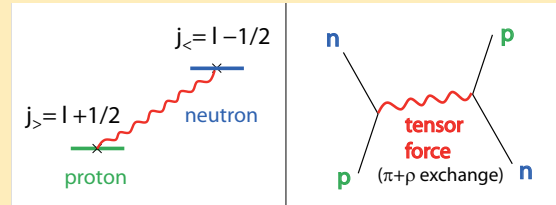

neutrons would be particularly stable, but experiments found that this nucleus,  $^{28}\text{O}$ , is not even bound. On the other hand, measurements have revealed that  $^{24}\text{O}$  is doubly magic indicating that new magic numbers develop far from stability.

Future research programmes with RIBs will use various reactions to investigate the effects of the isospin dependence of the mean field and of the long- and short-range correlations in exotic nuclei. An example of a future programme is the single particle occupancy near the 'normal' neutron shell closures from  $N=8$  to  $N=126$  as a function of  $Z$ , which can be investigated through transfer reactions. This requires the widest range of nuclear beams with energies of  $\sim 10$  MeV/u. HIE-ISOLDE and the upgraded SPIRAL facility will provide a wide range of ISOL beams, while intense beams of neutron-rich fission-fragments will be accelerated using SPIRAL2 and SPES. There will also be possibilities of such studies at the EXL facility at FAIR.

New experimental set ups tailored to measure simultaneously and with increased efficiency particles and gamma-rays will largely increase the sensitivity and resolution of such studies. Radioactive (triton) and polarized targets will complete the array of equipment available to the experimentalists.

The next decade should see the mapping of single particle structures throughout the nuclear chart with a precision approaching that known for stable nuclei today.

### Proton-neutron symmetric nuclear matter and the proton drip-line

Isospin symmetry is a property of the strong interaction. In observables such as energies and masses this symmetry cannot manifest fully due to the presence of the electromagnetic interaction, which by its nature does not have this symmetry.



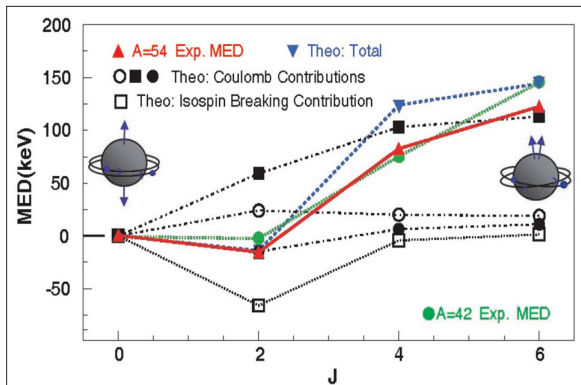

**Figure 3.** Mirror Energy Differences (MED), i.e. differences in excitation energy for analogue states in mirror nuclei, for the heaviest known mass triplet,  $A=54$  (red line), extracted from experiments employing the EUROBALL and more recently the RISING spectrometers. To illustrate the cross-conjugate symmetry, within the shell, MEDs of mass  $A=42$  are shown as well (green line). MEDs are originated by isospin breaking interactions in the nucleus. Theoretical description (blue line), with large-scale SM calculations, comprises the single particle, radial and multipole (alignment) Coulomb contributions, as well as a sizeable additional isospin breaking contribution not understood hitherto (black lines).

Consequently, pairs of nuclei with mirroring values of  $N$  and  $Z$  (across the  $N=Z$  line) are expected to have excitations differing only by the Coulomb contributions (mirror energy). Precise measurements of mirror energies thus provide a stringent test of the effective nuclear interaction used in shell-model calculations. Therefore, there is a need to measure mirror pairs with large isospin quantum numbers to maximise the difference in the Coulomb contributions. These studies will only be possible using the next generation RIB facilities. The challenge is to measure mirror energies near or even beyond the proton drip-line and to investigate if shape changes and shape coexistence could play a role in the differences between isobaric multiplets in medium-mass nuclei. Therefore, instrumentation combining gamma-ray tracking and light charged-particle detector arrays is of paramount importance.

### Limits of existence in proton-rich nuclei and $^{100}\text{Sn}$

One of the most relevant questions in nuclear physics concerns the limits of existence of nuclei, in terms of the number of protons and neutrons. Experimental as well as theoretical efforts are continuously made to map the drip-line. Presently the one-proton drip-line is known up to mass  $A\sim 180$ , whereas the two-proton drip-line is only known up to  $A=54$ .

One- and two-proton emitters are spectacular examples of open quantum systems, which allow the study of coupling between bound nuclear states and the continuum. Furthermore, proton emitters also provide a wealth of spectroscopic information, testing the validity of nuclear models beyond the drip line. The dynamics of the two-proton radioactivity provides an insight into the pairing interaction and Josephson tunnelling in nuclear matter. After the recent observation of the ground state two-proton decay of  $^{45}\text{Fe}$ , the understanding of the physics involved requires more detailed data on the two-proton decay of  $^{48}\text{Ni}$  and  $^{54}\text{Zn}$  as well as investigations of heavier candidates,  $^{59}\text{Ge}$ ,  $^{63}\text{Se}$ , and  $^{67}\text{Kr}$ . In addition to the total decay energy and the partial half-life, the energy sharing between the two protons and in particular the angle between the protons should be measured.

Prompt particle decay in competition with gamma decay from excited or isomeric states is a rare phenomenon. It was identified in the  $A\sim 60$  region and explained in some cases, as a consequence of an abrupt shape transition in nuclei with a limited Coulomb barrier. While the prompt proton decay has been known for more than a decade, recently the prompt emission of alpha particles was identified for  $^{58}\text{Ni}$ . The nuclear structure information extracted from the analysis of this process is far from being understood and requires experimental as well as theoretical efforts.

The most relevant nucleus lying at the proton drip-line is the  $N=Z=50$  nucleus  $^{100}\text{Sn}$ . It is expected that any collective phenomena present in this nucleus will be reinforced by the coherent contribution of protons and neutrons. The information regarding the structure of this nucleus is very scarce. More detailed data will provide an insight into what extent shell gaps, collectivity or low-lying vibrational states are preserved.

The studies of charged particle decay from isomeric or ground states will require efficient arrays of high resolution charged-particle detectors with discrimination capabilities, used in conjunction with large gamma-ray detector arrays. The investigation of rare two-proton decay requires pictures of individual decay events obtained by employing novel imaging time-projection-chambers (Figure 4).

Studies of the prompt particle decay can be extended to heavy nuclei by employing the recoil-decay tagging method. The investigation of delayed one- and two-proton emitters is still limited by the flight time through the separator. One ambitious experimental goal is to fill the gap between the prompt and the several hundred ns delayed emission.

## 4.3 Nuclear Structure and Dynamics

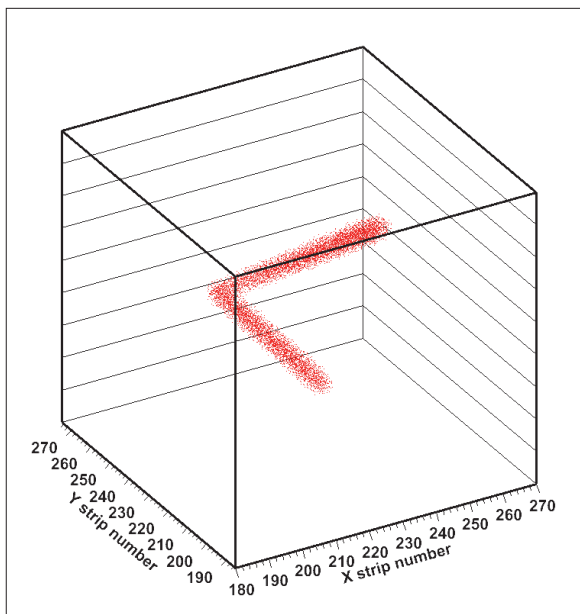

Figure 4. Two-proton emission event from  $^{45}\text{Fe}$  as detected and reconstructed with a time-projection chamber.

### Proton-neutron pairing and pairing at high isospin values

Pairing is an important ingredient of the effective nuclear forces and is essential for understanding the structure of nuclei. The influence of pairing between identical nucleons on nuclear properties has been explored experimentally both via mass measurements and spectroscopic and two-nucleon transfer reaction studies and is theoretically well understood.

Nuclei with  $N=Z$  exhibit an additional symmetry, related to the similarity of proton (p) and neutron (n) wave functions at the Fermi surface. In this framework protons and neutrons may form Cooper pairs. While identical nucleon pairing is only active in the isospin  $T=1$  channel, n-p pairing can exist both in the isovector  $T=1$  and isoscalar  $T=0$  states. While the  $T=1$  n-p pairing strength is well defined by isospin symmetry, the characteristics of  $T=0$ , deuteron-like pairing is largely unknown.

Three experimental approaches are being used to investigate the n-p pairing:

- (i) the study of the collective behaviour, at low and high spin, in  $N=Z$  nuclei,
- (ii) the investigation of ground-state properties (the structure of odd-odd  $N=Z$  nuclei and  $\beta$ -decay to  $N=Z$  daughter nuclei) and
- (iii) the study of two-nucleon transfer reaction cross-sections in inverse kinematics.

The rotational properties of heavy  $N\approx Z$  nuclei such as the band crossing frequencies and the moments of inertia at high spin may be influenced by the different components of the n-p pairing. In addition, pairing effects are stronger in nuclei with high-j valence nucleons, due to the large number of possible pairs. Therefore, the heavier the  $N=Z$  nucleus the larger the n-p pairing effect is expected to be. Recently, it has been suggested that enhancement of collectivity in the vicinity of  $^{100}\text{Sn}$  can probe the increasing importance of isoscalar p-n pairing in heavy  $N=Z$  nuclei. Two-nucleon transfer reaction cross-sections are expected to be enhanced in the presence of strong pairing. The (p, $^3\text{He}$ ) and (d, $\alpha$ ) reactions can give complementary information on the n-p pairing, since the former will be affected both by the  $T=0$  and  $T=1$  interactions, while the latter will only probe the  $T=0$  pairing.

In addition to the intrinsic interest of pairing for nuclear structure, understanding the cooling and rotational properties of neutron stars requires accurate modelling of the pairing gaps in their low density, overwhelmingly neutron-rich crust. The variation of the pairing field with isospin can be approached experimentally through the study of the (p,t) and (t,p) reactions with neutron rich RIBs. A complementary approach, more focused on the study of the pairing effects in nuclear matter, concerns the possible enhancement of pair-transfer cross-sections observed in multi-nucleon transfer processes between heavy nuclear systems. More speculatively, the ( $\alpha$ ,  $^6\text{He}$ ) reaction being very surface peaked may probe more directly pairing properties within the halos or skins.

All three experimental approaches to study n-p pairing will benefit from the availability of new heavy proton-rich RIBs. The availability of neutron-rich RIBs is crucial in the investigation of the neutron pairing in low-density neutron matter.

An unexplored issue is the validity of the degrees of freedom (single particle, pair or even cluster transfer modes), form factors and matrix elements used to describe the multinucleon transfer process in reactions with stable-ion beams when they are applied to RIBs. Theoretical developments in reaction theory, in particular the inclusion of microscopic form factors in DWBA calculations and the detailed treatment of multi-step processes will be a challenge.

## Superheavy elements

The existence of SuperHeavy Elements (SHE) is based on nuclear structure effects. Shell stabilization creates a barrier against spontaneous fission, which would otherwise terminate the periodic table just above  $Z = 100$ . The effect of repulsive Coulomb forces and nuclear attraction delicately balance each other in the region of SHE. Level densities are high and nucleonic orbitals with high and low angular momentum occur close together near the Fermi energy. Small shell gaps may cause shape changes such that nuclear deformed states may coexist. These are the main reasons why nuclear-structure effects play an especially important role in this region. They may also

have a decisive influence on the possibility of producing these nuclei in fusion reactions. Present SHE research goes far beyond synthesis studies. It builds on a large variety of tools and methods, which allow the atomic, nuclear and chemical properties of SHE to be studied.

Highlights of recent work include the synthesis of elements up to Cn ( $Z = 112$ ) and element  $Z = 114$  at GSI. The chemical study of element 108 (Hs) led to the discovery of deformed doubly magic  $^{270}\text{Hs}$ . At Dubna new elements up to  $Z = 118$ , produced in complete fusion reactions of  $^{48}\text{Ca}$  projectiles with radioactive transuranium isotopes as targets, have been reported. They were consistently assigned, but lack direct  $Z$  (and  $A$ ) identification. Further

### Box 3. Superheavy elements

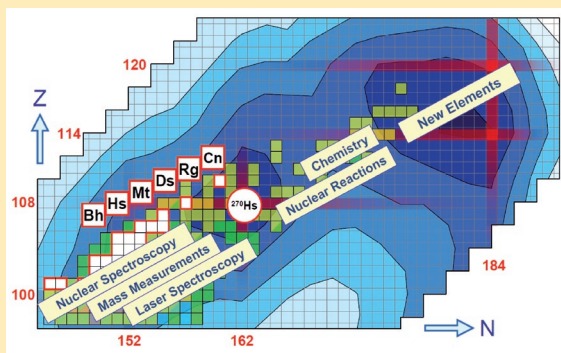

#### New elements

The long-standing quest for superheavy elements (SHE) has led to exciting results during the past decade claiming synthesis of elements up to  $Z = 118$ . Confirmation of these results obtained in Dubna, synthesis of new elements with  $Z > 118$  and to reach the predicted neutron shell closure at  $N = 184$  will be the great challenges for the next decade.

#### Masses and atomic structure

Masses of  $^{252-254}\text{No}$ ,  $^{255}\text{Lr}$  were measured with SHIPTRAP at GSI. The fundamental challenge is to extend these mass measurements to neutron rich long-lived transactinides, which terminate the  $\alpha$ -decay chains starting at  $Z > 113$ , as well as investigating the complex atomic structure of stored super-heavy nuclides by means of laser spectroscopy.

#### Nuclear structure

Transfermium nuclei can be produced with cross-sections of  $> 10\text{nb}$  enabling in-beam and focal-plane studies in tagging experiments. In addition to the ground-state rotational band, bands built on high- $K$

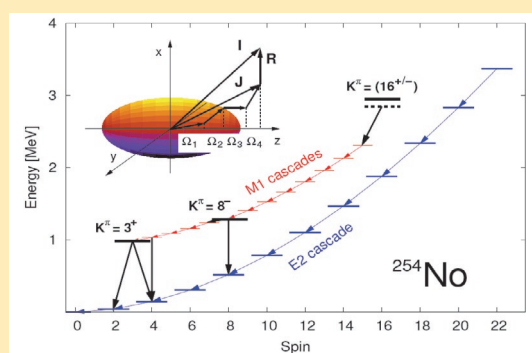

isomers have been observed in  $^{254}\text{No}$  and adjacent nuclei, in experiments carried out at JYFL and GSI.

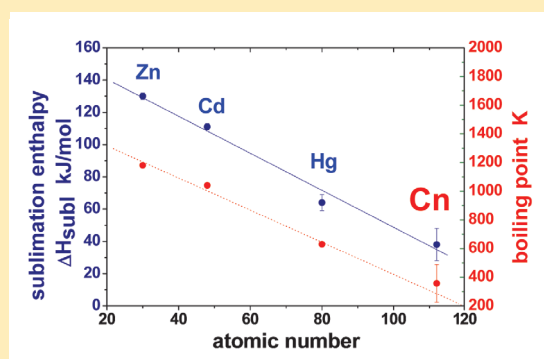

#### Chemistry

Strong relativistic effects on the electronic structure of SHE make them extremely interesting objects for chemical studies. Copernicium (Cn) is a noble metal as its sublimation enthalpy and boiling point follow the trend of the lighter group-12 elements towards high volatility.

## 4.3 Nuclear Structure and Dynamics

steps will be the synthesis of elements with  $Z \geq 119$ , requiring beams heavier than  $^{48}\text{Ca}$ , such as  $^{50}\text{Ti}$ , which is a technical challenge.

Due to the low production cross-sections, understanding of the nuclear reaction mechanism is essential for successful synthesis of SHE. Therefore, investigations of the reaction dynamics are being pursued by studying in detail fusion-evaporation, fusion-fission and quasi-fission excitation functions with specific emphasis on the deformation and the mass ratio of the reaction partners. Recent theoretical studies demonstrate that nuclear transfer reactions may be a unique approach to produce neutron-rich isotopes of SHE, that are, in near future, not reachable by any other means. Complementary physical and chemical methods to separate and to study such nuclei will be developed.

Stringent tests for the various nuclear models used in predicting properties of SHE come from detailed spectroscopic studies of nuclei as close as possible to the SHE region. Research programmes carried out at JYFL, GSI and GANIL study transfermium nuclei in the region of  $^{254}\text{No}$  close to the  $N = 152$  deformed sub-shell gap. These nuclei are the heaviest for which detailed in-beam and decay spectroscopy can be performed by employing modern gamma-ray spectroscopic and tagging techniques. The deformed nature of these nuclei is confirmed by the observation of rotational bands. Non-yrast and K-isomeric states have recently been studied following pioneering work at JYFL, yielding crucial information for comparison to the predictions of various theories. New instruments that allow the simultaneous detection of conversion electrons and gamma-rays are under construction to reach even higher sensitivity.

Systematic trends of nuclear binding energies, shell structure and atomic properties are obtained with mass and laser spectroscopy. The first accurate mass measurements of transfermium nuclei ( $^{252-254}\text{No}$ ,  $^{255}\text{Lr}$ ) were performed at SHIPTRAP at GSI employing the novel hybrid technology of gas stopping after in-flight separation. Developments to carefully probe still heavier nuclei with production rates approaching one atom per day are in progress. Using similar approaches, studies of isotopes of elements up to  $Z = 108$  and of complex atomic structures by means of laser spectroscopy are envisaged.

The location of SHE shell closures can be probed by measuring fission times of produced compound nuclei. Evidence for components with longer fission lifetimes in  $Z = 120$  and  $Z = 124$  compound nuclei was found in an experiment at GANIL using crystal blocking techniques. Developments for more precise fission time measurements are in progress.

Relativistic effects, prominent for the inner electrons of high- $Z$  elements, affect the electronic structure of the outer shells, thus influencing the chemical properties of SHE. Therefore, these may deviate from the systematic ordering in Mendeleev's table. While chemical studies of SHE represent an extraordinary experimental challenge, they provide excellent tests for modern relativistic quantum theory. Present experiments have reached elements up to Hs and element Cn, and will be extended into the element 114 region and beyond. Studies of new types of SHE chemical compounds such as metal-organic ones, formed after pre-separation in a recoil separator like TASCA, will open up a completely new field of SHE chemistry, which yields insights into detailed atomic structure, thus being complementary to spectroscopic methods.

New neutron-rich isotopes of SHE, possibly produced in transfer reactions, may provide important information on  $r$ -process nucleosynthesis in the region of the heaviest elements. Half-life and fission data yield input for recycling of synthesized material into the medium-heavy abundance peaks.

The success of the programme outlined above depends on the availability of high-intensity stable-ion beams and the development of high-power targets and innovative separators. In addition, it is important to have access to the region where decay chains from  $^{48}\text{Ca}$  induced reactions with actinide targets end. The plan within SPIRAL2 is to use the high-intensity stable and neutron-rich beams while at GSI a dedicated cw-linac is proposed as important milestones in this direction.

### 4.3.5 Collective Properties

#### Collective response of nuclei

The nuclear collective responses reveal information on the bulk properties of nuclei and nuclear matter. This response is characterized by the giant resonances of various multipolarities with most of the strength well above the particle separation energy. It is of particular interest to study the collective strength in short-lived nuclei because of the implications in nuclear and astrophysical phenomenology (e.g., nuclear compressibility, asymmetry energy in the nuclear equation of state, deformation and damping mechanisms, and spin modes).

Additional dipole strength observed at low excitation energy close to the particle-separation threshold in neutron-rich nuclei has been associated with a vibration of excess neutrons (neutron skin) against an isospin-saturated core (an example for the unstable  $^{68}\text{Ni}$  nucleus is shown in Figure 5). Coulomb inelastic excitation and



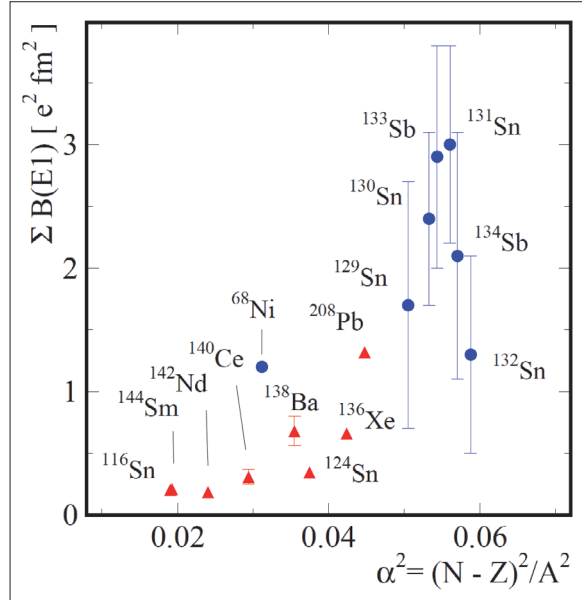
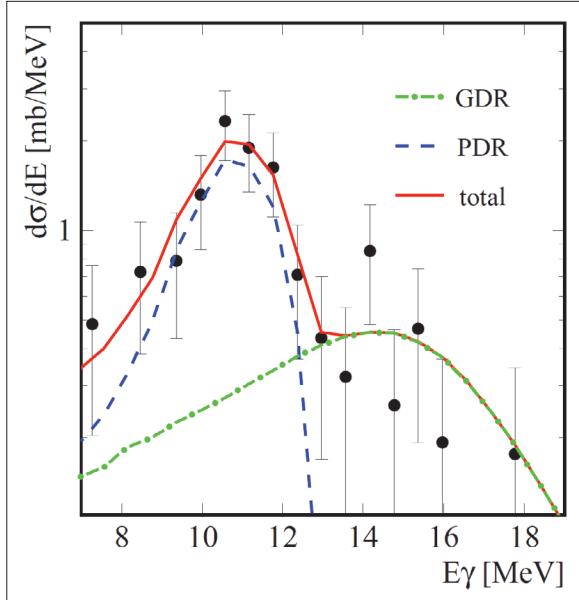
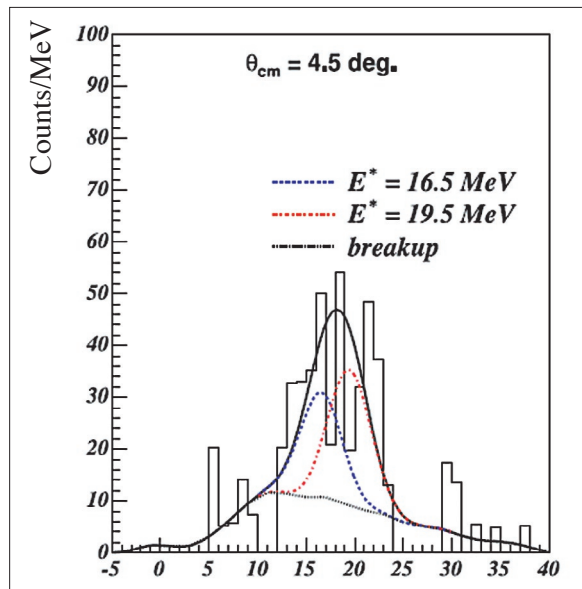

**Figure 5.** Gamma-ray spectrum of the Pygmy Dipole Resonance (PDR) in  $^{68}\text{Ni}$ , measured with the RISING array at GSI (left) and a compilation of integrated low-lying dipole strength in stable and neutron-rich nuclei from S-DALINAC and GSI, respectively, shown as a function of asymmetry.

Coulomb projectile break-up at a few hundred MeV/u are used for these studies. Detailed complementary studies of this new excitation mode known as the Pygmy Dipole Resonance (PDR), can be done in stable nuclei by employing electromagnetic and hadronic probes. The right part of Figure 5 shows a compilation of observed low-lying dipole strength as a function of neutron-proton asymmetry  $\alpha$ .

It is important to understand the nature of the low- and high-energy components of the dipole strength in general. Therefore, studies of its evolution as a function of larger neutron-proton asymmetry, deformation and temperature are called for. A very interesting aspect is the relation of the dipole strength to the density-dependence of the symmetry energy and the neutron-skin thickness. The equation of state (EOS) for asymmetric nuclear matter is particularly important for the understanding and description of neutron-star properties.

The measurement of giant resonances of other multiplicities as well as magnetic excitation modes in unstable nuclei require new experimental techniques, such as those based on light-ion scattering in inverse kinematics. A pilot measurement for the giant monopole excitation, providing information on the nuclear compressibility, was made for the unstable  $^{56}\text{Ni}$  nucleus (Figure 6) using inverse kinematics and the active target MAYA (Figure 12). The key instrumentation to enable major experimental steps towards the understanding



**Figure 6.** Giant quadrupole resonance (16.5 MeV) and giant monopole resonance (19.5 MeV) in  $^{56}\text{Ni}$  induced by the  $^{56}\text{Ni}(d,d')$  reaction at 50 MeV/u in the MAYA active target at GANIL.

of giant resonances in exotic nuclei will be available at FAIR with R<sup>3</sup>B and the storage-ring experiments EXL and ELISE employing hadron and electron scattering, respectively.

## 4.3 Nuclear Structure and Dynamics

### Evolution of nuclear collective properties with spin and temperature

The investigation of nuclear properties as a function of spin and temperature plays a crucial role in the study of nuclear structure beyond the mean field description. Experiments exploring the nucleus at the highest possible spins have shown that a nucleus while spinning faster and faster can undergo several shape changes before terminating in a single-particle like configuration, where the nucleonic spins of all valence nucleons are aligned. In order to produce even higher-spin states the nucleus can regain a collective motion by acquiring more valence nucleons (see box). In this way it is expected to observe new shape phenomena like the long sought hyperdeformation.

Close to the yrast line, the low-lying excited states are characterized by good intrinsic quantum numbers, with decays governed by selection rules. At energies of 6-8

MeV above the yrast line, the increased level density and level mixing lead to the vanishing of the quantum numbers and of the associated symmetries. Further studies of rotational motion in the “warm region” will yield information on the two-body residual interaction that causes the band mixing process, which is the precursor of the chaotic regime, which is fully reached at the neutron separation energy. In the very hot region of  $T > 4$  MeV, close to the liquid-to-gas phase transition, a gradual loss of collective motion in the nucleus is expected.

The realm of high-spin physics is concentrated on a surprisingly small number of nuclei all located on the neutron-deficient side of the valley of stability. With neutron-rich RIBs of highest intensity a new era in high-spin physics is expected as more and more neutron-rich compound nuclei at even higher spins can be explored. In this way long standing theoretical predictions, such as the occurrence of hyperdeformation, will be verified.

#### Box 4

##### Nuclear rotation

The response of atomic nuclei to rotation at increasing angular-momentum values, is a fundamental and fascinating phenomenon. A new frontier of discrete-line  $\gamma$ -ray spectroscopy has been opened with the possibility of identifying rotational bands at ultra-high spins, in spite of their very weak population. The figure illustrates the spectacular evolution of nuclear structure with increasing angular momentum. This evolution is matched with the dramatic changes in nuclear shape that occur, i.e. from prolate collective at low spin, to oblate non-collective at the “band terminating” spins near  $50\hbar$ , and now to strongly deformed triaxial shapes up to  $65\hbar$  (adapted from PRL 98 (2007) 012501)

##### High temperature regime

At finite temperature  $T$  the nucleus behaves as a charged liquid drop which under the stress of rotation manifests different shapes. This is illustrated in the temperature-angular momentum diagram. At low  $T$  one expects a tri-critical point, around which oblate or prolate, rotating along the symmetry axis (non-collectively), as well as oblate shapes, rotating perpendicularly to the symmetry axis (collectively), coexist. At higher  $T$  several scenarios are predicted. The Jacobi shape transition leads from an oblate nuclear shape, rotating along the symmetry axis, through a sequence of triaxial shapes to the elongated shape, rotating perpendicularly to the symmetry axis. At spins in the vicinity of the fission limit the Poincare transition may occur – here the nucleus undergoes a shape change from elongated prolate to elongated octupole.

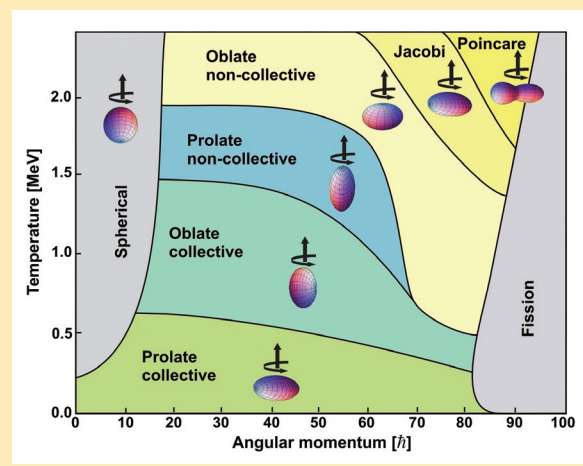
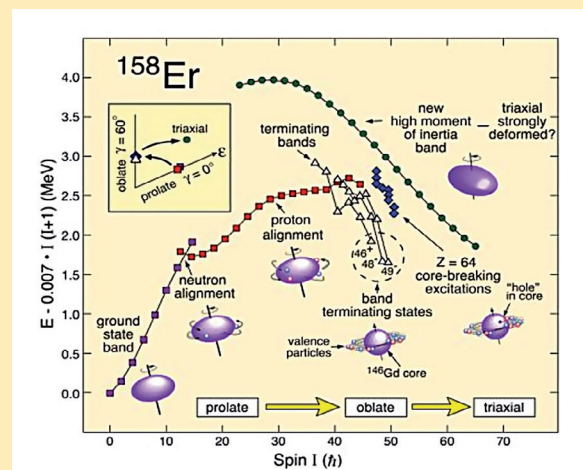

The experimental evidence for the exotic shape changes at higher  $T$ , is so far scarce. More favourable conditions are expected to be met in exotic, moderately neutron-rich nuclei. The main tool for studying these phenomena is the GDR as its strength function is sensitive to the deformation of the system.

### Shape coexistence, phase transitions and dynamical symmetries

The concept of energetic gaps occurring in the nuclear shell structure can also be extended to non-spherical equilibrium shapes. For particular neutron or proton numbers several shell gaps occur, which can lead to different shapes in the same nucleus. In some cases (e.g. in the neutron-deficient  $Z \sim 82$  nuclei) spherical and deformed shapes even compete for the nuclear ground state. In recent years, much progress has been made in the understanding of such shape coexistence by measuring ground-state properties and by probing low-lying nuclear excitations of proton-rich and neutron-rich nuclei in tagging- and Coulomb excitation experiments.

The future programme using the new and more intense heavy RIBs will shed light on the phenomena related to nuclear shapes and dynamical symmetries. The occurrence of new exotic shapes such as proton-neutron triaxiality or tetrahedral deformation and new dynamical symmetries associated with the critical points characterizing the quantum phase transitions will be elucidated in particular by measuring their electromagnetic transition properties.

The two-fluid character of the nuclear quantum system is manifested in near-spherical nuclei as low-lying quadrupole collective isovector valence-shell excitations and in deformed nuclei as scissors-mode like excitations. Systematic information extended to unstable nuclei is needed to understand the evolution of these mixed-symmetry states and the underlying microscopic mechanisms.

### Instrumentation

All these studies will benefit from advanced instrumentation, as provided by high-sensitivity gamma-ray spectrometers (AGATA), arrays for high-energy gamma-ray detection (PARIS, CALIFA), advanced devices for charged particle detection (GASPARD, HYDE, FAZIA) and high-energy neutrons (NeuLAND at R<sup>3</sup>B) as well as new spectrometers for isotopic identification of the nuclei of interest. The implementation of storage-ring methods at FAIR will enable measurements of hadronic scattering at low momentum transfer as well as electron scattering off exotic nuclei.

## 4.3.6 Reaction Dynamics

Nuclear reactions are tools with which the nuclear phase space of temperature, angular momentum and isospin can be investigated. Identification of key variables controlling the dynamics of complex colliding nuclei is still a challenge and is also called for in nuclear structure studies and astrophysics. Tremendous progress has been made in explaining reaction observables for rather simple few-body collisions at low energies, starting from EFT. A systematic comparison between results of different scattering approaches, with the same structure and dynamical inputs, with accurate data will provide valuable insights. Reactions to be investigated range from a gentle rearrangement of individual nucleons to a massive rearrangement of nucleons in deep inelastic or fission processes up to the multi-fragmentation regime.

### Fusion reactions

Nuclear fusion provides information on basic aspects of a quantum many-body system of fermions under various external forces, including quantum tunnelling with its implication on the modelling of stellar environments. It is also an essential tool to extend the periodic table of the elements. The dynamics of collisions are extremely sensitive to the plasticity of the intrinsic and evolving structure and to the interplay of many open and virtual channels, whose amplitudes can be tuned by varying the beam energy and projectile-target combinations.

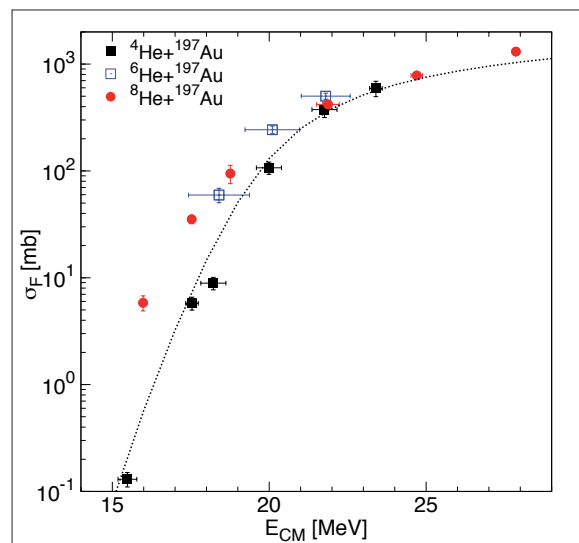

**Figure 7.** Measured fusion cross section as a function of the center-of-mass energy for the  $^{4,6,8}\text{He} + ^{197}\text{Au}$  systems. The dotted line shows the one-dimensional barrier penetration calculation for the  $^4\text{He} + ^{197}\text{Au}$  system.

## 4.3 Nuclear Structure and Dynamics

---

The influence of nucleon transfer on the fusion process continues to be a matter of debate, especially for reactions involving neutron-rich exotic beams. Fusion cross-sections for stable nuclei well below the Coulomb barrier for several medium-heavy systems are found to be much smaller than standard predictions. This “fusion hindrance”, particularly for deep sub-barrier fusion can be used to address aspects of nuclear compressibility and viscosity and to give an insight into adiabatic or sudden change in nature of the ion-ion potential between colliding nuclei. It also has a large impact on calculated nucleosynthesis rates.

Indeed, the future experimental advances with RIBs are expected to be remarkable as indicated by the experiments with  $^4\text{He}$  and  $^8\text{He}$  beams, where comparable sensitivity was achieved even though the  $^8\text{He}$  beam was six orders of magnitude less intense.

The arsenal of both stable and unstable beams combined with advances in detection techniques will also play an essential role for these advances.

### Direct and deep-inelastic reactions

The recent implementation of large acceptance spectrometers in conjunction with efficient gamma-ray detector arrays has enabled studies of the mechanism of producing nuclei by transferring nucleons with and without an exchange of a large amount of energy in heavy-ion collisions. The relative role of single-particle and pair-transfer modes can be probed in such reactions. The population of excited states in the final nuclei provides information on the contribution of surface vibrations (bosons), single particles (fermions) and their coupling. This, in conjunction with the theoretical progress in treating quasi-elastic and deep-inelastic processes on the same footing, has given a new impetus to the field.

Measurements of transfer reactions at energies well below the barrier will enable probing of particle-particle correlations with possible signatures of the nuclear Josephson effect. Reactions involving next generation radioactive beams are of particular interest, because for nuclei far from stability pair correlations should play an important role and more microscopic form-factors are required.

Deep-inelastic transfer reactions can also be used as a tool to produce neutron-rich nuclei at high angular momentum. In this way, evidence for rigid triaxiality at low spin in  $^{48}\text{Ar}$  was found.

The advent of high-intensity RIBs will open path ways towards the discovery of new phenomena at high spin in neutron-proton asymmetric nuclei.

### Fission process

Despite that the fission process has been known for nearly 70 years, the dynamics of nuclear fission remains one of the most interesting processes of the collective flow of nuclear matter. It involves an unsolved nuclear many-body problem, where the nuclear viscosity affects the large amplitude of collective motion leading to scission. In addition, fission provides the means to extend studies of nuclear structure under non-equilibrium dynamical conditions.

Recent data have revealed unexpected results:

- (i) Contrary to expectations, the position of the fission channels was found to be almost constant in  $Z$ .
- (ii) Observed fine structures in the properties of fission fragments are still unexplained. They provide an opportunity to investigate the influence of super-fluidity and the onset of dissipation, beyond the traditional models of pairing.

In addition, experimental inputs for the open problem of the damping of collective nuclear excitations into more complicated excitations rely not only on spectroscopy in the continuum but also on the systematics of fission probabilities of spherical and deformed nuclei as a function of excitation energy.

Promising perspectives are also foreseen for the detailed study of the fission fragments, so far restricted to the light fragments, from thermal-neutron induced fission. This is now possible for all  $A$  and  $Z$  using inverse-kinematics reactions and high-resolution magnetic spectrometers. The future project ELISE at the FAIR storage rings, that aims at investigating the fission of heavy-secondary beams induced by virtual photons will be a powerful tool in this direction.

### Quasi-free scattering

One-nucleon knock-out reactions using radioactive beams at energies  $> 50$  MeV/u constitute a quantitative spectroscopic tool for valence nucleons. Recently they have been used to study the removal of deeply bound nucleons in neutron-proton asymmetric nuclei. The striking observation of a strong quenching of the single-particle strength as a function of asymmetry of the neutron and proton separation energies presents a challenge to any theoretical understanding. An isospin dependent effect of the short-range correlations is predicted to be much smaller than the observed one. In stable nuclei, the reduction of single-particle spectroscopic factors has been established mainly from electron-induced and proton-induced quasi-free knockout reactions.

Recent experiments at GSI have demonstrated the feasibility of proton-induced knockout reactions



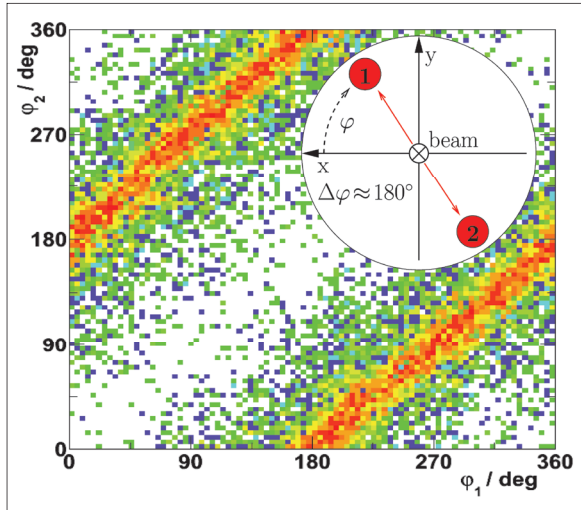

**Figure 8.** Angular correlation of protons measured in (p,2p) reactions in inverse kinematics at GSI with the proton-rich halo nucleus  $^{17}\text{Ne}$ . The strong kinematical correlation characteristic for the quasi-free nucleon-knockout reaction is clearly visible.

((p,2p),(p,pn)) in inverse kinematics at high energies (Figure 8) which are less surface dominated. In addition, this technique enables the reaction kinematics to be over-determined by measuring in addition to the two nucleons the excitation energy and momentum of the heavy residue, thus selecting the one-step direct reactions by controlling and understanding the final-state interaction. Therefore, the planned systematic study of single-particle occupancies in N/Z asymmetric nuclei is expected to shed light on short- and long-range nucleon-nucleon correlations in nuclei. Further aspects that will be investigated are the population of unbound nuclear systems beyond the neutron dripline as well as cluster structures in exotic nuclei which will be studied through measurements of alpha knockout cross-sections. An attractive extension of this programme are future measurements with polarized proton targets and high-energy radioactive beams. This programme will be fully exploited at the FAIR-R<sup>3</sup>B facility where dedicated neutron and proton detection systems are foreseen for quasi-free-scattering experiments.

New discoveries in the field of nuclear reaction dynamics at low and intermediate energies will also be delivered from studies to be carried out with the next-generation ISOL facilities and finally with the EURISOL facility.

## 4.3.7 Ground-State Properties

### Charge and matter radii, nuclear moments and spins

Charge radii for an isotopic chain provide information on the distribution of protons inside the nucleus and how this distribution is modified by adding or removing neutrons. Therefore, this is a very sensitive probe to study the proton-neutron interaction as well as the evolution of collective behaviour along an isotopic chain. Comparison of charge and matter radii provides a direct tool for studying the onset of halos and skins.

Nuclear magnetic and quadrupole moments, together with the nuclear spin of a state, largely determine its nuclear structure. These observables are sensitive to both single-particle and collective behaviour in atomic nuclei and therefore constitute very stringent probes for testing nuclear models at the extremes of spin and isospin.

### The future with laser spectroscopy methods at ISOL facilities

Laser spectroscopy methods allow measurement of the nuclear charge radius, spin, magnetic dipole moment and the electric quadrupole moment if a sufficiently high resolution can be achieved. Several developments to enhance the sensitivity of the present laser techniques and to extend their applicability to a wider range of elements are ongoing. The collinear resonance ionization spectroscopy method, presently under development at ISOLDE, will allow measurements at high resolution and sensitivity (down to 10/s) extending present studies to more exotic regions. Very exotic species will be in reach with the expected increase in intensity at HIE-ISOLDE or DESIR at SPIRAL2. In the latter facility, in combination with beams from S3, very exotic refractory elements will be available for the first time. To apply collinear laser spectroscopy to a wide range of elements, the ongoing developments at JYFL for laser pumping in an RFQ cooler/buncher are very promising.

A complementary tool is the in-source laser spectroscopy method, which is highly sensitive (< 1/s) and ideal for intermediate and heavy element studies, as shown at ISOLDE. Recently, this method was also applied on ions stopped in a gas-cell at LISOL (CRC, Louvain la Neuve). This is an extremely promising tool for laser spectroscopy studies at the focal point of a wide range spectrometer such as S3, allowing studies along the N=Z line, on refractory elements and very heavy elements.

High-precision laser spectroscopy studies for atomic and nuclear physics research or studies using laser-polarized beams for solid-state and life sciences all

## 4.3 Nuclear Structure and Dynamics

require long and stable beam conditions. A new facility is currently under investigation for this purpose (ISOL@MYRRHA).

### The future with spin-oriented radioactive beams at in-flight facilities

Complementary to the aforementioned laser studies are the measurements of moments based on the use of spin-oriented radioactive beams, produced in different low (5-10 MeV/u), intermediate (10-100 MeV/u) and high (0.1-1 GeV/u) energy reactions with intense primary stable-ion beams. To maintain the reaction-induced orientation during the in-flight selection process, fully stripped secondary beams are needed. In the future, at the super-FRS of FAIR intense high-energy beams from U-fission and fragmentation will allow studies on isomeric beams to be extended to the neutron-rich  $A > 100$  region. For studies of ground-state moments, spin-polarized fragment beams require an asymmetric secondary beam selection, currently available at some of the in-flight facilities. In the future, post-accelerated radioactive beams up to 150 MeV/u from EURISOL can be used for producing even more exotic polarized fragment beams for moments studies of elements not accessible by laser methods.

### The future with relativistic radioactive beams

Measurements of nuclear reaction cross sections at relativistic energies (500-1000 MeV/u) allow for the matter radii of unstable nuclei to be determined. Since matter radii are directly related to the nuclear size, the measurement of total interaction cross-sections is capable of unravelling unusual nuclear structures, such as halos. Moreover, from knowledge of both matter and charge radii one can deduce the neutron skin thicknesses, e.g. from optical isotope shift measurements. For nuclei of  $A > 30$ , the relation to EOS is discussed and important constraints to the parameters of asymmetric nuclear matter can be obtained.

Due to the different cross-section and energy dependence of p-p and p-n interactions in nuclear reactions, diffuseness and radius parameters for matter and charge distributions can be determined from a Glauber-model based analysis of interaction cross-sections, obtained from different targets at different energies. Using relativistic radioactive beams at SuperFRS of FAIR, skin thicknesses can be deduced even for very weak beams with rates down to  $\sim 0,1$  ions per second, where optical methods are not applicable. With higher intensities, more detailed information on the radial charge and matter distributions can be obtained by elastic and inelastic

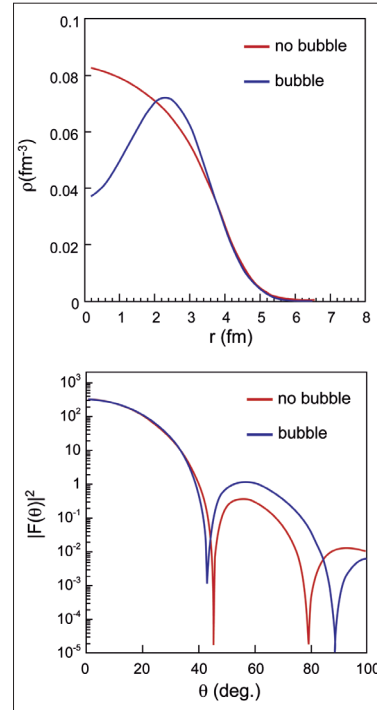

**Figure 9.** Top: radial proton density distributions of  $^{46}\text{Ar}$  calculated with different forces in the HF-approach. Bottom: angular differential form factors, which will be obtained from 300 MeV electron scattering off the density distributions from the top.

scattering off light hadronic probes in inverse kinematics in storage rings and by scattering off leptonic probes in an electron-nucleus collider, as is planned in the ELISE experiment at FAIR. As an example, Figure 9 shows the proton density distributions in  $^{46}\text{Ar}$  and the corresponding form factors, according to different calculations. The ELISE experiment will be able to distinguish whether the predicted proton bubbles do really exist.

### Nuclear masses

Nuclear masses directly probe the total binding energy of nuclei and have always played a key role in experimental and theoretical nuclear physics. Accurately known binding energies serve to derive effective nuclear forces and to fit the parameters of the interaction, in order to reproduce not only nuclear masses, but also empirical saturation properties of nuclear matter and neutron stars.

Together with beta-decay half-lives and reaction rates, masses are important quantities for nuclear astrophysics and the quantitative understanding of solar abundances, energy- and neutron sources in quiescent and explosive burning processes and also for constraining duration, pathway and physical conditions of stellar nucleosynthesis.

Derived quantities, such as proton- and neutron-separation energies and pairing-gap energies, often give

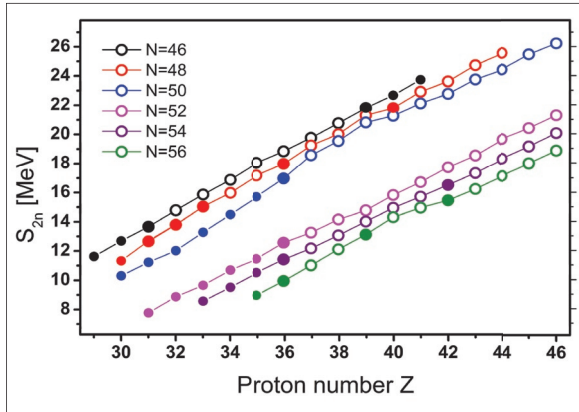

**Figure 10.** Two-neutron separation energies for even-N isotones. Filled symbols are extracted from recent direct mass measurements and the open symbols are based on the Atomic Mass Evaluation. The energy difference between N=50 and N=52 isotones, corresponding to a two-neutron gap across N=50, reveals a lowering trend till germanium followed by an indication of persisting N=50 shell gap.

the first hints of structural changes, such as onsets of deformation, nucleon pairing, proton-neutron interaction strengths and symmetry effects.

### Instruments and future directions for direct mass measurements

The knowledge of nuclear masses has developed rapidly in recent years. Various methods have been implemented including ion traps, storage rings and time-of-flight spectrometers. They are adapted to the various production and separation methods of exotic nuclei, including super-heavy elements and reach highest sensitivity (single-ion detection), highest selectivity (isomer separation), sub-keV precision and measurement times down to  $\sim 10$  ms. Setups and programmes for direct mass measurements are important pillars of almost all existing RIB facilities in Europe, thus contribute to their efficient and full exploitation.

Of particular importance is the development hybrid systems, which combine stopping in gas cells after in-flight separation. With this universal approach, low-energy and high-purity beams from fragmentation, fission or fusion-evaporation reactions can be produced with high phase-space density, thus combining the advantages of ISOL and in-flight methods.

Tests of fundamental symmetries such as the CVC hypothesis or the unitarity of the CKM matrix requires ultimate accuracy, which is also needed for QED tests, electronic binding energy measurements and for the neutrino-mass determination from the mass difference of  $^3\text{H}$  and  $^3\text{He}$ .

For nuclear astrophysics applications it is essential to further push the isospin frontier and to reach very n-rich isotopes of r-process elements. While mass measurements at present facilities barely touch the r-process path, the intensity gain of the next-generation facilities SPIRAL2, FAIR and EURISOL will allow to entry into this terra incognita. This will also contribute towards answering the question, whether and if so, to what extent, the re-cycling of fissioning superheavy r-nuclei contributes to the abundances of medium-heavy elements.

## 4.3.8 Facilities and Instrumentation

### Accelerator facilities

The ambitious future plans of nuclear structure research discussed in the previous chapters rely on the availability of complementary RIB and stable-ion beam facilities.

The advent of the first generation of RIB facilities has already opened up a new era in probing nuclei at and beyond the limits of stability and in accessing new regions of the nuclear chart. The last decade has seen many important experimental results in nuclear structure and dynamics originating from the first generation European RIB facilities at GANIL, GSI and ISOLDE. The two complementary methods of producing RIB, in-flight separation and ISOL approach, combined with different post-processing of the radioactive nuclei, will form the pillars of the RIB facilities network in Europe.

The major next generation in-flight RIB facility in Europe is the FAIR-NuSTAR facility, which is based on the production of fragments from GeV/u beams and their separation in the Super-FRS. First RIBs from the Super-FRS are expected in 2016. FAIR and the ISOL facility SPIRAL2 at GANIL are the nuclear physics projects on the current ESFRI Roadmap. SPIRAL2 together with the HIE-ISOLDE project, recently endorsed by the CERN Research Board, and the SPES facility at LNL are due to come on-line in 2013-2015. They are complementary intermediate stage projects to bridge the technological gap between present day facilities and the ultimate ISOL facility EURISOL. During the last decade an extensive R&D programme and a design study have been carried out for EURISOL. A preparatory phase could start within the next 5 years, and construction could be achieved by 2025.

The scientific programme of NuSTAR and EURISOL will cover all major topics relevant for modern nuclear structure and dynamics research. For specific and very

## 4.3 Nuclear Structure and Dynamics

---

time consuming nuclear physics experiments RIBs may also be available in the future from the ISOL@MYRRHA facility, proposed to be constructed in Belgium, and making use of a fraction of the very intense proton beam from the ADS prototype facility MYRRHA.

The next generation RIB facilities will be able to deliver beams with several orders of magnitude higher intensity and higher purity, for a wider variety of radioactive nuclides. These extremely demanding goals involve a large number of technological challenges. Important R&D work was carried out in the past not only at the current RIB facilities, but also at the ALTO (Orsay), EXCYT (LNS), IGISOL (JYFL) and LISOL (Louvain la Neuve) facilities. Thanks to this very intense R&D effort, solutions for many of these challenges have been found.

Outside Europe several RIB facilities and future projects exist. The most important running facilities are the RIB Science Laboratory at RIKEN in Japan and the ISAC2 facility at TRIUMF in Canada. In the USA a large community is working towards the construction of the next-generation FRIB facility which could become available by the end of this decade. Although healthy competition exists between these and the European projects, the long tradition for international collaboration within nuclear physics gives synergy even across the continents.

Stable-ion beam facilities in Europe, capable of accelerating a large variety of ions at high intensity are vital for the community. They will continue to address major physics problems at the frontiers of nuclear structure and reaction studies and are particularly needed to produce neutron deficient nuclei up to and beyond the proton-drip line, as well as superheavy elements via fusion evaporation reactions.

Two categories of stable-ion beam facilities can be identified:

- (i) Accelerator systems capable of delivering a large variety of ion beams up to 100 pnA for in-beam studies, where the beam intensity is limited by the detector counting rates. Such accelerators are in use at JYFL, LNL and LNS.
- (ii) High-intensity beams up to 100 pμA are needed in off-beam studies of extremely weakly produced nuclei such as super-heavy elements. In such experiments the maximum beam intensity is dictated by the capability of the target to sustain a large power deposition. Installation of the high-intensity LINAG within the SPIRAL2 project and a dedicated cw-linac as proposed at GSI will be milestones in this direction.

Smaller accelerator facilities are needed for specific experiments, instrument development and testing, to

reach large user communities and provide education of next-generation researchers from university groups. Here the accelerators in the emerging countries play an important role. Their scientific capabilities will be strongly enhanced by the EWIRA joint research activity of the EU-IA-ENSAR project.

### Instrumentation

Highly efficient and versatile instrumentation is a key feature in making the best possible use of the precious rare isotopes produced by the facilities. All large instrumentation projects in today's nuclear structure and reaction research are governed by co-operation in R&D work between groups, which often represent different subfields of the community. In the future this approach is even more vital in order to construct the most versatile and powerful detection systems for probing exotic nuclei. They need to combine identification (in  $A$  and  $Z$ ) of the outgoing reaction products together with detection of all emitted particles (gamma-rays, electrons, charged particles, neutrons etc.). The R&D projects are driven by physics ideas, but the introduction of new innovative experimental techniques and/or new materials often reveal unexpected phenomena.

### Identification and decay spectroscopy

Having produced a new isotope or element, the first task is to uniquely identify it. Therefore powerful detection systems have to be developed for the focal plane of the separators or spectrometers which often also measure the decay radiation or can be coupled to other detection systems. Successful developments for stable-ion beam facilities such as GREAT (JYFL) or MUSETT (GANIL) paved the road for new systems with higher granularity and larger dynamic ranges such as the AIDA implantation system currently being developed for the Super-FRS.

### High-sensitivity gamma-ray detection

High-granularity arrays consisting of Compton-suppressed Ge-detectors and various ancillary detection systems have recently resulted in an unprecedented sensitivity for spectroscopy and reaction studies. Pioneering work at RIB facilities has been carried out by employing the EXOGAM, MINIBALL and RISING (EUROBALL clusters) arrays at GANIL, ISOLDE and GSI, respectively. Ge detector arrays comprised of former EUROBALL detectors have been combined with the high-transmission magnetic separators, PRISMA at LNL and RITU at JYFL for measurements with stable-ion beams. The results at LNL show that multi-nucleon transfer reactions will serve as a step forward in structure studies of



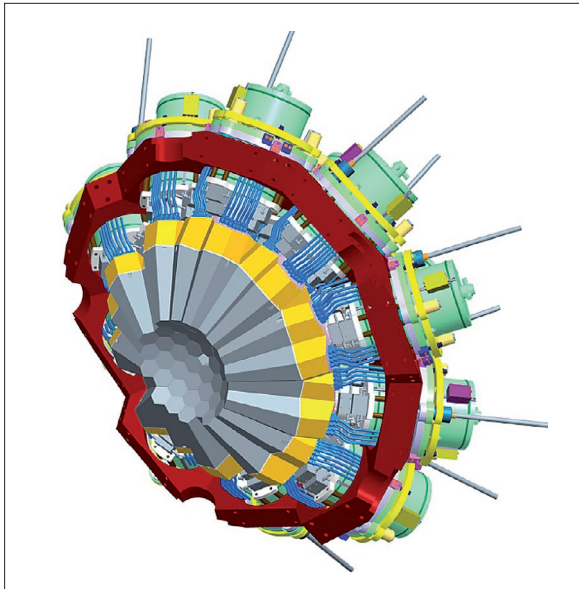

**Figure 11.**  $1\pi$  section of the AGATA array comprising 45 encapsulated 36-fold segmented Ge-crystals in triple clusters.

neutron-rich nuclei. At JYFL it has been shown that the recoil-decay-tagging method enables in-beam spectroscopy of transfermium and proton drip-line nuclei.

The Advanced GAMMA Tracking Array (AGATA) will represent a breakthrough in instrumentation for high-resolution gamma-ray spectroscopy (Figure 11). The first  $4\pi$  gamma-ray spectrometer, solely built from Ge detectors is based on the novel technique of gamma-ray tracking and will be a key instrument in RIB experiments at FAIR-NuSTAR and SPIRAL2 and will be capable of handling the highest RIB intensities expected from EURISOL. In the near future smaller AGATA sub-arrays offering high energy and position resolution will be available and combined with high-transmission magnetic separators and spectrometers as well as other ancillary detection systems.

### High-energy gamma-ray and charged particle calorimetry

Detection of high-energy gamma-rays and charged particles is needed in studies of shape evolution and shape-phase transitions with RIBs and high-intensity stable-ion beams. The PARIS array, designed especially for such studies, will be composed of advanced fast scintillation detectors. It can be combined with AGATA and charged-particle arrays and also with the next generation recoil separator S3. A charged particle detector array for such studies will be FAZIA, which can also be combined with gamma-ray detector arrays.

A detector array for high-energy photons from reactions induced by relativistic RIBs is the CALIFA calorimeter, which is designed to be a part of the R<sup>3</sup>B system at FAIR. The high granularity of CALIFA will be provided by thousands of CsI(Tl) scintillation detectors arranged in a special geometry.

### Versatile instrumentation for nuclear reactions

For comprehensive studies of light nuclei from the proton-rich to neutron-halo regime, a large variety of methods and instruments is already being used. Reactions involving short-lived RIB nuclei have to be performed in inverse kinematics, which imposes a challenge, but also enable novel techniques for kinematically complete measurements to be employed.

In order to reach the most exotic species novel radioactive and cryogenic targets need to be developed as well as active target systems like ACTAR, where the gas target is integrated with the particle detectors for studies of trajectories of very rare low-momentum transfer events. GASPARD and HYDE are particle-detector systems designed for scattering experiments on light-ions (p,d,...). Their compactness will allow the combination with spectrometers and detectors for low- and high-energy charged particles, neutrons and gamma-rays. These systems will be employed for studies of a wide range of nuclear structure physics including exotic light systems, evolution of shell gaps, collective responses of exotic nuclei as well as phenomena characteristic to N=Z and proton-rich nuclei.

Recent studies of heavy ion transfer reactions have largely benefited from the construction of the new generation large solid angle spectrometers based on trajectory reconstruction, such as PRISMA and VAMOS.

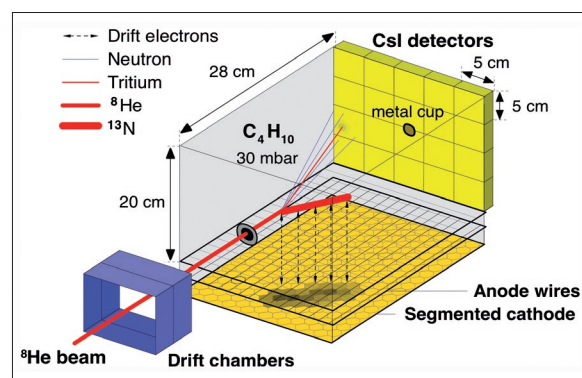

**Figure 12.** The system with the highest N/Z ever produced is  ${}^7\text{H}$ . It was identified as a resonance in the  ${}^8\text{He}({}^{12}\text{C}, {}^{13}\text{N})$  reaction at 15 MeV/nucleon at GANIL. The active target MAYA was employed to measure kinematical correlations of the reaction residues.

## 4.3 Nuclear Structure and Dynamics

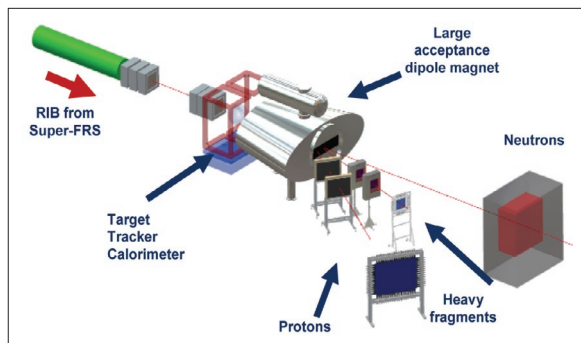

**Figure 13.** Schematic view of the  $R^3B$  setup comprising the calorimeter CALIFA, a target-recoil tracking system, a large-acceptance super-conducting dipole, the neutron detector NeuLAND, as well as tracking systems for charged particles and heavy ions.

When combined with efficient gamma-ray arrays, these spectrometers will play an important role in studies of elastic and inelastic scattering and various transfer processes, especially with RIBs.

The study of extremely neutron-rich nuclei makes high-granularity and high-efficiency neutron detector arrays mandatory. Examples are the NEDA and neutron-TOF arrays for SPIRAL2, optimised for the detection of reaction and decay neutrons, respectively, and the equivalent DESPEC instrumentation for NuSTAR.

A prominent example for the next generation experiments for kinematically complete measurements of reactions with relativistic RIB is the  $R^3B$  setup at the Super-FRS at FAIR. Important contributions for nuclear structure research are expected from studies of unbound systems, knock-out and quasi-free scattering and multipole responses of nuclei as a function of  $N/Z$ , which all belong to the  $R^3B$  physics programme.

### Experiments at storage rings

A worldwide unique feature of NuSTAR at FAIR is the storage-ring complex, which provides a special nuclear-physics programme with relativistic highly-charged radioactive nuclei. Precision experiments with cooled and uncooled beams allow properties of ground and isomeric states (masses, lifetimes, decay properties) to be investigated. Pure isomeric beams can be produced for half-life studies, which are impossible with conventional methods. Atomic spectra and nuclear properties can be studied in the laboratory under conditions, which prevail in stellar plasmas: highly-charged ions exhibit new decay modes and altered decay properties, which affect the modelling of stellar nucleosynthesis. Reaction studies with internal targets and hadronic and leptonic probes will be the goal of the EXL and ELISE experiments.

### Traps and lasers

Ion traps have recently played a key role in extending accurate mass measurements towards the production limits of exotic nuclei. The resulting systematics are crucial for astrophysics and fundamental interactions research, but will also be combined with other spectroscopic data for studies in changes of nuclear structure. Ion traps will also be used to deliver pure species of short living exotic nuclei for spectroscopic studies as recently shown with JYFLTRAP at IGISOL. A unique combination of ion-traps called MATS is designed for mass measurements and decay studies at FAIR-NuSTAR.

Developments to extend laser spectroscopy methods to accurate measurements of the charge radius, spin, magnetic dipole moment and also the electric quadrupole moment of exotic isotopes are going on within the LaSpec project at NUSTAR and at the DESIR facility, a comprehensive facility for decay spectroscopy, laser spectroscopy, mass spectrometry and ion trapping techniques, designed for low-energy beams generated by SPIRAL and SPIRAL2.

During the last decade, laser resonance ionization has developed into a mature technique, playing a key role in the production of pure RIBs at ISOL facilities. The technique has advanced and developed to a point where it is the most favoured production mechanism of RIBs at ISOLDE, where it is used also for producing isomeric beams. Isomeric beams open up a new degree of freedom in e.g. reaction or decay studies, and will be one of the key developments in the future ISOL facilities.

### Technological challenges

A common feature of the above mentioned detection systems is the very large number of electronics channels, which can in some cases exceed  $10^4$ . The nuclear structure community has therefore started to develop highly integrated front-end electronics based on application specific integrated circuits (ASIC). Contrary to high-energy physics these need to address a number of conflicting requirements, e.g. large dynamic ranges, low intrinsic noise for high resolution spectroscopy etc.

Future in-beam studies and also focal-plane studies of medium-heavy and light nuclei with intense RIB and especially stable-ion beams are often limited by the counting rates of the associated detectors. Therefore, in addition to various types of highly segmented detectors, novel digital electronics and triggerless data acquisition systems need to be developed further.

In experiments synthesising and studying the rarest nuclei, such as very heavy elements, limits are set by the large power deposition in the target and by the resolving

---

and rejection power of separators. Innovative high-power target and separator developments are going on. Such a separator will be the state-of-the-art multipurpose separator S3 to be employed at the high-power LINAG of SPIRAL2 and TASCA for the cw-linac designed for SHE studies at GSI.

### 4.3.9 Recommendations

#### Radioactive Ion Beam (RIB) facilities

**The continued strongest support for the full completion and utilization of the international RIB facilities, NuSTAR@FAIR and SPIRAL2, in coherence with the ESFRI recommendations (2005, updated in 2008) which had prioritized their implementation.**

**The strongest support for the full completion and utilization of HIE-ISOLDE, recently approved (2009) by CERN, and SPES, funded by INFN. These advanced ISOL facilities, together with SPIRAL2, will bridge the technological gap between present day facilities and EURISOL, the next generation ISOL facility for Europe.**

**The realisation of EURISOL. This long-term goal is the highest priority of our community for a future major facility that offers unique physics opportunities. Accession to the ESFRI list, based on the extensive Design Study for EURISOL carried out during the last decade, should be promoted in the near future.**

The construction of these facilities and the large variety of state-of-the-art instrumentation necessary for their optimal exploitation, in a collaborative spirit of exchange of technological expertise, is vital in order to ensure a world-leading physics programme in Europe.

During the preparatory work and construction of the new facilities, the existing facilities should be fully exploited. A co-ordinated approach is needed to provide the necessary human and financial resources.

The timely and complete realisation of the NuSTAR facilities at FAIR, as outlined in the Baseline Technical Report, is of utmost importance for the envisaged physics programme.

SPIRAL2, HIE-ISOLDE and SPES form a complementary network of advanced radioactive beam facilities that are paving the way for the ultimate European ISOL facility EURISOL. In the next few years it will be necessary to continue to fund a specific R&D programme for a few remaining technical challenges for EURISOL. A

Project Office will ensure a continuous and coherent effort and promote accession to the ESFRI list. Four site options that build on existing facilities, CERN, GANIL, LNL-Legnaro and Rutherford laboratory have been identified as being suitable hosts for EURISOL. By upgrading these facilities, for example by replacing the SPIRAL2 post accelerator at GANIL by a more powerful LINAC or promoting a high intensity solution for the replacement of the CERN injector chain, a substantial advance can be made towards the realization of EURISOL.

#### Stable-ion beam facilities

##### Very strong support for existing and future stable-ion beam facilities.

Accelerators designed to deliver very high-intensity stable-ion beams are the high-power LINAG of the SPIRAL2 facility and the new cw-linac proposed at GSI. The completion of these facilities together with high-performance separators is highly important, especially for off-beam studies of extremely rare nuclei, such as superheavy elements.

The laboratories where access within the EU-IA-TNA-ENSAR project is offered for the use of stable-ion beams and where the variety and intensity of such beams will be further improved are ALTO-Orsay, GANIL-Caen, GSI-Darmstadt, JYFL-Jyväskylä, KVI-Groningen, LNL-Legnaro and LNS-Catania.

Smaller scale facilities with stable-ion beams in Central and South-Eastern Europe (Athens, Bucharest, Debrecen, Krakow, Prague, Sofia, Warsaw and Zagreb) have started a process of integration through the EU-IA-JRA-ENSAR activity EWIRA. These national and other university based facilities are needed for specific experimental programmes, development and testing of new instruments and to provide education of next-generation researchers from university groups.

The long-term goal for a new dedicated high-intensity stable ion beam facility in Europe is recommended as an important future project. The ECOS network is considered to play a key role in preparing this project and also in networking the existing stable ions beams facilities in Europe.

#### AGATA

##### Very strong support for the swift realisation of the AGATA spectrometer

The first implementation of the Advanced GAMMA Tracking Array, the AGATA demonstrator realising 1/12 of the full spectrometer, has been in operation at LNL

## 4.3 Nuclear Structure and Dynamics

---

since spring 2010, thus completing more than 10 years of R&D on gamma-ray tracking. The joint European AGATA collaboration is currently in the process of securing funding for the construction of 1/3 of AGATA by 2013. The completion of this stage and the realisation of the full AGATA spectrometer is recognized to be of utmost importance for the successful exploitation of present and future radioactive and stable-ion beam facilities.

### **Theory initiative**

#### **New project for advanced studies in theoretical nuclear structure and reaction physics of exotic nuclei bringing together theorists, computer scientists and experimentalists to support and stimulate experimental research performed at the European facilities**

To meet the challenges brought by the new area of nuclei accessed by future experimental facilities, all theoretical models will have to progress in several directions. Many questions can only be addressed by a strong coordination of the often small theory groups working in Europe and having a strong expertise in specific models. To bring the necessary support to the experimental facilities, a new project unifying all the individual efforts should be launched in Europe in the near future. This project for advanced studies in theoretical nuclear structure and reaction physics of exotic nuclei must bring together theorists, computer scientists and experimentalists to support and stimulate experimental research performed at the European facilities to define new research directions, and to encourage and shepherd international scientific collaborations between low-energy nuclear theory groups in Europe. The principal thrust should come from the existing and future large European infrastructure facilities which should integrate theory to a much higher degree as compared to the present situation.

ECT\* in Trento must be supported in its leading role as a training centre for young researchers, and an international venue for scientific meetings that involve both theorists and experimentalists from all domains of nuclear physics, and related fields.



## 4. Scientific Themes

---

### 4.4 Nuclear Astrophysics

**Convener:** Brian Fulton (York)

Nicolas Chamel (Bruxelles),  
Zsolt Fülöp (Debrecen),  
Fairouz Hammache (Orsay),  
Michael Heil (Darmstadt),  
Jordi José (Barcelona),  
Gabriel Martínez Pinedo (Darmstadt),  
Francois de Oliveira (Caen),  
Paolo Prati (Genova),  
Thomas Rauscher (Basel),  
Stefano Romano (Catania),  
Kerstin Sonnabend (Darmstadt),  
Christof Vockenhuber (Zürich),  
Phil Woods (Edinburgh)

**NuPECC Steering Committee Member:**

Paul-Henri Heenen

**NuPECC Liaison:**

Sotirios Harissopulos

## 4.4 Nuclear Astrophysics

### 4.4.1 Introduction

#### The scope of nuclear astrophysics

From the first few seconds of the Big Bang which created the seed material for our universe, through to the present energy generation in our Sun which keeps us alive, nuclear physics has shaped the evolution of the universe and our place in it. Along the way, nuclear reactions have controlled the evolution and death of stars forming the most compact objects in the Universe, determined the chemical evolution of galaxies and produced the elements from which we ourselves are built. Our understanding of this complex evolution has developed as a result of nuclear physicists working closely with cosmologists, astrophysicists and astronomers in a hugely productive collaborative effort to understand the development of the universe and our place in it. Some of the key questions for the field are:

- *How and where are the elements made?*
- *Can we understand, and recreate on Earth, the critical reactions that drive the energy generation and the associated synthesis of new elements in Stars*
- *How does the fate of a star depend on the nuclear reactions that control its evolution?*
- *What are the properties of dense matter in a compact star such as a neutron star or a hypothetical quark star?*

Over the last decade our understanding has expanded enormously as the result of intensive experimental and theoretical activity. New highly sensitive techniques have been developed to analyse specks of stardust which arrive at the Earth in meteorites. X-ray and  $\gamma$ -ray detectors onboard satellites have revealed detailed information on the ongoing nucleosynthesis in the universe and will soon provide direct measurements of element production in Novae, X-ray Bursters and Supernovae. Detectors in deep underground laboratories have picked up the elusive neutrinos from our sun and supernova, directly probing the nuclear reactions in the sun's core and confirming the general features of current supernova models. A rich variety of neutron stars have been discovered, revealing remarkable phenomena, which in turn have triggered a burst of theoretical studies. Theoretical models have been developed to the stage where we can begin to elaborate realistic simulations of neutron stars. More understanding will come with the advent of new powerful instruments and the development of gravitational-wave astronomy. In parallel we have developed a new generation of facilities which for the first time allow us to directly measure the key nuclear reactions involved in the dramatic outbursts in explosive astrophysical sites. These facilities also provide new experimental tools for

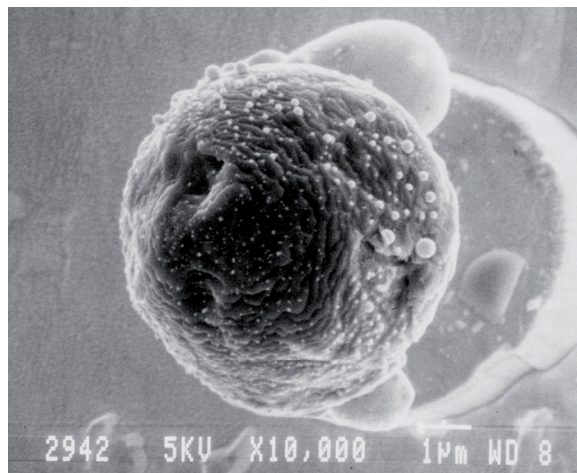

**Figure 1.** This image is of a speck of star dust which condensed in the ejecta of a distant Nova and which has been brought to Earth as an inclusion in a meteorite. Having these original materials available here on Earth enables us to use the extremely sensitive techniques like AMS to probe the detailed isotopic composition, revealing clues as to the environment in which the nucleosynthesis occurred.

probing the properties of dense nuclear matter that can be found in the interior of neutron stars.

As this understanding has developed, we have come to recognize three main classes of nucleosynthesis; the nuclear reactions which occurred in the first few minutes of the universe and led to the production of the primordial hydrogen and helium (Big Bang nucleosynthesis), the reactions which occur during the life of a star and which provide the energy which stabilises the star against gravitational collapse (Hydrostatic equilibrium nucleosynthesis) and the more complex reactions which occur in more dramatic objects like Novae, X-ray Bursters, Supernovae etc. when stars reach the end of their life cycles (Explosive nucleosynthesis). In recent years increasing attention is being directed at understanding the possible existence of novel states of matter in compact objects such as neutron stars. A detailed understanding of all these objects is required to follow Galactic Chemical Evolution throughout the history of the Universe. Later in this chapter we review the present state of knowledge, and identify the key areas where new measurements are needed to enable our understanding to advance.

#### The role of nuclear experiment and theory

Whether it is the steady release of energy in the core of a star which stabilises it against the crushing grip of gravity, or the violent, explosive energy release in Novae, X-ray Bursters and Supernovae, it is nuclear energy that

---

powers many of the objects we observe in the cosmos. These same nuclear reactions which generate the energy also transmute the atoms to create new elements. The early universe which emerged some minutes after the Big Bang comprised only hydrogen and helium. This would have remained a sterile and uninteresting place, and one certainly not conducive to the development of life, were it not for the gradual transformation of these light elements into heavier ones through nuclear reactions in stars.

The rates at which the reactions occur depend particularly on the temperature in the particular site, as the reaction cross sections depend on the energy in the collision. At the (relatively) low temperatures during hydrogen and helium burning the rates can be very low, with nuclei existing for millions of years before being changed in a reaction. For this reason only stable nuclei are important, since any unstable nuclei produced in the reactions have time to decay. For massive stars, as the temperature in the stellar core grows photodissociation reactions become more and more important. Finally, after Silicon burning processes mediated by the strong and electromagnetic interactions reach equilibrium. However, weak interaction processes never reach such an equilibrium and should be explicitly considered. Initially, electron captures and  $\beta$  decays are the most relevant processes but as the density increases neutrino interactions also became important. The neutrinos produced in the stellar core play a very important role in the explosion of massive stars, the nucleosynthesis of heavy elements and if detected on Earth may provide us with valuable information about the dynamics of the stellar core.

In explosive sites like nova, X-ray burst and supernova, the interval between individual nuclei undergoing a reaction drops dramatically and here the nuclear reactions can be dominated by unstable nuclei. This has posed a challenge to us until recently, firstly because we don't know much about the structure of these "exotic" nuclei and secondly because we did not have the ability to mimic collisions here on Earth. The recent development of radioactive beam facilities has removed this restriction and will result in rapid advances in the field with early progress already present.

Neutron capture processes followed by  $\beta$ -decay are also important and are responsible for the production of most of the elements heavier than Iron. In particular the r-process remains a major challenge both for experimentalists (to measure the rates) and for theorists and modellers (to understand in which sites in the universe this process occurs). Moreover, it is quite possible that we have not yet uncovered all the reaction processes which occur in the universe – as exemplified by the recent discovery of the up-process.

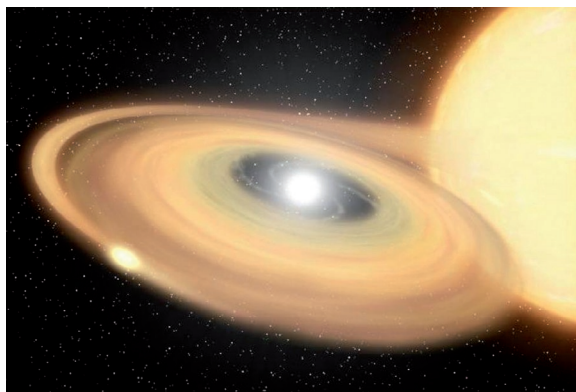

**Figure 2.** An artist's impression of a Nova, Type Ia Supernova, or X-ray Burster in a binary star system. Material streaming from an evolving star feeds down onto its companion white dwarf (Nova, SNIa) or neutron star (X-ray burster) to become compressed and ignited in a runaway thermonuclear explosion.

If we want to understand how this energy generation determines the evolution of a particular astrophysical site then we need to understand the details of the various nuclear reactions that can occur – how probable are they, how much energy do they release, what new nuclei do they produce? To do this we recreate the collisions here on Earth, using accelerators to produce fast moving nuclei of one type which we can then collide with a target containing atoms of the other type. Various detector systems can then be placed around the collision point to determine the reaction probability, the energy release and the various nuclei produced. By varying the energy of the accelerator we can select the energy of the collision appropriate to the conditions (temperature) in the astrophysical site that we are interested in.

The facilities that we need for these studies can vary enormously. Sometimes small accelerators housed in University labs will suffice, while for other studies extremely large, multi-stage facilities are required whose technological complexity requires the resource of major international laboratories. The detection systems can also vary tremendously in complexity and scale, depending on the particular reaction being studied. Other challenges arise if we are looking at very low probability reactions when sometimes the very infrequent collisions of interest may be masked by signals in the detectors from natural background radioactivity or cosmic rays. In extreme cases this may require the measurements to be carried out in deep underground laboratories where these backgrounds can be screened out. Furthermore, not all of the reactions of interest involve two colliding nuclei of the type that can be accelerated in conventional accelerators – some involve particles like neutrons and neutrinos, or high energy photons, which may require much more complex facilities. In a later section we will

## 4.4 Nuclear Astrophysics

look at the range of facilities which will be needed in future years to address the key questions in each of the areas of nucleosynthesis.

Nuclear astrophysics does not, however, simply involve the measurement of reactions. In some cases technical or physics considerations mean we cannot accelerate the nuclei we need, or the reaction rates are too low for us to measure. In addition, effects due to finite temperature and the presence of the stellar plasma cannot be reproduced in the laboratory. In some astrophysical sites the evolution is determined by enormous networks of reactions – too many for us to measure – while in other sites (e.g. neutron stars) the extreme conditions prevailing in their interior are very far from those encountered in laboratory experiments. For this reason the field also requires advanced theoretical study, developing nuclear models which can predict the key nuclear properties (nuclear levels, masses, optical potentials, decay rates, equation of state of dense matter etc.) and theories to enable us to calculate reaction probabilities. Often this work is carried out at the interface with astrophysics theorists who model the astrophysical sites. In a later section we identify where the key theoretical advances are required and what computational resources are required to support this.

### 4.4.2 State of the Art and Future Directions

#### Big Bang nucleosynthesis

The Big-Bang model is supported by three pieces of observational evidence: the expansion of the Universe, the Cosmic Microwave Background (CMB) radiation and the Primordial or Big-Bang Nucleosynthesis (BBN). The latter evidence comes from the primordial abundances of the “light elements”:  $^4\text{He}$ , D,  $^3\text{He}$  and  $^7\text{Li}$ . Historically the comparison between their BBN calculated abundances and those deduced from observations in primitive astrophysical sites were used to determine the baryonic density of the Universe  $\Omega_B$ . The latter is now more precisely deduced from the observations of the anisotropies of the CMB radiation. Hence, all the parameters of the Standard BBN ( $\Omega_B$ , the number of neutrino families and the nuclear reactions) are now known and the BBN is now used as a probe of the early Universe. Indeed, deviations from the standard BBN results may be hints of non-standard physics.

Most of the nuclear reactions responsible for the production of  $^4\text{He}$ , D,  $^3\text{He}$  and  $^7\text{Li}$  in the Standard BBN model have been measured in the laboratory, usually at

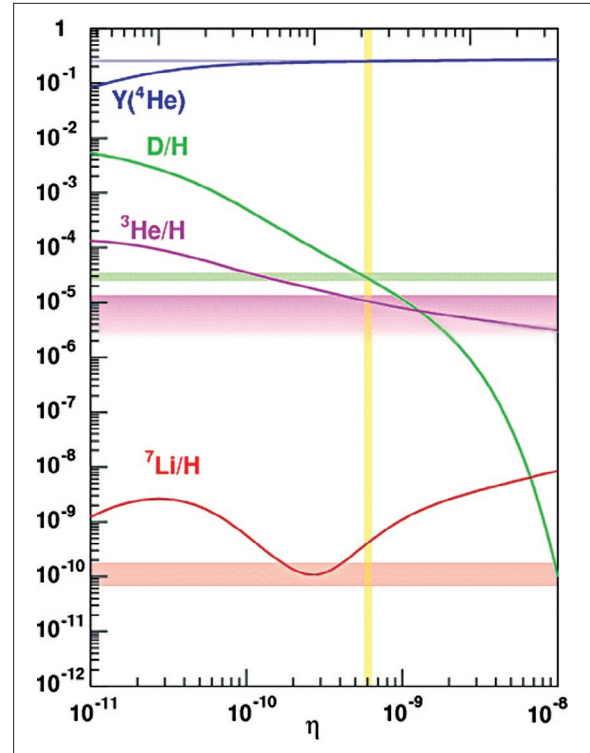

**Figure 3.** The relative abundances of the light elements as predicted by BB nucleosynthesis model are shown as a function of the baryonic matter density in the universe. The horizontal bands show the experimentally observed abundance measurements (and uncertainty). The values are, except for Li, in agreement with the value expected from measurements of the CMB radiation (yellow line).

the relevant energies. Despite the fact that the primordial abundances of these light isotopes span nine orders of magnitude, the agreement between the BBN calculations and the observations is good for helium and excellent for deuterium. However, the calculated  $^7\text{Li}$  abundance is a factor of  $\approx 5$  above the value deduced from observations of low metallicity stars in the halo of our galaxy where the Li abundance is found to be almost independent of metallicity. This discrepancy is surprising and its origin remains an open question. The small scatter of values around this “Spite plateau” is an indication that in situ stellar depletion may not have been very effective. It is thus essential to determine precisely the *absolute* cross sections important for  $^7\text{Li}$  nucleosynthesis, e.g.,  $^2\text{H}(p,\gamma)^3\text{He}$  and  $^3\text{He}(\alpha,\gamma)^7\text{Be}$  need to be measured with greater precision. That would allow for a better determination of the required  $^7\text{Li}$  depletion factor in stellar model calculations, or better limits on non-standard BBN models.



## Hydrostatic burning

Stars spend the longest part of their life in an equilibrium balance between the gravitational contraction and an outward flow of energy produced by nuclear reactions taking place in their inner shells. This condition is usually referred to as hydrostatic equilibrium. Stars start burning H and producing heavier elements, He in the first phase, then He is burned to produce C and O, C to produce Ne and subsequently the Ne, O, and Si-burning phases take place before the last and much shorter stages of stellar evolution. Nuclear reactions that generate energy and synthesize elements take place inside the stars in a relatively narrow energy window: the Gamow peak. At stellar energies the cross sections are so small that for a long time their direct measurement in laboratories at the Earth's surface was not possible as the signal to noise ratio is often too small because of the relatively high cosmic ray background – although coincidence counting techniques have been developed to reduce this.

In the last 20 years, the most important reactions involved in the H-burning phase (through the well known p-p chain and CNO cycle) have been studied by solving challenging experimental difficulties. In some crucial cases, the sole possibility was to install an accelerator deep underground (under the Gran Sasso mountain in Italy) to shield the detectors against the background of cosmic radiation. Outstanding results have been obtained on the cross-sections of  ${}^3\text{He}({}^3\text{He}, 2p){}^4\text{He}$ ,  ${}^2\text{H}(p, \gamma){}^3\text{He}$ ,  ${}^3\text{He}(\alpha, \gamma){}^7\text{Be}$ , and  ${}^{14}\text{N}(p, \gamma){}^{15}\text{O}$ . European nuclear physicists have pioneered this approach and the Gran Sasso facility remains unique in the world. Decades of experiments at surface laboratories using direct and indirect methods



**Figure 4.** The Gran Sasso underground facility located off the road tunnel under the Italian Apennine mountains is home to LUNA, Europe's unique underground accelerator facility for low energy nuclear astrophysics measurements. Two accelerators have been housed at LUNA to enable nuclear reactions rates to be measured in an environment free from cosmic rays and other environmental radiation. This has enabled measurements to be extended to the low energies associated with stellar nucleosynthesis.

also produced quite complete information on another key reaction:  ${}^7\text{Be}(p, \gamma){}^8\text{B}$ .

While the H-burning phase can nowadays be considered, at least from the nuclear physics point of view, reasonably well understood, much work is still needed to improve the knowledge of the reactions involved in the subsequent phases of hydrostatic burning. The most relevant cases are briefly discussed in the following:

The  ${}^{12}\text{C}(\alpha, \gamma){}^{16}\text{O}$  reaction is considered to be the most important reaction of nuclear astrophysics. It plays a crucial role in the evolution of stars during the helium-burning phase and determines the abundance ratio between two fundamental elements, carbon and oxygen. This, in turn, influences the nucleosynthesis of elements up to the iron peak for massive stars, the cooling timescale of white dwarfs and the properties of thermonuclear as well as core collapse supernovae. At the typical Gamow peak energy for a helium-burning star,  $\sim 300$  keV, the expected cross section is extremely small ( $10^{-17}$  barn) and therefore outside the reach of any experiment. Experimental data obtained with the best techniques for background reduction extend with good precision down to 1-1.5 MeV above the  $\alpha$  separation threshold. The possibility to get measured data down to 0.5-0.6 MeV should be pursued in the near future.

The third phase in stellar evolution (C-burning) is triggered by the  ${}^{12}\text{C} + {}^{12}\text{C}$  fusion reaction (with a small contribution from  ${}^{12}\text{C} + {}^{16}\text{O}$ ). This reaction rate is a key parameter determining the evolution of massive stars. It also affects the ignition conditions and time scales of type Ia supernovae which, unlike core-collapse supernovae, are believed to be the result of explosive thermonuclear runaway in binary stellar systems, where material is accreted on the surface of a white dwarf from a less evolved companion.

The list of cases of astrophysical interest is completed by several reactions as:  ${}^{17}\text{O}(p, \gamma){}^{18}\text{F}$ ,  ${}^{18}\text{O}(p, \gamma){}^{19}\text{F}$ ,  ${}^{22}\text{Ne}(p, \gamma){}^{23}\text{Na}$ ,  ${}^{23}\text{Na}(p, \gamma){}^{24}\text{Mg}$ ,  ${}^{26}\text{Al}(p, \gamma){}^{27}\text{Si}$ ,  ${}^{33}\text{S}(p, \gamma){}^{34}\text{Cl}$ ,  ${}^{22}\text{Ne}(p, \gamma){}^{23}\text{Mg}$ ,  ${}^{14}\text{C}(\alpha, \gamma){}^{18}\text{O}$ ,  ${}^{15}\text{N}(\alpha, \gamma){}^{19}\text{F}$ ,  ${}^{18}\text{O}(\alpha, \gamma){}^{22}\text{Ne}$   ${}^{14}\text{N}(\alpha, \gamma){}^{18}\text{F}$ . Most of them could be studied in an underground laboratory or in surface laboratories by exploiting indirect approaches and/or recoil separator based techniques.

The sequences of reactions between the nuclei in a star described above are not the only means by which heavier elements are built up. About half of the element abundances between iron and bismuth are produced via slow neutron capture nucleosynthesis (s process) during the hydrostatic burning phase of a star. Starting at iron-peak seed nuclei, the s-process mass flow follows the neutron rich side of the valley of stability via a sequence of neutron captures and  $\beta^-$  decays. According

## 4.4 Nuclear Astrophysics

---

to the modern picture of the s-process two components, connected to different stellar sites, contribute. The main component produces nuclei with masses between 90 and 209 and refers to the He shell burning phase in evolved AGB stars, whereas the weak component contributes only to the mass region below mass number 90 and takes place during helium-core and carbon-shell burning in massive stars.

Since the s process involves mainly neutron capture rates of stable nuclei, a solid data base has been established in the last decades. This has allowed testing and refining stellar models with the result that the main s process is certainly one of the best understood nucleosynthesis processes from the nuclear physics point of view. However, there are still many questions waiting for answers. Due to the major improvement in astrophysical models being able to describe the details of He-shell flashes in AGB stars (the site of the main s-process), there is an unprecedented demand for highly precise and accurate neutron capture cross sections at s-process energies.

One experimental challenge in the future will be the measurement of neutron capture cross sections on radioactive nuclei. This is required for the analysis of branchings along the s-process path, which occur whenever the neutron capture times of nuclei are comparable to their stellar  $\beta$ -decay half-lives. The determination of the branching ratio gives insights into the physical conditions in the interior of the star and provides the tools to effectively constrain modern stellar models. Neutron capture measurements of branch point nuclei are especially demanding, since they require the elaborate production and preparation of radioactive samples and neutron production facilities with extremely high fluxes in the keV region to cope with the small available sample masses.

More investigation is also required in the region between Fe and Ba. Current s-process models cannot explain the observed high abundances of the typical s elements Sr, Y, and Zr in halo, thick disk and thin disk stars with low metallicity. New processes such as for example the lighter element primary process (LEPP) or the  $\nu p$  process have been suggested. Several processes obviously contribute to the nucleosynthesis of medium-heavy nuclei. In order to disentangle the various processes and to identify possible astrophysical sites the individual contributions have to be identified and the determination of the weak s-component is a natural first step. However the neutron capture cross sections for lighter nuclei are very small and most measurements in this region show large uncertainties. Therefore these rates should be re-measured with improved techniques. This leads, together with the existing stellar model uncertain-

ties of massive stars, to large variations in the prediction of the s-abundances of the weak component.

Besides neutron capture cross sections,  $(\alpha, n)$ -reactions on  $^{13}\text{C}$  and  $^{22}\text{Ne}$  also play a vital role, since they act as the neutron sources. In particular, the weak s process in massive stars and the subsequent stellar evolution depends critically on the rate of the  $^{22}\text{Ne}(\alpha, n)^{25}\text{Mg}$  reaction. The cross sections are very small in the astrophysically interesting energy region and despite all the progress made in the past, further efforts to reduce the uncertainties are required. Light nuclides can act as neutron poisons, removing neutrons from the s-processing, even when they have tiny neutron capture cross sections but are abundant in the stellar plasma, e.g.,  $^{12}\text{C}$  and  $^{16}\text{O}$  with cross sections of few tens of  $\mu\text{b}$ . This poses a challenge to experiment due to the small reaction rates, but these cross sections must be measured.

### Cataclysmic events and explosive thermonuclear burning

Classical novae (CNe), type Ia supernovae (SNIa), and type I X-ray bursts (XRBs) are explosive stellar events that take place in close binary systems. They consist of a compact object (a white dwarf, in the case of CNe and SNIa; a neutron star, for XRBs), and a large Main Sequence (or a more evolved) star. The companion overfills its Roche lobe and matter flows through the inner Lagrangian point, leading to the formation of an accretion disk around the compact star. A fraction of this H- (He-) rich matter ultimately ends up on top of the compact star, where it is gradually compressed up to the point when ignition conditions to drive a thermonuclear runaway (hereafter, TNR) are reached.

### Classical Novae

Nuclear physics plays a crucial role in the course of nova explosions. As material from the accretion disk piles up on top of the (CO or ONe) white dwarf, the first nuclear reactions take place. This is followed by a rise in temperature since degenerate conditions prevent the star from readjusting the hydrostatic equilibrium by an envelope expansion and, as a result, a TNR ensues. At very early stages of the explosion, the main nuclear activity is driven by  $^{12}\text{C}(p, \gamma)^{13}\text{N}(\beta^+)^{13}\text{C}(p, \gamma)^{14}\text{N}$ . But as the temperature rises, the characteristic time for proton capture reactions on  $^{13}\text{N}$  becomes shorter than its  $\beta^+$ -decay time, initiating the hot CNO cycle. Very little CNO breakout is expected. Instead, the nuclear activity in the Ne-Ca region, characteristic of ONe novae, is probably driven by mixing at the core-envelope interface during the TNR. The likely nucleosynthetic endpoint is located around Ca.

Significant uncertainties remain for certain key reactions involving radioactive nuclei, particularly,  $^{18}\text{F}(p,\alpha)^{15}\text{O}$ ,  $^{25}\text{Al}(p,\gamma)^{26}\text{Si}$ , and  $^{30}\text{P}(p,\gamma)^{31}\text{S}$ . The former reactions play a role in the predicted abundances of the cosmic  $\gamma$ -rays sought in satellite telescope missions, such as the 511 positron annihilation line. The latter reaction is key to understanding the production of elements such as Cl and Ar in the ejecta of ONe novae. Accompanying these nuclear physics uncertainties, are uncertainties in novae modelling regarding the mechanism responsible for mixing at the core-envelope interface – this is required to explain the large metallicity enhancements inferred for the ejected nova shells. This and other aspects will require further development of multidimensional hydrodynamic codes – to date most of our knowledge on the nature of classical nova outbursts relies on spherically symmetric models.

### Type I X-Ray Bursts

With a neutron star as the underlying compact object site for the explosion, peak temperatures and densities in the accreted envelope reach quite high values:  $T_{\text{peak}} > 10^9$  K, and  $\rho \sim 10^6$  g.cm $^{-3}$ . These values are about an order of magnitude larger than in a typical classical nova outburst and consequently break-out from the hot CNO cycles may occur by the onset of the  $^{15}\text{O}(\alpha,\gamma)^{19}\text{Ne}$  reaction, and  $(\alpha,p)$  reactions on  $^{14}\text{O}$  and  $^{18}\text{Ne}$ .

The burst conditions depend on a delicate balance between these uncertain nuclear burning rates and the fuel supply from the in-falling envelope material. Following breakout, the  $\alpha p$  process ensues. Here, detailed features of X-ray burster light curves have been linked to a small number of  $(\alpha,p)$  reactions on even-even  $T_z = -1$  nuclei, whose reaction rates are highly uncertain, but depend critically on level densities at high excitation energies. Predicting these level densities in this region is a current theoretical challenge for microscopic calculations for nuclei in this region, going beyond the traditional statistical model (Hauser-Feshbach) approach. This latter method is expected to become even more questionable as the proton-drip line is approached in the subsequent  $rp$ -process, where level densities become very low in the burning regime. In such regions of medium to heavy highly proton-rich nuclei, it will be important to obtain nuclear structure information on masses, half-lives and excited states. Although a large number of nuclei are involved in the  $rp$ -process, sensitivity studies have shown that only a relatively small number of nuclear reactions ( $\sim 30$ ) have significant effects, most notably the  $^{65}\text{As}(p,\gamma)$  and  $^{61}\text{Ga}(p,\gamma)$  reactions. The mass of  $^{65}\text{As}$  is particularly critical for determining the nucleosynthetic flow in a range of X-ray burster models, since it bridges a potential waiting point around the  $N=Z$  nucleus  $^{64}\text{Ge}$ .

The specific location of the  $rp$ -process termination point is still a matter of debate – recent nuclear structure studies around this region suggest that photodisintegrations in the SnSbTe-mass region are not efficient enough to halt the extension of the nuclear path. It still remains uncertain if material can be ejected from X-ray bursters and contribute to the wider galactic abundances. From the modelling point of view, probably the most critical issue is to assess whether a mechanism, such as a radiation-driven wind at late stages of the TNR, can achieve this effect.

### Supernovae

Stars with more than about 8 solar masses continue their burning phases after Helium burning. Massive stars with more than about 10 solar masses go through the advanced burning stages hydrostatically whereas stars in the range between 8 and 10 solar masses exhibit degenerate conditions in the core and cannot reach stable burning anymore. They undergo the advanced burning phases in an incomplete manner during collapse of the central part of the star. Ultimately, the more massive stars face core collapse with subsequent supernova explosion (ccSN). Silicon burning produces a stellar core, composed of nuclei in the Ni-Fe region, which starts contracting as more and more mass is accumulated, while the Si burns in a surrounding shell. Increasing density also increases the Fermi energies of the electrons in the plasma and allows electron captures on nuclei. The loss of electrons leads to a further decrease in the pressure and the contraction turns into a collapse with rapidly increasing density, allowing further electron captures. The collapsing core decouples into an inner and an outer core. The inner core collapses rapidly to a proto-neutron star with the outer core following more slowly. During the early phases of the collapse neutrinos produced by electron captures leave the core freely, carrying away energy and keeping the temperature relatively low. Consequently, as the density grows, very massive neutron-rich nuclei are produced through electron captures.

Under supernova conditions electron captures are dominated by Gamow-Teller (GT) transitions. Experimentally, these transitions can be studied by charge-exchange experiments at low momentum transfer. With the advent of experiments based on the  $(d,^2\text{He})$  reaction at KVI, it has been possible to obtain high resolution data necessary for the constraint of theoretical calculations of electron capture rates on iron group nuclei. Consequently, it has been possible to validate theoretical calculations of weak interaction rates based in the interacting shell model in the mass range  $A=45-65$ . Heavier nuclei become important as the collapse pro-



## 4.4 Nuclear Astrophysics

---

ceeds and becomes fully dynamical. Nuclei with proton numbers  $Z < 40$  and neutron numbers  $N > 40$  are produced for which GT+ transitions are blocked in an independent particle model picture. However, many body correlations and finite temperature excitations provide an unblocking of the GT strength. Here, it will be necessary to develop theoretical approaches that consistently treat both correlations and finite temperature in the description of weak transitions and include both contributions from GT and forbidden transitions. From the experimental point of view it will be necessary to extend charge exchange experiments to unstable nuclei using radioactive ion-beams and inverse kinematics techniques.

The series of electron captures stop once the density becomes large enough ( $\sim 10^{12}$  g/cm<sup>3</sup>) for neutrinos to be trapped allowing neutrino absorption (the inverse of electron capture) to take place. In addition, besides neutrino-electron scattering, inelastic neutrino-nucleus interactions become important for the thermalisation of neutrinos. Reliable estimates of these cross sections require the knowledge of the GT and first-forbidden spin dipole response at finite temperature. Theoretical calculations can be constrained using the similarities between the weak and electromagnetic excitations of the nucleus. In particular, M1 data can be used to constrain the GT<sub>0</sub> response. However, a direct determination of neutral current neutrino-nucleus cross sections is certainly desirable.

Once the core reaches nuclear matter densities, the collapse is suddenly stopped and a shock wave is launched that completely dissociates the outer core material. In this way, the shock wave becomes a standing shock wave subject to several hydrodynamical instabilities. Some of these instabilities will become accessible experimentally to the NIF (USA) and PHELIX (GSI/FAIR, Germany) facilities. A full understanding of the explosion mechanism requires multidimensional radiation hydrodynamics simulations with accurate neutrino transport and state of the art nuclear physics input. Different simulations have shown that the post bounce evolution is rather sensitive to the Equation of State (EoS) and in particular to the symmetry energy and compression modulus (see discussion on neutron stars). The EoSs presently used in supernova simulations are rather schematic. More microscopic, self-consistent EoSs constrained by the experimental data accumulated in the last decade should be developed and implemented in simulations. At the same time the recent suggestion that a transition to quark matter can take place during the early post-bounce evolution should be further explored and the observational consequences determined.

As the shock wave propagates out from the core, explosive nucleosynthesis takes place in the higher lying

layers of the star. Different classes of nuclei are produced in the different regions, providing a way to probe conditions in the layers of a star. The yields of some of the nuclei (such as <sup>44</sup>Ti, <sup>56</sup>Ni) are sensitive to the actual explosion mechanism. This offers the possibility to study details of the explosion mechanism by combining multidimensional models with improved nuclear input and observations with current (e.g., INTEGRAL) and future (e.g., NASA's NuSTAR)  $\gamma$ -ray satellites.

The detection of neutrinos from SN1987 helped to confirm the basic features of supernova physics and in particular the important role of neutrinos. A future supernova detection in all neutrino flavours with accurate neutrino energy determination will provide valuable information about the explosion mechanism. The nuclear physics input enters in several ways. Firstly, neutrinos are mainly emitted from regions with subnuclear densities whose properties, equation of state and composition, are not fully understood, particularly at the finite temperature conditions relevant for supernova. Secondly, once they are emitted they travel through regions where their interaction with nuclei can produce modifications in the neutrino spectra. Finally, they are detected on earth via the interaction of neutrinos with the nuclei present in the detector material. Consequently, in order to fully exploit the potential of a future neutrino detection it becomes necessary to have reliable estimates of neutrino-nucleus cross sections constrained by experimental measurements. In this sense, the construction of a dedicated detector for the measurement of neutrino-nucleus cross sections at the future European Spallation Source could be a very valuable tool. This is important not only for improving our understanding of supernova physics but also for disentangling purely nuclear effects from oscillation effects due to the propagation of neutrinos through the stellar mantle, enabling us to learn about neutrino properties including the mass hierarchy and mixing angle.

As a result of the explosion a neutron star is formed. Initially, this protoneutron star is very hot and cools emitting neutrinos of all flavours. These neutrinos interact with the matter in the outer layers of the neutron star producing an outflow of matter known as neutrino-driven wind. Depending on the neutrino and antineutrino spectra and luminosities the outflows can be either proton or neutron-rich. Proton-rich outflows constitute the site of the recently predicted  $\nu p$ -process. In this scenario the cooling of the ejected matter results in the formation of  $N=Z$  nuclei, mainly <sup>56</sup>Ni and <sup>64</sup>Ge, with a substantial amount of free protons left. At this moment antineutrino captures on free protons ensure a substantial supply of neutrons that can be captured in the nuclei present, mainly by (n,p) reactions, and allow for the matter flow beyond <sup>64</sup>Ge in the short dynamical time scales of super-



---

nova ejecta (a few seconds). In this way, neutron deficient nuclei up to mass  $A \sim 100$  could be synthesized. Thus, it is also a possible production mechanism for light p-nuclei like  $^{92,94}\text{Mo}$  and  $^{96,98}\text{Ru}$ . The details of  $\nu\text{p}$ -process nucleosynthesis still need to be explored including both the nuclear physics and astrophysical aspects.

For many years the neutrino-driven wind has been considered as the favoured site for r-process nucleosynthesis. However, all simulations so far have failed to obtain the conditions necessary for the production of heavy r-process elements including U and Th. There may be some important physical ingredient still missing in the models, but alternative sites should also be considered for the production of r-process elements. These may be associated to the formation of a rotating neutron star after the supernova explosion and the appearance of an accretion disk and jets; the merging of two neutron stars; and the ejection of neutron-rich matter from black hole accretion disks associated with  $\gamma$ -ray bursts. A major step in solving the r-process puzzle has been the detection of r-process elements in a few very metal-poor stars located in the halo of the galaxy. These stars formed a long time ago when the galaxy was still iron poor and provide us with a snapshot of the nucleosynthesis yield resulting from, hopefully, a single nucleosynthesis event. All observations so far show that the production of r-process elements with  $A > 130$  is very robust and results in elemental abundances consistent with the solar r-process abundances. Elements with  $A < 130$  show much larger variations from star to star suggesting the need for two different processes responsible for the production of elements heavier and those lighter than  $A = 130$ . This is also supported by the abundances of some extinct r-process nuclides (e.g.  $^{129}\text{I}$  and  $^{182}\text{Hf}$ ) in the early Solar System, inferred from measurements of isotopic anomalies in meteoritic materials, which cannot be explained by one single process. Large-scale astronomical surveys of r-process stars, and further studies of meteoritic material, will help to clarify the situation and will help in understanding the enrichment of the galaxy with heavy elements.

From the nuclear physics point of view the r-process is a sequence of neutron captures, photodissociations and  $\beta$ -decays occurring at such large neutron densities that nuclei near the neutron drip line are produced. Most of these nuclei never have been produced in the laboratory and consequently their properties remain largely unknown. In order to interpret future observations it will be necessary to compare them with predictions of different r-process model calculations. These require reliable nuclear input in order to relate the observed abundances with the particular astrophysical conditions of the r-process site. A dramatic change in our understanding of the r-process is expected to occur once

future radioactive beam facilities become operational, as they will produce a wealth of r-process nuclei and consequently greatly constrain the astrophysical models. To fully exploit the potential offered by these facilities, a concerted effort between experimental and theoretical efforts, involving both the nuclear and astrophysical modelling, will be required.

Hydrostatic shell burning continues undisturbed in the outer envelope of the massive star until the explosion shockwave has passed through and leads to a sudden increase in temperature and density. The peak temperature drops drastically as we move to outer regions of the envelope. Therefore explosive nuclear burning affects only the O/Ne shell and possibly the C shell but He- and H-shell burning are barely touched. In the affected layers, the explosive burning leads to a redistribution of abundances because unstable nuclei around stability can also participate in reactions due to the increased reaction rates. Knowledge of these abundance modifications are especially important with respect to abundance data from meteoritic inclusions, thought to have been formed in ccSN remnants. Explosive burning also affects the amount of long-lived radioactivities in remnants, e.g.,  $^{26}\text{Al}$ ,  $^{60}\text{Fe}$ ,  $^{44}\text{Ti}$ , and  $^{56}\text{Ni}$ , with the latter stemming from the deepest ejected layers. The  $\gamma$ -radiation emitted in the decay of these can be detected with present and future  $\gamma$ -ray observatories and provides an important anchor for comparison of models with data. Some of them may even enter our Solar System and might be detected in terrestrial archives (e.g. the detection of  $^{60}\text{Fe}$  in the deep sea FeMn crust) providing complementary information on the production of these nuclides.

Although the neutrino fluxes in the outer layers are not as strong as in the inner regions they are still large enough to produce substantial changes in the composition by charge current and neutral current interactions. These neutrino interactions constitute the basics of the  $\nu$ -process that is expected to contribute to the solar abundances of isotopes like  $^7\text{Li}$ ,  $^{11}\text{B}$ ,  $^{15}\text{N}$ ,  $^{19}\text{F}$ ,  $^{138}\text{La}$ ,  $^{180}\text{Ta}$ .  $\nu$ -process nucleosynthesis studies require reliable estimates of charge and neutral current neutrino interactions in nuclei like  $^4\text{He}$ ,  $^{12}\text{C}$ ,  $^{16}\text{O}$ ,  $^{20}\text{Ne}$  and charge current reactions on  $^{138}\text{Ba}$  and  $^{180}\text{Hf}$ . In addition, the production of  $^{180}\text{Ta}$  requires the determination of the population of the ground state and isomeric state and their dependence on the temperature of the astrophysical environment.

A further important process in explosive burning in the envelope is the p-process, required to produce proton-rich, stable nuclides beyond Fe which cannot be reached by the s- and r-processes. The common picture is that these are synthesized by photodisintegration of pre-existing s- and r-process nuclei in the outer layers. Photodisintegration at temperatures of 2-4 GK starts with

## 4.4 Nuclear Astrophysics

neutron emission. At some point in an isotopic chain, proton and/or  $\alpha$  emission will become faster and deflect the reaction path. After the shockwave has passed, the proton-rich, unstable nuclei can decay back to stability. Current models cannot consistently explain the formation of all p-nuclei. Nuclear data is largely missing in the relevant energy range to compute the astrophysical reaction rates for the capture and photodisintegration reactions, even closer to stability where only few measurements are available close to the relevant energy. As the nuclear level density is high, Hauser-Feshbach models can be used to predict cross sections, but the required inputs still need improvement, in particular optical potentials and nuclear levels. The experimental determination of cross sections at the relevant energies would be preferable, for unstable targets with, e.g., decelerated beams at FAIR, or directly in inverse kinematics at SPIRAL2 using a recoil separator like FULIS. It has to be mentioned that there is a general shortcoming in the production of  $^{92,94}\text{Mo}$  and  $^{96,98}\text{Ru}$  which may not be solved by improving the nuclear input alone. Alternative production mechanisms and sites have to be explored, such as the  $\nu p$ -process in ccSN or explosive burning in SNIa.

Type Ia Supernovae result from the disruption of a White Dwarf in a binary system (or the merging of two White Dwarfs as a sub-class). The infall of material from the companion star pushes the WD over the Chandrasekhar limit and leads to a collapse and explosion. They are the main Fe factories in the Galaxy and have become important recently as distance indicators for cosmology. Much of the nuclear physics in these sites mirrors that of explosive C and O burning in ccSN. In terms of modelling, the main nuclear uncertainties include  $^{12}\text{C}+^{12}\text{C}$ ,  $^{16}\text{O}+^{12}\text{C}$  and electron captures on nuclei in the iron region necessary to determine the yield of  $^{56}\text{Ni}$ . However, the largest uncertainties are in the astrophysical modelling of the White Dwarf disruption, in particular the speed of the burning flame and the likely transition from deflagration to detonation – subsonic to supersonic burning front.

### Neutron Stars

Born from catastrophic gravitational core-collapse supernovae, neutron stars are the largest nuclear systems found in the universe, with  $\sim 10^{57}$  baryons confined inside a radius of about 10 km. The density in the central cores of neutron stars can exceed several times that found inside heavy atomic nuclei. The properties of such matter remain largely unknown and its theoretical description is one of the most challenging issues of nuclear and particle physics.

About two thousand neutron stars have been detected but many orders of magnitude more are expected to exist

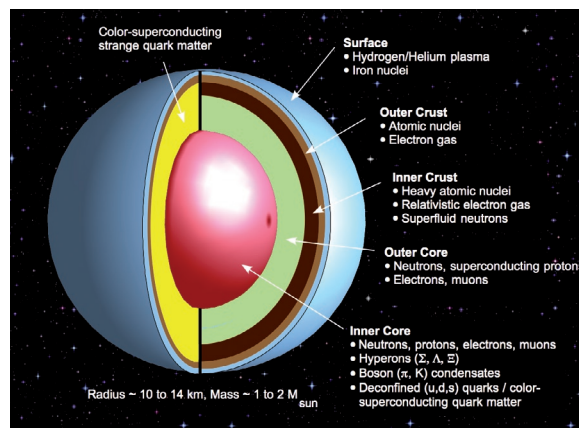

**Figure 5.** The basic structure of a neutron star (F. Weber, SDSU, 2010).

in our Galaxy. Most of them are radio pulsars but various other kinds of neutron stars have been found. Binary pulsars are extremely interesting since neutron star masses can be very precisely measured and various effects predicted by General Relativity can be tested. Several decades of intensive observations from ground-based and space-based instruments have led to the discovery of remarkable phenomena such as quasi-periodic oscillations in low mass X-ray binaries, bursting millisecond pulsars, X-ray superbursts, quasi-periodic oscillations in giant flares from soft- $\gamma$  repeaters and the thermal relaxation of soft X-ray transients. More refined observations are expected to come with the advent of new instruments, such as the International X-ray Observatory (IXO). The development of atomic stellar spectroscopy of neutron stars, together with the improvement in the observational techniques, will allow more accurate measurements of their mass and radius. Neutron stars are also powerful accelerators of high-energy particles as discussed in the section about supernovae. The last two decades have seen the construction of several European (VIRGO, GEO600) and other (LIGO, TAMA300) gravitational-wave interferometers which are now collecting data. More advanced detectors are already under development. Although the interpretation of all these observations is a difficult task, it can ultimately shed light on the intimate properties of matter.

The outermost solid layers of a neutron star represent only a few percent of the star's mass but are directly related to many observable phenomena. The outer crust is formed of a crystal lattice of neutron-rich nuclei immersed in a dense electron gas. Its composition is completely determined by the masses of exotic nuclei with  $Z/A$  reaching  $\sim 0.3$ . Below  $\sim 10^{11}$  g/cm $^3$ , the masses of the nuclei present in the crust have been precisely measured. However at higher densities nuclear masses

have to be calculated. Current microscopic mass tables are based on self-consistent mean-field methods. Over the last few years the accuracy of these models has been significantly improved. However reliably extrapolating these models far beyond the stability valley where they are adjusted requires a better understanding of many-body correlations in finite nuclei. Some neutron stars are endowed with huge external magnetic fields of order  $10^{14}$ - $10^{15}$  G (the internal field could be even stronger). Calculating the properties of the crustal matter in such fields is crucially needed for modeling magnetars.

The inner crust of neutron stars, at densities above  $\sim 4 \times 10^{11}$  g/cm<sup>3</sup> is a unique environment which cannot be reproduced in the laboratory. Here there is believed to be a coexistence of nuclear “clusters” with a neutron liquid. Its structure has been studied with various models, the state-of-the-art being self-consistent mean-field methods. However the underlying effective forces are still very phenomenological and should be more microscopically founded. Transport properties of the neutron liquid in the crust are not well understood even though they are essential for modelling various astrophysical phenomena such as pulsar glitches. In particular, neutrons are predicted to be superfluid at low temperatures. Microscopic studies in neutron matter using different methods lead to different density dependence of the  $^1S_0$  pairing gap. Including the effects of spatial inhomogeneities is even more challenging and essential for determining the interaction between nuclear clusters and superfluid vortices arising from the star’s rotation. The influence of the neutron liquid on the elastic properties of the crust has not been studied so far. However this may be important for interpreting quasi-periodic oscillations recently detected in the giant flares from soft- $\gamma$  repeaters which are believed to be the signature of crust quakes triggered by huge magnetic stresses. Although the nature of the crust-core transition has a strong impact on neutron-star oscillations and possibly on neutron-star cooling, it remains mysterious. Some models predict the existence of nuclear “pastas” while others do not. More realistic many-body simulations are crucially needed.

The crust dissolves into nucleons and leptons at a fraction of the nuclear saturation density  $\rho_0$ . Over the last decades progresses in nuclear many-body calculations have been impressive. The equation of state obtained from both diagrammatic and variational methods are in rather good agreement. The use of phenomenological three-body forces explains in a large part the discrepancy between non-relativistic and relativistic Brückner-Hartree-Fock (BHF) calculations. Despite a consistent treatment of two-body and three-body forces in current BHF calculations, large uncertainties remain at high densities depending on the adopted nucleon-

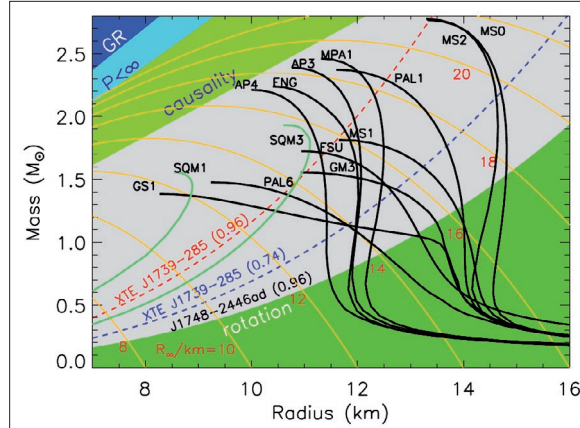

**Figure 6.** The mass-radius relationship of compact stars for different equations of state (from Lattimer *et al.*, Phys. Rep. 442(2007)109).

nucleon potential. The origin of these disparities should be elucidated. The recent development of quantum Monte-Carlo methods is very promising and will provide a benchmark of equation of state calculations in the coming decade. However other microscopic methods will still be needed in order to understand the role of many-body correlations.

Although the composition of dense matter above  $2-3\rho_0$  is essential for determining the structure and evolution of neutron stars, it is still poorly known. In particular, the threshold density for the appearance of hyperons is very uncertain due the scarcity of experimental data about hyperon-hyperon and hyperon-nucleon interactions. Nucleon and/or hyperon superfluidity plays a key role in the thermal evolution of neutron stars, and consequently requires further theoretical studies. Various other species could be present in neutron star cores, for instance pion and kaon condensates. One of the most exciting possibilities is certainly the presence of deconfined quarks. So-called strange stars might even be composed only of quarks even though they seem to be less likely than hybrid stars. A lot of activity has recently been devoted to the study of colour superconductivity, unveiling a very rich phase diagram. However microscopic calculations are hindered by the non-perturbative character of quantum chromodynamics in the conditions prevailing in compact stars. The discovery of a submillisecond pulsar or a compact star with an apparent stellar radius smaller than 11-12 km would be a strong indication in favour of the existence of quark stars. Other observational signatures of a phase transition to quark matter in compact stars include for instance the spontaneous spin-up of pulsars,  $\gamma$  ray bursts with late X-ray emission and long quiescent times or a secondary shock wave in supernova explosions.



## 4.4 Nuclear Astrophysics

---

The development of new radioactive ion beam facilities like FAIR at GSI and SPIRAL2 at GANIL, will allow experimental studies of very exotic nuclei which will have a direct impact on the modelling of compact stars. For instance new mass measurements of neutron-rich isotopes with mass numbers between 80 and 160 would reduce the uncertainties in the composition of the outer crust of neutron stars. This would also put constraints on theoretical models of the inner crust by shedding light on the evolution of nuclear shell structure with isospin asymmetry. This is of paramount importance for determining the properties of the neutron star crust which in turn are needed as inputs for modelling various astrophysical observations. Analysis of multifragmentation in heavy-ion collisions, as well as experimental studies of shape co-existence in drip-line nuclei and Coulomb frustration in heavy nuclei, could help elucidate the physics of nuclear pastas that might exist at the crust-core boundary. Two-particle transfer reactions in exotic halo nuclei may provide insight into the pairing mechanism. Likewise experiments in neutron-rich nuclei are needed in order to pin down the equation of state of asymmetric nuclear matter. The density dependence of the symmetry energy could be probed by analyzing various isospin effects in heavy-ion collisions (for instance isospin diffusion, isoscaling, neutron-proton differential flow or pion production) or by accurately measuring the neutron-skin radius in heavy nuclei. Experiments using parity violating weak neutral interaction, like PREX at Jefferson Lab, seem very promising. The knowledge of the symmetry energy is not only central for calculating the structure of neutron stars but it is also crucial for simulating their cooling. The new facilities mentioned above will also allow efficient production of hypernuclei, like PANDA at FAIR, thus offering new perspectives for studying hyperonic matter. This is necessary for determining the interior composition of neutron stars at densities above  $2-3\rho_0$ . The presence of hyperons can strongly influence the cooling of neutron stars and the damping of pulsations (hence the emission of gravitational waves). In addition they usually soften the equation of state thus lowering the maximum mass dramatically. However this conclusion could be changed by including hyperon three-body forces which remain largely unknown. The properties of matter at very high densities are very uncertain. Hopefully future experiments like CBM at FAIR will provide valuable constraints and will help us to understand the phase transition between hadronic and quark matter.

### 4.4.3 Future Requirements for Experiment and Theory

Europe has a long and distinguished leadership in nuclear astrophysics. For long ISOLDE has provided radioactive beams for study, Louvain-la-Neuve provided the first facility with reaccelerated beams for nuclear astrophysics measurements and LUNA at Gran Sasso the world's first underground accelerator facility for nuclear astrophysics measurements. Forefront work is now being carried out at a range of facilities (<http://www.nupecc.org/pub/hb04/hb2008.pdf>) and there are world leading activities in astrophysics modelling and theory. Moreover the collaborative efforts of the community (aided by NuPECC and the Integrated Activities in FP6 and FP7) have resulted in a new generation of facilities which will be coming online during the present decade (FAIR, SPIRAL2, HIE-ISOLDE and SPES) and which will ensure that Europe can retain its preeminent position.

#### Stable Beam facilities

The figure of merit of a nuclear experiment from the accelerator side requires different technical parameters such as energy, intensity, stability, beam purity and this is complemented by sophisticated target and detection facilities. Only in a very few favourable cases the direct astrophysical factor has been measured in the relevant energy region, otherwise data at higher energies have been extrapolated down to the Gamow region. Such an extrapolation procedure can introduce additional uncertainties in the result. Moreover, even in those few cases for which direct measurements are able to reach the Gamow region, the measured cross section is affected by the electron screening potential which produces an enhancement with respect to the bare-nucleus cross section. Such an enhancement is different in the stellar environment, thus, even in these favourable cases, an extrapolation procedure using higher energy data is required in order to extract the bare-nucleus cross section, which is the needed rate calculations input parameter.

In the last decade indirect methods, like the Asymptotic Normalization Coefficient (ANC) and Trojan Horse Method (THM), were often used in order to avoid the extrapolation procedure. The two methods have been well tested and successfully applied in many reactions involved in different stellar scenarios, and have been supported by relevant theoretical developments. More experimental and theoretical efforts on the application of the two methods are needed. In particular the THM requires further theoretical work to improve the knowledge on the specific features and limitations of the approach.



---

An improvement in the precision of the measurements is also required. This necessary development can be achieved in relatively small laboratories where a well focused and stable beam is available. In addition, the expertise gained can be crucial for further applications with radioactive beams, which until now are characterized by much lower intensities.

To improve the synergy between the existing facilities it is recommended that NuPECC helps to coordinate an active network between the European small scale facilities, not only on the user side but also on the level of technology development. From these coordinated efforts large scale facilities can benefit as well.

Ultimately the key to obtaining the highest quality data, and to be able to measure the weakest reaction rates, is the beam intensity. The ECOS (European Collaboration on Stable ion beams) study revealed the needs for, and described the strategy to deliver, a dedicated high intensity stable beam facility equipped with the latest detection and target technique. The provision of such a facility in Europe, either as a greenfields construction or as a major upgrade to an existing facility, would provide a major boost for nuclear astrophysics measurements. This includes direct measurements, indirect measurements, and the production of unstable nuclei along with measuring their masses in storage rings and traps.

### Radioactive Beam facilities

In hot, dense explosive nuclear astrophysical environments, nuclear reaction rates involving radioactive nuclei become important. RIB facilities will play an essential role in determining key properties and reaction rates of nuclei influencing the energy generation and path of nucleosynthesis in these processes.

ISOL RIB facilities offer the means by which key explosive nuclear astrophysical reactions can be directly measured in the laboratory. These measurements are particularly important for explosive astrophysical environments involving proton-rich species, such as Novae and X-ray bursters where rates can be dominated by a few isolated resonances. Pioneering work has been done in Europe at Louvain-la-Neuve and in Canada at TRIUMF/ISAC, where reaction rates were directly measured using radioactive beams. It is essential that the forthcoming generation of ISOL RIB facilities, including SPIRAL2, HIE ISOLDE and SPES, and in the longer term EURISOL, provide intense, pure beams of low energy (a few hundred keV/u to a few MeV/u) near stability proton-rich nuclei for such direct measurements. The low energy capability is uniquely important for nuclear astrophysics experiments and it is important that the design of the accelerators in these facilities are capable of this. There

is currently a limited capacity for these measurements in Europe and indeed worldwide, due to beam intensity limitations for certain key elemental and isotopic species. In general, measuring these reactions will require accompanying high efficiency, high granularity, charge particle and  $\gamma$ -ray detection systems. High efficiency recoil mass separators with high beam suppression will be required for radiative capture reactions such as  $(p,\gamma)$  and  $(\alpha,\gamma)$ . In some cases direct measurements will not be feasible, e.g.,  $(n,\gamma)$  reactions important for non-equilibrium phases in the r-process in supernovae. Here one can use  $(d,p)$  transfer reactions with ISOL RIBs at  $\sim 10$  MeV/u as surrogates to identify – and to determine spectroscopic factors of – key resonances using a high acceptance spectrometer, such as VAMOS, to tag the nucleus of interest. An analogous approach can be used for measuring  $(p,\gamma)$  reactions on proton-rich nuclei for very low energy resonances with extremely low capture cross-sections.

At the high energy FAIR in-flight RIB facility, photo-disintegration studies of  $(\gamma,p)$  and  $(\gamma,n)$  reactions using the R3B system will also be able to probe important capture reaction processes. A very exciting recent development at GSI has been the use of decelerated beams in the ESR storage ring to measure the  $^{96}\text{Ru}(p,\gamma)$  reaction for the astrophysical p-process close to the astrophysical burning energy regime. This approach could be extended to RIBs to open up a whole new vista of measurements on unstable p-process nuclei using the planned new storage ring (NESR) at FAIR. Future facilities will provide for the first time access to a whole swath of r-process nuclei, where it will be important to measure static properties such as the mass, half-life and decay branches of these rare nuclei using channel selection devices such as the super FRS. Such measurements are vital to address the astrophysical origins of the heavy elements. Similarly, such information will be important for nuclei located in the upper reaches of the astrophysical rp-process. Reaction studies using the high energy beams from FAIR with the R3B, EXL and ELISE systems will offer important insights into the nuclear equation-of-state which will impact on our understating of the structure of neutron stars. For example, giant resonances are sensitive to the nuclear compressibility, and their variation with isospin can be studied on the NESR using the EXL system. Matter distribution measurements from elastic p-scattering can be complemented by charge radii measurements on RIBs using the ELISE e-ring system to extract neutron skin thicknesses – a key parameter for determining the thickness of the crust in neutron stars and also relevant to derive optical potentials for the calculation of reaction cross sections.

In addition to the uncertainties affecting the neutron capture rates, weak interaction properties also suffer

## 4.4 Nuclear Astrophysics

---

from severe theoretical problems. Although all  $\beta$ -decay and EC rates of relevance in the s process are known under terrestrial conditions, the contribution of thermally populated excited states, as well as atomic effects in the strongly ionized stellar plasma can drastically modify the laboratory values. With the exception of isomeric states, the half-lives of excited states cannot easily be measured, and the complexity of the nuclear structure makes the prediction of the required  $\beta^-$  decay matrix elements a real challenge for nuclear theory. Charge exchange reactions like (p,n) can be used to determine  $\beta$ -decay rates under stellar conditions indirectly, which is most valuable for modern s-process networks.

### Underground facilities

At present, only one deep underground facility dedicated to nuclear astrophysics exists: LUNA (Laboratory Underground for Nuclear Astrophysics), located at the Laboratori Nazionali del Gran Sasso (LNGS) in Italy. As outlined earlier, this facility has carried out crucial measurements on key pp chain reactions and the first measurements of CNO-cycle reactions. There is now a recognised need for a higher energy underground accelerator so that the key reactions involved in more advanced stages of stellar burning can be measured, including the neutron sources for the r-process. This requires an accelerator with multi-MV capability.

Recently, the LUNA Collaboration presented to LNGS a Letter of Intent (LoI) for a long-term scientific programme based on a new 3 MV accelerator. The proposed programme received very positive response but the decision of LNGS is still pending. A similar LoI has recently been submitted by a group of European researchers to the Scientific Committee of the Canfranc Laboratory with a scientific programme partially complementary to the LUNA project. The Canfranc Scientific Committee expressed a first positive opinion encouraging the proponents to submit a full proposal. Other underground accelerator projects being considered in Europe are at Boulby in the UK and Praid in Romania and there is also a low background facility being considered at Dresden in Germany. In the USA plans are well advanced for the DIANA project (Dakota Ion Accelerator for Nuclear Astrophysics), a very high intensity, several MV accelerator at the new deep underground DUSEL facility.

The experience of the last 20 years demonstrates that underground nuclear astrophysics is one of the key approaches in the solution of the most important questions still open in the field. The list of experiments in the LoIs quoted above corresponds to a two to three decade project at one MV machine. In some cases the experiments are exceptionally challenging and they will need to be carried out in the framework of a collaboration

of suitable strength. The effort to put into operation a machine of several MV in a European deep underground laboratory should be considered with the highest priority. This could be achieved in the next three to five years with the opportunity to measure one or two key reactions within the next decade. Considering the high scientific interest in measuring several more nuclear reactions, the case could be made to complete the programme with a second facility designed for a complementary set of measurements.

### Neutron measurements

Measurements of neutron capture reactions are essential for a better understanding of the slow neutron capture process (s process). Stellar network simulations require as input neutron capture cross sections for many nuclei along the valley of stability. Cross sections of the lightest nuclei, especially the CNO group nuclei, are important because they act as neutron poison and consume neutrons, which are then not available for the s process. Cross sections for nuclei in the mass range  $56 \leq A \leq 90$  are needed for the weak component and nuclei in the range  $90 \leq A \leq 210$  are crucial for the main component of the s process. There has been a lot of progress in the last decades, which has led to an extensive database that can be used in s-process simulations. However, some neutron capture cross sections, in particular those for unstable nuclei are still not known with sufficient accuracy. This includes for example important branching point nuclei such as  $^{63}\text{Ni}$ ,  $^{79}\text{Se}$ ,  $^{95}\text{Zr}$ , etc. but also neutron capture reactions which lead to the production of certain radioisotopes which can be observed by  $\gamma$ -ray astronomy (e.g.  $^{60}\text{Fe}$ ).

The first milestone of these challenging experiments involves the production and preparation of radioactive targets, which requires the development of hot target handling laboratories, such as the CACAO (Chimie des Actinides et Cibles radioActives à Orsay) which is currently under construction in Orsay. New facilities like FAIR, SPIRAL2, or ALTO could contribute to the production of the radioactive material, either by neutron induced reactions on stable materials or by direct production of neutron rich-nuclei. Finally, next generation neutron time-of-flight facilities such as n\_TOF2 (CERN, Switzerland), SARAF/LiLiT (Weizmann Institute, Israel), LENOS (INFN, Italy), or FRANZ (University Frankfurt, Germany) with unsurpassed neutron fluxes are necessary to perform such measurements.

Indirect methods might also play an important role in the determination of neutron reaction cross sections. The Coulomb dissociation (CD) method would use the virtual photon field in the vicinity of a heavy target nucleus to break a given nucleus into a residual plus

---

a neutron. Application of the detailed balance theorem would then enable the neutron capture cross section to be determined. Since these experiments are performed in inverse kinematics they can also be applied to radioactive beams. This might be a promising approach to measure neutron capture cross sections further away from stability as is needed for the  $r$  process nucleosynthesis. However, this requires high energy radioactive beam facilities with high intensities like FAIR. Transfer reactions like  $(d,p)$  reactions are a very efficient means to measure the spectroscopic factors that are required to determine the resonant and direct capture reaction rates. These transfer reactions should be measured at low energies (5-10 MeV/u) and using high radioactive beam intensities like those provided at the SPIRAL 2 facility. Another method that is used successfully for neutron-induced fission cross sections is the surrogate method. So far, no successful proof of principle could be performed for neutron capture cross sections, but it might be an interesting additional approach.

### Photonuclear measurements

Systematic studies of photon-induced reaction rates relevant for nucleosynthesis have been carried out at bremsstrahlung facilities located at electron accelerators like e.g. ELBE (Dresden, Germany) and S-DALINAC (Darmstadt, Germany) in the last decade. While  $(\gamma,n)$  reactions were studied in a broad mass range only very few  $(\gamma,\alpha)$  and  $(\gamma,p)$  reactions have been measured so far. The ongoing improvements at these facilities will increase the number of accessible reactions during the next years. In addition, cross sections have to be studied energy-resolved to improve the reliability of the nuclear structure input for predictions of reaction rates. Thus, energy-resolved measurements with photons have highest priority for the development of the field and can be achieved using either tagged photons or Laser Compton Backscattering (LCB) sources.

While tagged photons will be available in the astrophysically relevant energy region in the upcoming years at the photon tagger NEPTUN at the S-DALINAC, Darmstadt, Germany, there is a lack of a European LCB source. As such a photon source is also of high interest for nuclear structure purposes it is worthwhile planning the development of a facility outperforming the state-of-the-art setup of the High Intensity  $\gamma$ -ray Source (HIgS, DFELL, Durham, NC, USA). This might be possible in the framework of the Extreme Light Infrastructure ELI that has been initiated in Europe. The centre planned at Bucharest, Romania, is dedicated to nuclear physics including photonuclear physics and should include a LCB source to complete the European portfolio of photon sources for nuclear physics purposes.

Key questions of heavy element nucleosynthesis often correspond to studies of unstable nuclei. In that case, photonuclear reactions can be investigated using Coulomb dissociation in inverse kinematics at the LAND setup at GSI, Germany, and in future at the R<sup>3</sup>B setup at FAIR, Germany. The combination of results from these experiments on exotic nuclei with high-precision data on stable nuclei using bremsstrahlung and LCB photons will significantly contribute to an appropriate database for the understanding of nucleosynthesis.

### Accelerator Mass Spectrometry approaches

The use of Accelerator Mass Spectrometry (AMS) in the astrophysical context is twofold. Firstly, AMS can be used to perform measurements of reactions leading to long-lived radionuclides. These complement experiments at dedicated nuclear physics facilities or underground laboratories, in particular for measurements of neutron capture reactions for the  $s$ -process, proton and  $\alpha$ -induced reactions for various burning phases or photodisintegration rates for the  $p$ -process. AMS is used to quantify the long-lived reaction products following an irradiation with neutrons, charged particles or photons. Amongst others the experiments will be performed in close collaboration with neutron facilities (e.g. FRANZ) or high-intensity photon sources (e.g. S-DALINAC).

Secondly, the superb sensitivity and background suppression can be used for detection of very minute amounts of supernova-produced radionuclides in terrestrial archives and to provide information on isotopic anomalies in pre-solar grains found in meteorites. Some of these activities are already supported within the EUROGENESIS programme.

Currently, there are about 80 AMS facilities operational worldwide; with more than 30 facilities

Europe has the largest concentration of AMS accelerators. Several laboratories have programmes related to astrophysical research with the groups in Munich (GAMS) and Vienna (VERA) playing a leading role. It is important that these activities receive continued support. In particular, having at least one large tandem accelerator (>10 MV) available for AMS is crucial for measurements of heavier nuclei ( $A > 50$ ) where high isobar suppression is necessary.

On the other hand, developments towards smaller and simpler AMS systems (as it is pursued at ETH Zurich) are also beneficial for astrophysical research because these systems often allow measurements with higher efficiencies, which is particularly crucial for the detection of minute amounts of long-lived radionuclides in terrestrial archives or activated materials. Additionally,

## 4.4 Nuclear Astrophysics

experience with particle detection and background suppression at very low energies is beneficial for direct measurements at astrophysical relevant energies using recoil separators.

### Developments in nuclear theory and astrophysical modelling

Advances in nuclear theory for astrophysics will be strongly coupled to the development of improved nuclear structure theory as described elsewhere in this report. However, there are a number of specific details which have to be considered additionally for nuclear astrophysics or which emphasize slightly different aspects than those in pure nuclear theory. Nuclear structure models have to predict nuclear properties required for the calculation of astrophysical reaction rates (weak rates,  $\beta$  decays, rates involving the strong and electromagnetic interaction) and the behaviour of nuclear matter at various temperatures and densities. Nuclear burning produces a large range of nuclei from proton- to neutron-dripline and the goal is to consistently describe their properties. In general, reaction rates are very sensitive to the nuclear input and current models lead to quite different predictions far from stability. For equilibrium conditions (such as the proposed  $(n,\gamma)$ - $(\gamma,n)$  equilibrium in the r-process or the Nuclear Statistical Equilibrium (NSE) reached in deep layers of ccSN), the required input reduces to separation energies, ground state properties, and partition functions. For non-equilibrium reactions (and weak reactions are rarely in equilibrium) additional information is required, as outlined below. An additional complication arises from the fact that nuclei are in thermal contact with the astrophysical plasma and thus nuclear properties and reactions are altered through the influence of thermal population or de-population of excited states.

The description of reactions relevant for nuclear astrophysical applications greatly depends on the density of levels available. Several electro-weak processes involving light nuclei have been computed in the context of Effective Field Theory. These include an accurate determination of the pp and hep reactions for hydrogen burning in the Sun and the calculation of the response of deuterium to neutrinos necessary for the measurement of solar neutrinos at the Sudbury Neutrino Observatory (SNO). Effective Field Theory approaches have also been used for the determination of realistic nucleon-nucleon interactions of a quality similar to that obtained by more phenomenological approaches. From the nuclear astrophysics point of view a recent relevant development has been the extension of *ab-initio* approaches to the description of astrophysically relevant reactions. Several reactions including the  ${}^2\text{H}(\alpha,\gamma){}^6\text{Li}$ ,  ${}^3\text{H}(\alpha,\gamma){}^7\text{Li}$ ,  ${}^3\text{He}(\alpha,\gamma){}^7\text{Be}$  and  ${}^7\text{Be}(p,\gamma){}^8\text{B}$  have been computed within the Variational Monte Carlo and No-Core Shell Model approaches.

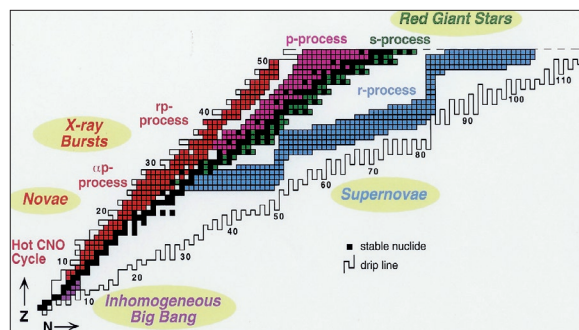

Figure 7. This figure from a review by Smith and Rehm (Ann. Rev. Nucl. Part. Sci. 51(2001)130) illustrates how nuclear astrophysics modelling requires theoretical information is across the chart of nuclei.

Currently, both approaches assume a potential model for the description of scattering states and derive the spectroscopic information of the states involved from a full *ab-initio* calculation. The first attempts to extend the No-Core Shell Model and the Coupled Cluster Model to open quantum systems are under way and it is expected that in a few years the first fully *ab-initio* calculations of nuclear reactions involving light nuclei will become available.

Light nuclei are characterized by the existence of states with a clear cluster structure. The Hoyle state in  ${}^{12}\text{C}$  at an excitation energy of 7.764 MeV is probably the most famous one as it determines the triple  $\alpha$  rate. These states can be described by the nuclear cluster model that allows for a description of nuclear bound and scattering states under the assumption that the many body wave function can be approximated by an antisymmetric cluster product state. An exciting recent development has been the extension of cluster models to include more flexible wave functions and realistic nucleon-nucleon interactions. These improved models include the Antisymmetric Molecular Dynamics and the Fermionic Molecular Dynamics (FMD) and have been quite successfully applied for the description of nuclear structure problems. These models are very promising tools for the description of astrophysically important nuclear reactions as they combine the flexibility in the choice of basic wave functions for bound and scattering states with the virtue of accounting for the relevant degrees of freedom and correlations among nucleons. A first exploratory calculation of the  ${}^3\text{He}(\alpha,\gamma){}^7\text{Be}$  reaction in the FMD approach is already available and additional applications are expected in the future.

For medium and heavy nuclei where the density of states is high enough and many resonances contribute, the most frequently used model is the Hauser-Feshbach approach. The majority of reactions around stability in early, advanced, and – to a certain extent – explosive



---

burning can be treated in such a statistical reaction model, averaging over resonances and individual transitions. It can describe reaction cross sections as long as the required input (masses, low-lying states, level densities, optical potentials,  $\gamma$ -strengths, fission barriers) are provided or predicted by other models. Even at stability, the astrophysically relevant low interaction energies pose a challenge, as there are few data to constrain the input and also other reaction mechanisms may compete. This is especially true for explosive burning producing nuclei far from stability, with low level densities at the compound formation energy. Where the Hauser-Feshbach model is applicable, the emphasis is on a reliable prediction of the input, both at low interaction energies and far away from stability. Currently, this is done by macroscopic-microscopic models or by fully microscopic models.

Both ground and excited states and transitions among them can be accurately described by the interacting shell-model which takes all correlations among valence nucleons into account. This model can even be used under finite temperature conditions provided the temperature of the environment is low enough to allow for a state by state calculation. Currently, due to computational limitations, the shell-model is restricted to light or intermediate mass nuclei and to nuclei with a single closed shell, like *r*-process waiting point nuclei. Extensions of this model for heavy nuclei are certainly needed for future astrophysical applications and to derive the nuclear physics input necessary for Hauser-Feshbach calculations. For the description of nuclei near the drip-line it is necessary to supplement the standard shell-model by a correct treatment of the continuum. This can be achieved within the Shell-Model Embedded in the Continuum and Gamow Shell Model approaches. These approaches will allow for the calculation of reaction rates for nuclei where the density of levels is so low that the Hauser-Feshbach approach is not applicable any more.

Several astrophysical applications and in particular the description of weak processes relevant for supernova evolution require the consistent treatment of finite temperature and correlation effects, making the Shell-Model Monte Carlo (SMMC) the natural choice for the description of thermal properties of nuclei. A hybrid model that combines SMMC calculations with the Random Phase Approximation (RPA) approach has been used for the calculation of electron capture rates for nuclei with  $A > 65$  showing that electron capture on these nuclei determine the evolution of the core of massive stars during the collapse phase prior to the supernova explosion. Future applications will require the development of theoretical models that allow for the calculation of the relevant rates in a thermodynamic consistent way. First attempts along this direction have already been done by extending the

proton-neutron Quasiparticle RPA at finite temperatures by the thermofield dynamics formalism. Extensions of the model to more realistic interactions and the inclusion of correlations beyond RPA are expected in the future.

Global calculations of nuclear level densities are either based on phenomenological approaches like the back-shifted formula or combinatorial models. These models describe the known data rather well. However, with the development of new experimental techniques based on wavelet analysis of giant resonances that allow for the extraction of level densities of states with good parity and angular momentum, it is desirable to derive the level densities in a fully microscopic approach. Shell-Model Monte Carlo calculations have been very successful in the description of level densities for medium-mass nuclei. A future tackling of the sign problem inherent to fermionic Monte Carlo calculations will permit the use of realistic interactions and consequently an improved description of level densities.

The description of ground state properties and particularly masses for medium and heavy nuclei is currently based on variations of the Density Functional Theory. Hartree-Fock-Bogoliubov calculations using the Skyrme parametrization of the density functional have recently been able to predict the known masses with a root-mean-square deviation below 600 keV. The first calculations based on the non-local Gogny parametrization have been performed recently. The microscopic nature of these calculations make them the natural choice for extrapolations far from the region of known nuclei as demanded by *r*-process calculations. Nevertheless, alternative approaches based on the macroscopic-microscopic model and microscopically inspired mass formulas like the Duflo-Zuker should also be considered given their current success in predicting known masses. Future applications of mean-field approaches will focus not only on the calculations of masses but also on the evolution of single particle energies. Currently, different functional parametrizations predict very different single-particle properties. However, a correct description of these properties is very important for the determination of direct contributions to capture reactions that are expected to be important in the *rp*-process and *r*-process far from stability.

The understanding of *r*-process nucleosynthesis represents one of the largest challenges in nuclear astrophysics. *r*-process calculations require the determination of different nuclear properties of several thousand nuclei. Most of these nuclei have never been produced in the laboratory and consequently their properties and relevant reactions must be determined theoretically. This includes neutron captures, photodissociations and  $\beta$ -decays. Additionally, in environments with large neutron-to-seed ratios, fission reactions including neu-

## 4.4 Nuclear Astrophysics

tron-induced fission,  $\gamma$ -induced fission,  $\beta$ -delayed fission and spontaneous fission become important and should be supplemented with reliable predictions of fission yields. A basic input for the calculation of neutron capture rates is the  $\gamma$ -strength function. Several experiments and theoretical calculations have shown the appearance of a new low energy mode in neutron-rich nuclei known as the pygmy dipole resonance. Future Coulomb dissociation experiments will improve our understanding of this mode and together with theoretical calculations help to determine their impact in neutron capture rates and r-process nucleosynthesis. It should be noted that both experiments and current theoretical models determine the  $\gamma$ -strength distribution built in the ground state of the nucleus. However, in many cases the capture cross section is dominated by  $\gamma$  transitions to excited states in the nucleus. Currently, it is assumed that the  $\gamma$ -strength distribution of excited states fulfils the Brink hypothesis, which states that the strength depends only on the  $\gamma$  energy and not on the nuclear state. The validity of this approximation for the astrophysically relevant  $\gamma$ -energies, 2-3 MeV, is by no means warranted and consequently it will be necessary to develop theoretical models for the calculation of  $\gamma$ -strength functions on excited states of the nucleus.

The  $\beta$ -decay of r-process nuclei determines the speed at which the nucleosynthesis flow moves from light r-process nuclei to heavy nuclei. Experimentally,  $\beta$ -decays of r-process nuclei have been determined for only a few key nuclei around the N=50 and N=82 shell closures. These include  $^{78}\text{Ni}$ ,  $^{130}\text{Cd}$  and  $^{129}\text{Ag}$ . These measurements have helped to greatly constrain theoretical calculations for these nuclei that are currently based on a variety of approaches including the Shell-Model, Density Functional plus QRPA, macroscopic-microscopic models plus QRPA, HFB plus QRPA, and relativistic mean-fields plus RPA. Most of the theoretical calculations are currently limited to spherical nuclei. Extensions of the different models to deformed nuclei are consequently necessary. The recent developments of new in-beam analysis techniques have contributed to the determination of  $\beta$ -decay half-lives of nuclei approaching the N=126 r-process region. The use of these techniques together with progress in high intensity Uranium beams will open to experiment the so far unknown N=126 r-process nuclei. This is particularly relevant as current theoretical predictions have a large spread in values. At the same time it is expected that first-forbidden contributions will contribute significantly, a prediction that needs to be confirmed experimentally. Future experiments are expected to provide valuable information about the evolution of the N=82 and N=126 shell closures far from stability and the impact on r-process nucleosynthesis. In addition, the development of new fragment separators will open to experimental study

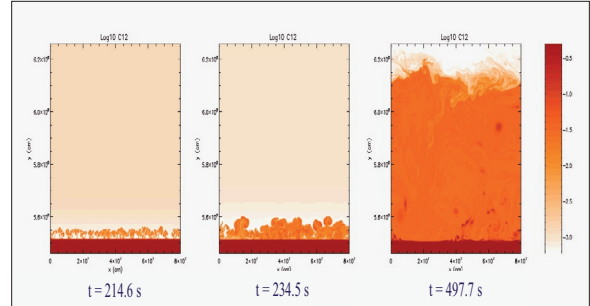

**Figure 8.** 2-D simulations of mixing at the core-envelope interface during nova outbursts (from Casanova *et al.* (2010), A&A, in press).

the region of neutron-rich nuclei beyond Uranium and Thorium. Understanding the shell structure in this region and in particular the survival or not of the neutron shell closures N=152 and N=162 is of particular importance in order to understand the mechanism responsible for the “actinide boost” observed in the U and Th elemental abundances of some metal-poor stars.

A special phenomenon relevant in astrophysical environments is the influence of free electrons in the plasma on reactions and decays. Decay lifetimes can be altered not only by thermal excitation of a nucleus, but also electron captures will depend on the electron density surrounding the nucleus. In reactions, nuclear charges are screened by the electron cloud. This is fundamentally different from screening in atoms or molecules. Nevertheless, these latter types of screening have to be understood as well, because they have an impact on precision measurements of low-energy cross sections of light targets, e.g., for hydrostatic burning. Screening in the plasma can be treated in the weak and strong screening approximations but more accurate treatments for intermediate or dynamic screening and the dependence on the plasma composition have to be developed. This is important not just for nucleosynthesis but also for the SNIa explosion mechanism.

Explosive nucleosynthesis calculations require the development of huge nucleosynthesis networks. In the particular case of r-process nucleosynthesis they comprise around 6000 nuclear species on the neutron-rich side and several 100,000 reactions if fission is included. On the proton-rich side, p-, rp- and vp-process nucleosynthesis also require networks extending far into the unstable region (up to  $A \approx 100$  all the way to the dripline) and including 10,000s of reactions. A simultaneous solution of the changes in hydrodynamical properties and composition represents a very challenging problem. Fortunately, in many scenarios reduced nuclear networks can be used to account for the energy generation while the detailed changes in composition can be described in a post processing approach.

---

Currently, all stellar models studying nucleosynthesis are 1-D. Multi-dimensional effects such as convection or the impact of rotation are implemented phenomenologically. Nevertheless, coupling full reaction networks to these calculations is already computationally expensive and often reduced networks combined with postprocessing are used. Future improved models and advanced computing will lead to more detailed astrophysical predictions requiring more accurate nuclear input. Concerning ccSN, it has been shown that a multi-D treatment is essential for obtaining an explosion and to describe the inner, turbulent layers of the exploding star. Due to the computationally expensive, but necessary, treatment of neutrino transport, large networks still cannot be coupled to the hydrodynamics even for the 1-D cases.

For Nova and X-ray Bursts the most accurate knowledge of the nucleosynthesis accompanying such cataclysmic events relies on hydrodynamic models in spherical symmetry (1-D). This includes the state-of-the-art codes KEPLER (Santa Cruz), NOVA (Arizona), SHIVA (Barcelona), AGILE (Basel), and the stellar evolution code from Tel Aviv (Israel). The first successful multidimensional calculations of nova outbursts have recently been performed. These include 2-D simulations with the codes VULCAN (Tel Aviv), PROMETHEUS (Garching), and FLASH (Chicago, Barcelona), although because of computational limitations, only simplified networks to handle approximately the energetics of the explosion are used. Moreover, the multidimensional nova simulations performed have been limited to about 1000 s around the peak of the explosion (while the overall phenomenon lasts for 100,000 yr, from the onset of accretion). Hence, the adopted strategy requires mapping of 1-D models into 2-D. In contrast, no realistic multidimensional calculation of type I XRBs has been performed to date.

Successful multidimensional nova simulations, intended to check whether Kelvin-Helmholtz instabilities can naturally lead to self-enrichment of the solar-like accreted envelopes with material from the outermost layers of the underlying white dwarf core, at levels in agreement with observations, would require 3-D calculations, since the way in which turbulence develops is completely different in 3-D than in 2-D. Arbitrarily Lagrangian-Eulerian (ALE) schemes, like that implanted in the VULCAN code, seem the best way to tackle the nature of such explosions. Moreover, implicit, parallelized hydro codes seem to be better suited to describe the complete nuclear history of XRBs and nova explosions, all the way from the onset of the early hydrostatic stages through a full cycle. It is likely that the continuous improvement in computational capabilities will allow the use of more extended nucleosynthesis networks directly coupled to the multidimensional hydro codes.

## 4.4.4 Conclusions

### Future science developments

The pace and direction of development of the field will depend on many things, making prediction difficult. In part this arises because of the highly interdisciplinary nature of the research, since advances in astronomical observations, new satellite capabilities, advances in astrophysical modelling etc. can produce new insights and new needs for nuclear physics information. In part it is the technological challenges of developing new radioactive beams or neutron and photon capabilities, new experimental techniques and new theoretical understanding. That said, certain topics seem certain to be at the forefront of the evolution of the field over the next decade and these are summarised below.

In terms of the nucleosynthesis classes, the situation is as follows.

**Big Bang nucleosynthesis:** The nuclear physics aspects in this area are mostly understood with the remaining uncertainty related to the lithium problem, which will hopefully be clarified within the next few years.

**Stellar nucleosynthesis:** Although much work has been done in the study of the nuclear reactions in the early stages of a star's life, our understanding is still plagued by numerous critical gaps in our knowledge. Detailed measurements are still needed on some key reactions (e.g.  $^{12}\text{C}(\alpha,\gamma)^{16}\text{O}$ ) and will need continuing work with direct and indirect methods at stable beam facilities over the next five years. By contrast our understanding of the advanced stages of burning is at a rudimentary stage and will require much work on stable and radioactive beam facilities over the next decade. Work also still remains to be done on the s-process, both in terms of the neutron capture rates themselves and the key reactions which are believed to provide the source of neutrons. Our ability to determine reaction rates is still at times bedevilled by a lack of accuracy in our reaction model calculations, and theoretical work on this is required.

**Explosive nucleosynthesis:** Our ability to describe these processes in a quantitative way is limited and much work is still needed which will require new radioactive beam facilities and new experimental techniques to be developed. This is unlikely to be completed in the next decade, but major advances can be expected. Our current understanding of the reaction networks in X-ray Bursters is based on modelling which, to a large extent, relies on reaction rate estimates from theoretical models. There will be increasing refinement of these models, cross checked by direct (or indirect) measurements of key reactions. This will be linked to increasingly testing observational data coming from a wide range of new

## 4.4 Nuclear Astrophysics

---

space- and ground-based astronomy instruments. In parallel with the experimental and observational work, theoretical advances are urgently needed on the reaction sequences in Supernovae, both in the core region as the collapse occurs and in the outer shells where the outgoing shock creates novel new nucleosynthesis networks (these comments apply equally to ccSN and SN1a). Charged particle, photon, neutron and neutrino induced reactions need to be understood and measured. The next generation of radioactive beam facilities will at last give us experimental access to the nuclei involved in the r-process and enable us to measure these reaction rates.

**Nuclear Physics in Compact Objects:** Neutron stars are unique cosmic laboratories for finding answers to one of the most fundamental questions of physics: what are the ultimate constituents of matter? Advances will be linked to increasingly sophisticated measurements coming from major new astrophysical instruments in which European scientists are involved. The intensification of ground-based and space-based observations as well as the exciting prospect of detecting gravitational waves drives the need for a better theoretical description of these peculiar objects. At present the main activity in this area is the development of the astrophysical models and these are beginning to be linked to realistic microscopic inputs. Much theoretical development in nuclear physics is thus required over the next five years in order to improve our understanding of dense matter properties. Experimental measurements to check these are rudimentary at present and the development of activity in this area can be expected to grow in the later part of the decade as the experimental facilities required are developed.

### Future facility developments

As a result of investment over the last decade, we are entering an exciting period for nuclear astrophysics experiments. Because of the wide range of different beam species required, and the wide range of energies, scientists require access to a wide variety of different accelerator facilities. Because of the low cross sections of some key reactions, the experiments often require very long measuring periods, and thus cannot be run at the large international laboratories where the pressure on beamtime is high. Instead, smaller, and often dedicated, facilities are better suited to address these measurements. Over the last decade, careful coordination by NuPECC and through the activities of the Integrating Activities funded by the EC in FP6 and FP7, a complementary network of stable beam facilities has been developed across Europe which will provide the highly required access. In addition, several AMS laboratories of different size are available in Europe which can per-

form complementary measurements of reactions with long-lived radionuclide end products. That said, continuing investment in these facilities will be required to improve the beam range and intensity, and to provide more sophisticated experimental setups to probe key reactions where the yields are low or the backgrounds high.

In addition to the stable beam facilities, construction of the next generation of radioactive beam facilities are now underway – fragmentation beams at FAIR and ISOL beams at SPIRAL-2, HIE-ISOLDE and SPES. These new beams will revolutionise our capability and allow a concerted attempt to understand nucleosynthesis in explosive sites where the evolution is dominated by reactions between unstable nuclei. The timely completion of these projects is vital to allow the exciting range of nuclear astrophysics experiments outlined above to begin. This next generation of facilities will enable great advances during the next decade, but beyond that the higher intensity, wider beam reach of EURISOL will be required. As this EURISOL project develops it is essential that the nuclear astrophysics community remain fully engaged in the project to ensure that the technical specifications of the facility remain in line with what is needed for this field.

Europe has held a leading position in terms of photo-nuclear reaction studies, but as the interest in this area grows, there is a demand for higher intensity and better quality beams. There is a strong case for considering the provision of a Laser Compton Backscatter facility and recent developments on the development of a nuclear physics programme associated with the ELI project offer such a possibility.

Europe has to date been well provided for in terms of neutron beams for neutron capture studies, with a number of active facilities and the recently upgraded n-TOF facility at CERN. However as interest grows in the nucleosynthesis in explosive environments like ccSN, and in the nuclear physics dominating the structure of neutron stars, there is a need for a new generation of such facilities with greatly increased neutron fluxes and better TOF measuring capability. Associated to these studies is a need for facilities capable of producing the quantities of radioactive nuclei required to fabricate targets.

For novae, efforts should focus on multidimensional models to account for the physical mechanism responsible for mixing at the core-envelope interface, taking advantage of the use of massive parallel supercomputers. This should be supplemented with some key observations intended to identify the predicted  $\gamma$ -ray signatures accompanying the explosion as well as systematic studies of the spectra (dust formation, complete



---

determination of abundance patterns, etc.). Dedicated efforts aimed at the identification of presolar nova oxide and SiC grains should be encouraged.

For X-ray bursts, it is critical to assess whether some mass ejection may result from late radiation-driven winds. Additional theoretical work is needed to determine the likely nucleosynthesis endpoint in these sources. Challenging high-resolution spectroscopy should be pursued to solve the existing controversy associated with the potential identification of absorption lines, as a way to constrain nucleosynthesis.

The contribution of Big Bang to the abundance pattern is rather well known. The remaining uncertainties, such as the  ${}^7\text{Li}$  problem, will require a multidisciplinary approach, including theoretical work on the contribution of non-thermal processes (cosmic ray spallation reactions) and of additional astrophysical sources (classical novae, type II supernovae) to the synthesis of  ${}^7\text{Be}$  ( ${}^7\text{Li}$ ), and key observations of lithium in extremely metal poor stars of the Galactic halo.

The important role of low- and intermediate-mass stars in element synthesis (s-process) would require improvement of the theoretical models (most likely in a multidimensional framework), in areas such as convective and non-convective (magnetically driven) mixing and dredge-up, tightly connected with the formation of the required  ${}^{13}\text{C}$  pocket, mass loss and rotation. This will benefit from high-resolution spectroscopic studies of intermediate-mass stars in different stages (from Main Sequence to the AGB phase) and in different environments, both in our Galaxy (halo, globular clusters...) and extragalactic.

For supernovae, theoretical efforts should focus on the determination of the burning flame regime and the likely transition from deflagration to detonation in type Ia models, and on the mechanism that drives the explosion (spherical or asymmetric) in type II models, including a better characterization of the neutrino transport. Multidimensional models are certainly required to address such issues, combined with high-resolution spectroscopy and panchromatic observations (X-ray,  $\gamma$ -rays...) to address other key features, such as the possible metallicity dependence of SNIa and its link with the cosmological applications of thermonuclear supernovae. Studies of laboratory X-grains condensed in the ejecta from (type II) supernovae can also play an important role in this field, and a tight connection with the cosmochemistry community will be required.

Much theoretical effort will be required to address some of the fundamental questions that remain to be solved for neutron stars, in areas such as the equation of the state, and a number of exotic properties such as

superfluidity. This work would benefit from high-resolution spectroscopic analyses of absorption atomic lines that may help to derive the M-R relationship and, in turn, put constraints on the predicted strange quark stars. Combined observational and theoretical studies of the cooling of neutron stars will aid a better understanding of the nature of the neutron star interior.

## Priorities

1. Nuclear astrophysics, perhaps uniquely, requires access to an extremely wide range of stable and radioactive beams and often involves very long periods of beamtime. It is vital to maintain and enhance the existing network of complementary facilities that have been developed through past coordinated efforts in Europe, from the small university based to the large national laboratory based, to satisfy the increasing demand for these beams and to provide the essential time for instrument development and student training. This is the priority for the period through to 2015 and beyond.
2. Along with the nuclear structure community (WG3) the nuclear astrophysics community is eagerly awaiting the completion of the next generation of radioactive beam facilities (FAIR, SPIRAL 2, HIE\_ISOLDE and SPES) which will provide a rich variety of complementary beams needed to tackle more complex issues. This work will become important during the period 2015-2020. The later three facilities are the precursor to EURISOL, which will be developed in the following decade.
3. During the period 2010-2015 it will be essential to select and construct the next generation of underground accelerator facility. Europe was a pioneer in this field, but risks a loss of leadership to new initiatives in the USA. Providing an underground multi-MV accelerator facility is a high priority. There are a number of proposals being developed in Europe and it is vital that construction of one or more facilities starts as soon as possible.
4. The small reaction yields typical of the field mean that high beam currents and extremely sophisticated experimental approaches are required. Towards the end of the decade a high intensity facility as envisaged in the ECOS proposal will be required to enable the nuclear astrophysics community to pursue the more challenging reaction measurements that are at present out of experimental reach.
5. Efforts must be made to strengthen the coordination between the nuclear physicists, astrophysical modellers and astronomers engaged in the field. The recently approved EuroGENESIS EUROCORES pro-

## 4.4 Nuclear Astrophysics

---

gramme and the ATHENA network under the ENSAR IA in FP7 must provide leadership in this area.

6. Nuclear theory and astrophysical modeling rely heavily on computing capabilities, both shared memory supercomputing and large cluster distributed memory nodes. The provision of such facilities is essential to progress as is the personnel to develop the theory and codes. Dedicated interdisciplinary positions need to be created at the interface between nuclear physics and astrophysics to ensure that this development can occur.

## 4. Scientific Themes

---

### 4.5 Fundamental Interactions

**Convener:** Nathal Severijns (Leuven)

Roberto Calabrese (Ferrara),  
Guido Drexlin (Karlsruhe),  
Dezső Horváth (Budapest),  
Klaus Kirch (Villigen),  
Krzysztof Pachucki (Warsaw),  
Fabrice Piquemal (Bordeaux),  
Stefan Schönert (Heidelberg),  
Rob Timmermans (Groningen),  
Cristina Volpe (Orsay),  
Christian Weinheimer (Münster),  
Oliver Zimmer (Grenoble)

**NuPECC Steering Committee Member:**  
Eberhard Widmann

**NuPECC Liaison:**  
Klaus Jungmann

## 4.5 Fundamental Interactions

### 4.5.1 Introduction

Symmetries play an important and crucial role in physics. Global symmetries give rise to conservation laws and local symmetries yield forces. Four fundamental interactions are known to date, i.e. gravitation, the weak interaction, electromagnetism, and the strong interaction. The Standard Model (SM) provides a theoretical framework in which electromagnetism and the weak interaction (which are unified into the electroweak interaction) and many aspects of the strong interactions can be described to astounding precision in a single coherent picture. It has three generations of fundamental fermions which fall into two groups, leptons and quarks. The latter are the building blocks of hadrons and in particular of baryons, e.g. protons and neutrons, which contain three quarks. Forces are mediated by bosons: the photon, the  $W^-$  and  $Z^0$ -bosons, and eight gluons.

The SM is found to describe observations hitherto very well, and as far as we know, the Standard Model is valid up to the Grand Unification Theory (GUT) energy scale,  $\sim 10^{16}$  GeV. Still, it has some theoretical difficulties. The electroweak and colour interactions are deduced from local  $U(1) \otimes SU(2) \otimes SU(3)$  gauge invariance requirements, and in order to make them work one has to introduce a spontaneously symmetry-breaking Higgs-field. Gravity does not fit into this picture. We do not know why there are exactly three fermion families, nor what causes the mixing of neutrino types. The presence of dark matter and the prevalence of matter against antimatter in the Universe, which might be related to CP violation, are also unexplained. There are extensions of the Standard Model trying to explain these effects, but so far we have no experimental evidence supporting any of them in spite of great efforts in particle and astroparticle physics.

One of the great actual challenges in physics therefore is the search for new phenomena, beyond the SM, pointing to a more general unified quantum field theory which provides a description of all four fundamental forces. The existence of phenomena such as neutrino oscillations, dark matter and the matter-antimatter asymmetry are three striking manifestations of physics beyond the SM.

Accurate calculations within the SM now provide a basis to searches for deviations from SM predictions. Such differences would reveal clear and undisputed signs of still other types of new physics and hints for the validity of speculative extensions to the SM. The variety of often speculative models beyond the present SM, that by no means can be discussed here, include e.g. left-right symmetry, fundamental fermion compositeness, new particles, leptoquarks, supersymmetry, supergravity and many more. Further, above the Planck energy scale

we may expect to have new physical laws which also allow for Lorentz and CPT violation. Interesting candidates for an all encompassing quantum field theory are string or membrane theories which in their low energy limit may include supersymmetry.

Experiments at nuclear physics facilities at low and intermediate energies offer in this respect a variety of possibilities which are complementary to approaches in high energy physics and in some cases exceed those significantly in their potential to steer physical model building.

To address open issues of the SM and search for physics beyond, theoretical and experimental activities in the field of fundamental interactions will concentrate in the next decade on the following key topics:

1. Fundamental symmetries
2. Neutrinos
3. Electroweak interactions

In doing so the following key questions will be addressed:

1. Which fundamental symmetries are conserved in nature?
2. What is the origin of the matter dominance in the universe?
3. Are there new sources of CP violation?
4. What are the properties of antimatter?
5. What are the properties of the neutrino?
6. Are there other than the four known fundamental forces?
7. Are there new particles and what is their role in the universe?
8. What are the precise values of the fundamental constants?

In order to investigate these key questions, the following key issues will be addressed:

- Fundamental fermions
  - Neutrino oscillations and the neutrino mixing matrix
  - Neutrino masses (direct measurements and double  $\beta$  decay experiments)
  - Quark mixing matrix and unitarity
  - New (time reversal invariant) interactions in nuclear  $\beta$  decays and neutron decay
- Discrete symmetries
  - Parity violation
  - Time reversal and CP violation in the quark sector (e.g. electric dipole moments)
  - CPT and Lorentz invariance
- Properties of known basic interactions
  - QED and fundamental constants (e.g.  $g-2$ , fine structure constant, H-like ions, anti-hydrogen ...)
  - QCD (exotic atoms)
  - Gravity (e.g. matter versus antimatter behaviour)



This could be achieved at upgraded present facilities and novel facilities yet to be built.

Note that the above questions are dealt with globally, in particular also in the USA and Japan. Fundamental Symmetries are one of the four key topics recently put forward by the NSAC Long Range Plan. New facilities are being set up and planned at e.g. Michigan, TRIUMF, RIKEN and JPARC and these labs are setting up new groups and taking new initiatives for fundamental interactions research. In general this field relies on precision measurements which requires long beam times and high particle intensities. But once completed every single experiment gets visibility and has large impact.

## 4.5.2 Fundamental Fermions

### Neutrino oscillations and the neutrino mixing matrix

A major advance in our knowledge of neutrino properties has been made in the last decade after the discovery of the neutrino oscillation phenomenon by the Super-Kamiokande experiment in 1998, with an impact in various fields of physics. Among the numerous implications are the fact that neutrinos are massive particles, contrary to what was believed for decades; in addition, the longstanding problems of the atmospheric anomaly and of the solar neutrino deficit have now been solved.

At present the two independent  $\Delta m^2$  as well as two out of the three mixing angles have been measured.

However, in spite of the impressive progress made in our knowledge of neutrino properties, crucial open questions remain. The main goal of future oscillation experiments will be to address these key open issues and to determine the value of the third neutrino mixing angle  $\theta_{13}$ , the sign of the atmospheric  $\Delta m^2_{23}$  and the value of the Dirac phase.

Neutrino oscillations turn out to be essential when neutrinos propagate in astrophysical environments, e.g. in core-collapse supernovae, in accretion-disks around black holes, as well as in the early Universe just before Big-Bang nucleosynthesis. Concerning the solar neutrino measurements, at present the BOREXINO experiment is running and has given confirmation of the Large Mixing Angle solution, of the solar neutrino deficit problem, with both  ${}^7\text{Be}$  and  ${}^8\text{B}$  neutrinos.

As far as the third mixing angle is concerned, only an upper limit is available. In the near future three reactor experiments – Double-Chooz, RENO and Daya Bay – and the first super-beams experiments (T2K and NOvA) will be able to measure its value if  $\sin^2 2\theta_{13} < 0.02$ . Note that the combination of the available experimental data indicates that the value of  $\theta_{13}$  might actually be close to the present limit.

One of the major important open issues is the possible existence of CP violation in the lepton sector. A non-zero Dirac phase introduces a difference between neutrino and anti-neutrino oscillations. Such an observation would have an enormous impact in various domains of physics, from high-energy physics to cosmology. In particular, it would bring an important element to our understanding of matter versus anti-matter asymmetry in the Universe.

### Neutrino oscillations and the neutrino mixing matrix

Theoretically the observation of the neutrino oscillations implies that the neutrino interaction (or flavour  $\alpha$ ) basis is related to the propagation (or mass  $i$ ) basis through a unitary matrix called the Maki-Nakagawa-Sakata-Pontecorvo (MNSP) matrix (Figure 1), the analogue of the Cabibbo-Kobayashi-Maskawa (CKM) matrix in the quark sector. In recent years the goal of solar, atmospheric, accelerator and reactor experiments has been to precisely measure the oscillation parameters. These comprise the difference of the neutrino mass eigenstates  $\Delta m_{ij}^2 = |m_i^2 - m_j^2|$  and the elements of the MNSP matrix  $U_{\alpha i}$ . If three active neutrino families are considered such a matrix depends on three mixing angles and three CP violating phases, one Dirac and two Majorana phases. The last ones have physical meaning only if neutrinos are Majorana particles, identical to their antiparticles. Then these phases influence neutrinoless double beta decay and other processes. However, they do not affect neutrino oscillation, regardless of whether neutrinos are Majorana particles.

$$U = \begin{pmatrix} 1 & 0 & 0 \\ 0 & \cos\theta_{23} & \sin\theta_{23} \\ 0 & -\sin\theta_{23} & \cos\theta_{23} \end{pmatrix} \begin{pmatrix} \cos\theta_{13} & 0 & \sin\theta_{13}e^{-i\delta} \\ 0 & 1 & 0 \\ -\sin\theta_{13}e^{-i\delta} & 0 & \cos\theta_{13} \end{pmatrix} \begin{pmatrix} \cos\theta_{12} & \sin\theta_{12} & 0 \\ -\sin\theta_{12} & \cos\theta_{12} & 0 \\ 0 & 0 & 1 \end{pmatrix}$$

Figure 1. The neutrino mixing matrix with the three mixing angles between the different neutrino generations and the CP violating Dirac phase  $\delta$ .

## 4.5 Fundamental Interactions

The CP violation search will require neutrino beams with the highest possible intensities, tiny intrinsic backgrounds and very good control of systematic errors. The goal of long term oscillation experiments is to address leptonic CP violation, the neutrino hierarchy and small values of the third neutrino mixing angle. Three possibilities can be envisaged: super-beams, beta-beams and neutrino factories. Super-beams are neutrino beams coming from conventional sources (pion and muon decays) pushed to their ultimate intensity. Neutrino factories are based on the production, acceleration and storage of muons to obtain intense muon and electron (anti)neutrino beams.

The beta-beam concept, proposed by Zucchelli, is a new method for the production of intense neutrino beams based on the  $\beta$  decay of boosted radioactive ions. Such beams are pure in flavour (only  $\nu_e$  or  $\bar{\nu}_e$  depending on the  $\beta$  decaying ion) and have well known fluxes. In the original scenario the beta-beam baseline is hosted at CERN. The ions are produced through the ISOL technique and stored in a storage ring. When they decay, they produce a neutrino beam pointed to a far large-size detector located in an enlarged Frejus Underground Laboratory to compare  $\nu_e \rightarrow \nu_\mu$  with  $\bar{\nu}_e \rightarrow \bar{\nu}_\mu$ . The megaton size Cherenkov detector (about 20 times Super-Kamiokande) would be a multipurpose detector for the search of CP violation and proton decay, as well as the observation of (relic) supernova neutrinos. The  $(3\sigma)$  discovery limit for  $\sin^2 2\theta_{13} > 3 \times 10^{-4}$  covers a large fraction of all  $\delta$  values making the beta-beam option a very competitive strategy. As far as the hierarchy is concerned, the neutrino factory can identify the mass hierarchy through matter effects, while the beta-beam can use a combination with atmospheric data in the same detector if the third neutrino angle is large.

Note that a low energy beta-beam facility has also been proposed with the purpose of performing neutrino interaction measurements of interest for nuclear physics, for the study of fundamental interactions and for core-collapse supernova physics. A feasibility study of the original beta-beam baseline has been performed within the EURISOL Design Study (FP6, 2005-2009). Clearly a key issue is to reach the required ion intensities. Further investigation on high ion production techniques for the isotopes of interest is crucial.

As far as a comparison among the facilities is concerned, if  $\sin^2 2\theta_{13} > 0.02$  (large) the superbeam, beta-beam and neutrino factory have similar sensitivity to the Dirac phase. For values of  $5 \times 10^{-4} < \sin^2 2\theta_{13} < 0.02$  the superbeams are outperformed by the beta-beam and the neutrino factory. Only the optimised neutrino factory can reach values of  $\sin^2 2\theta_{13}$  smaller than  $5 \times 10^{-4}$ , while the optimised beta-beam and the conservative neutrino factory option have a comparable performance.

### Neutrino masses

Neutrino oscillation experiments have provided clear evidence for the neutrinos to be massive particles. However, the fact that they turn out to be lighter by at least 6 orders of magnitude than any charged fermion is difficult to ascribe simply to much smaller Yukawa couplings to the Higgs. It is therefore much more reasonable to assume that neutrino masses are based on so-called Majorana mass terms, which are only allowed for the neutral neutrinos. The seesaw mechanism would be a natural explanation for the smallness of neutrino masses, but it would require new physics beyond the Standard Model. Determining the neutrino masses would allow a distinction to be made between different theories.

Unfortunately, neutrino oscillation experiments provide us with the differences of the squared neutrino masses  $\Delta m_{ij}^2$  and cannot determine the sign of  $\Delta m_{ij}^2$  nor the absolute neutrino masses. Still, once one neutrino mass has been determined by different means, the other neutrino masses could be reconstructed using the values from neutrino oscillation experiments. The absolute neutrino mass has strong consequences for astrophysics and cosmology as well as for nuclear and particle physics.

Therefore, an absolute determination of one neutrino mass is one of the most important next steps in neutrino physics. In cosmology an upper limit of  $\sum m_i < 0.61$  eV/c<sup>2</sup> on the sum of the three neutrino masses has been obtained from the size of fluctuations in the microwave background at small scales. This is, however, to some extent model- and analysis-dependent. It is expected that the data from the recently launched PLANCK satellite will allow improvement to the sensitivity of the neutrino mass to the 100 meV/c<sup>2</sup> range within the next decade.

Other approaches are direct mass measurements and searches for neutrinoless double  $\beta$  decay ( $0\nu\beta\beta$ ).

### Direct mass measurements

Direct neutrino mass determination is based on the investigation of the kinematics of weak decays, the signature of a non-zero neutrino mass being a tiny modification of the spectrum of the  $\beta$  electrons near its endpoint. This allows determination of the “average electron neutrino mass”  $m(\nu_e)^2 := \sum |U_{ei}|^2 m(\nu_i)^2$  with this incoherent sum not being sensitive to phases of the neutrino mixing matrix. For optimal sensitivity  $\beta$  emitters with low endpoint energy are favoured. Two different isotopes, tritium (<sup>3</sup>H) and <sup>187</sup>Re, are suited for these experiments. Tritium (with an endpoint energy of 18.6 keV and a half-life of 12.3 y)  $\beta$  decay experiments have been performed in the search for the neutrino mass for more than 50 years, yielding a sensitivity of 2 eV/c<sup>2</sup> by the experiments at Mainz and Troitsk. The KATRIN

experiment that is currently being set up at the Karlsruhe Institute of Technology is a further development of these experiments. The concept is based on a very strong windowless gaseous tritium source to reduce the systematic uncertainties and on a high-luminosity and high-resolution electrostatic spectrometer of MAC-E-Filter type resulting in a sensitivity on the neutrino mass of 200 meV/c<sup>2</sup>. This aimed improvement of two orders of magnitude in the  $m(\nu_e)^2$  is connected to the requirement of new developments and severe challenges of controlling the tritium source pressure and temperature at the per mille level, of providing extreme vacuum conditions of about 10<sup>-11</sup> mbar, of developing new background reducing methods and of controlling the retarding high voltage at the ppm level. The  $\beta$  spectrum of 10<sup>11</sup> decays per second has to be measured with an energy resolution of less than 1 eV at a background level of 0.01 events per second. This also requires the <sup>3</sup>He/<sup>3</sup>H mass ratio to be determined with high precision using Penning trap based mass spectrometry. The KATRIN experiment will start taking data in 2012 and requires three years of full data taking within 2012–2018 to reach its design sensitivity.

As to the second isotope, i.e. <sup>187</sup>Re, the advantage of the lower endpoint energy of 2.47 keV can only be exploited if the entire released energy, except that of the neutrino, is measured in view of its long half-life of 4.3 x 10<sup>10</sup> y and the complicated electronic structure. This can be realised by using a cryogenic bolometer as the  $\beta$  spectrometer, which at the same time contains the  $\beta$  emitter. This was pioneered at Milan and Genoa with proof of principle experiments that yielded limits on the neutrino mass of 15 eV/c<sup>2</sup> and 26 eV/c<sup>2</sup>. To further increase significantly the sensitivity three improvements have to be achieved: much better energy resolution in the eV range, time constants in the  $\mu$ s range and large arrays of many thousands of detectors. The former Milan and MANU groups are working together with new groups, forming the MARE collaboration, to improve the sensitivity in two steps, down to a few eV/c<sup>2</sup> and to a few hundred meV/c<sup>2</sup>.

The results from neutrino oscillation experiments show that the “average electron neutrino mass” can be as small as 50 meV/c<sup>2</sup> (inverted hierarchy) or even as small as about 10 meV/c<sup>2</sup> (normal hierarchy). For the cryo-bolometer technique there is no principle limitation in size to reach even higher sensitivities, in contrast to the KATRIN technique with its 70 m overall length and 10 m diameter main spectrometer. On the other hand, a sensitivity on the neutrino mass of 200 meV/c<sup>2</sup> requires an improvement of four orders of magnitude in the observable  $m(\nu_e)^2$ , which is by far a non-trivial challenge. Therefore, other possibilities, also with tritium, have to be considered to achieve a sensitivity in the 10

meV/c<sup>2</sup> range. Some initial ideas of alternative ways to directly measure the neutrino mass are being discussed in the community.

## Neutrinoless double $\beta$ decay

Establishing whether neutrinos are Dirac fermions (different from their antiparticle) or Majorana fermions (spin 1/2 particles identical to their antiparticles) is of paramount importance for understanding the underlying symmetries of particle interactions and the origin of neutrino masses. The only practical way to test whether neutrinos are Majorana particles is to search for neutrinoless double  $\beta$  decay (0 $\nu\beta\beta$ ).

The neutrinoless double  $\beta$  decay of a nucleus consists of the simultaneous transition of two neutrons into two protons with the emission of two electrons. This process is forbidden in the Standard Model. The experimental signature of this decay is a peak in the distribution of the electron sum energy at the transition energy. Precision measurements of the Q-values for double beta decay isotopes with Penning trap setups allow an accurate fix of the peak position.

There are several possible mechanisms leading to the 0 $\nu\beta\beta$  process: exchange of a light neutrino, right-handed weak currents, exchange of super-symmetric particles, and other non-standard interactions. Independent of the leading term, the observation of 0 $\nu\beta\beta$  decay would unambiguously establish the Majorana nature of neutrinos. Once the 0 $\nu\beta\beta$  decay has been observed experimentally, the nature of the leading term could be studied by measuring the energy and angular distribution of the single electrons, by measuring the branching ratios of 0 $\nu\beta\beta$  decays to excited levels, and by comparison of the decay rates of different nuclei.

In the case of light neutrino exchange, the half-life of the 0 $\nu\beta\beta$  decay depends on the effective Majorana neutrino mass ( $m_{ee}$ ) as  $(T_{1/2}^{0\nu})^{-1} = G^{0\nu} |M^{0\nu}| \langle m_{ee} \rangle^2$ , where  $G^{0\nu}$  is a calculable phase space factor,  $M^{0\nu}$  is the nuclear matrix element of the process, and  $\langle m_{ee} \rangle = |U_{e1}^2| m_1 + |U_{e2}^2| m_2 e^{i\phi_1} + |U_{e3}^2| m_3 e^{i\phi_2}$  is the effective Majorana neutrino mass, with  $m_1, m_2, m_3$  the masses related to the three neutrino mass eigenstates,  $U_{e1}, U_{e2}, U_{e3}$  the elements of the first row of the neutrino mixing matrix and  $\phi_1, \phi_2$  the Majorana CP phases ( $\pm 1$  if CP is conserved). Figure 2 shows the range of  $\langle m_{ee} \rangle$  as predicted by neutrino oscillation experiments for a normal, inverted and quasi degenerate neutrino mass scheme.

The present experimental sensitivity corresponds to the quasi degenerate mass scheme ( $m_1 \approx m_2 \approx m_3$ ) and one experiment claims the observation of 0 $\nu\beta\beta$  decays of <sup>76</sup>Ge.

## 4.5 Fundamental Interactions

The next generation of experiments (cf. Table 1) will test this claim and will explore part of the mass range predicted by oscillation experiments for the inverted hierarchy ( $\Delta m_{23}^2 < 0$ ). These experiments will also serve as bench tests for the following one ton scale experiments which are required to explore completely the inverted mass hierarchy. The meV mass range, predicted in the case of the normal hierarchy ( $\Delta m_{23}^2 > 0$ ), is beyond the reach of current technologies.

Two main experimental approaches are pursued: calorimeters measure the sum energy of the two electrons while tracking calorimeters or TPCs record the kinematics of the single electrons. In one experimental approach, it is planned to identify the daughter nucleus as an additional method to discriminate background events. Different experimental approaches are required in order to reduce possible systematic uncertainties as well as experiment-specific backgrounds.

The enrichment of isotopes is crucial for double  $\beta$  decay experiments. Presently, all isotopes have been enriched by the centrifugation method in Russia. However, some isotopes, in particular  $^{48}\text{Ca}$  and  $^{150}\text{Nd}$  which are favourable from the point of view of transition energy and phase space factor, cannot be enriched by centrifugation. A European facility to provide double  $\beta$  decay isotopes at the hundred kilogram scale based on an ion cyclotron resonance separation method would be desirable. Such a facility would be able to enrich almost all interesting double  $\beta$  decay emitters. Related to the enrichment, physical or chemical purification methods are also needed.

Important progress has been made for the Nuclear Matrix Element calculations over recent years. Nonetheless, the development of these calculations should be strongly supported in the future in order to

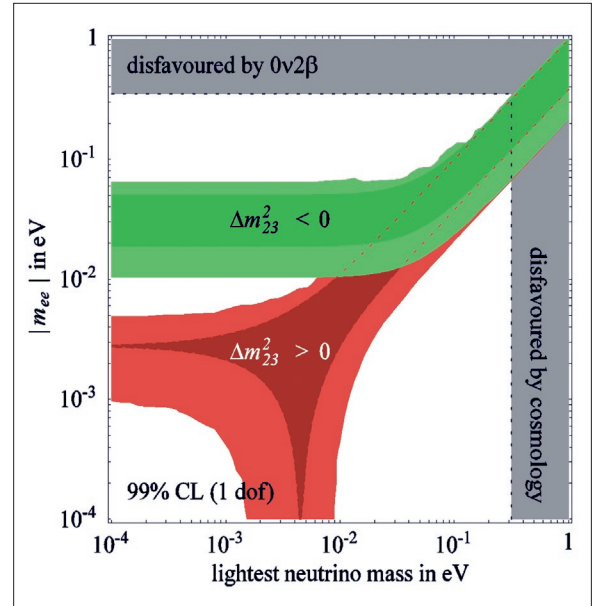

**Figure 1.** The effective neutrino mass ( $m_{ee}$ ) as a function of the lightest neutrino mass shown for the normal (i.e.  $\Delta m_{23}^2 < 0$ ), inverted ( $\Delta m_{23}^2 > 0$ ) and quasi degenerate neutrino mass scheme as predicted by neutrino oscillation experiments. The different lines and colours correspond to various assumptions on CP violating phases. Limits from neutrinoless double  $\beta$  decay experiments and constraints from cosmology are displayed.

provide guidance in the choice of double  $\beta$  decay isotopes and to extract the effective neutrino mass from the measured lifetime. Auxiliary experiments in support of the nuclear structure calculations as charge exchange reactions or muon capture should be carried out.

It is noteworthy that some of the detector materials used in neutrinoless double  $\beta$  decay, e.g. Ge and Xe,

| Name      | Nucleus                               | Mass*  | Method                | Location | Expected start date | Expected final sensitivity (eV) |           |
|-----------|---------------------------------------|--------|-----------------------|----------|---------------------|---------------------------------|-----------|
| CUORE     | $^{130}\text{Te}$                     | 200 kg | Bolometric            | LNGS     | EU                  | 2012                            | 0.05–0.10 |
| EXO-200   | $^{136}\text{Xe}$                     | 160 kg | Liquid TPC            | WIPP     | USA                 | 2010                            | 0.13–0.19 |
| GERDA     | $^{76}\text{Ge}$                      | 35 kg  | Ionization            | LNGS     | EU                  | 2010                            | 0.08–0.13 |
| LUCIFER   | $^{82}\text{Se}$                      | 18 kg  | Bolometric            | LNGS     | EU                  | 2014                            | 0.05–0.07 |
| MAJORANA  | $^{76}\text{Ge}$                      | 30 kg  | Ionization            | DUSL     | USA                 | 2013                            | 0.08–0.13 |
| NEXT      | $^{136}\text{Xe}$                     | 100 kg | Gas TPC               | LSC      | EU                  | 2013                            | u.e.      |
| SNO+      | $^{150}\text{Nd}$                     | 40 kg  | Scintillation         | SNOLab   | CAN                 | 2011                            | 0.1       |
| SuperNEMO | $^{82}\text{Se}$ or $^{150}\text{Nd}$ | 100 kg | Tracking, calorimetry | LSM      | EU                  | 2013                            | 0.04–0.15 |

**Table 1.** Overview of funded next-generation double  $\beta$  decay experiments and projects with substantial R&D grants. \*Mass of double  $\beta$  decay isotopes not including detection and analysis efficiencies which range from about 30% (e.g. SuperNEMO) to about 90% (e.g. GERDA, CUORE). The numbers given for 'expected final sensitivity' depend on the assumed background level, the expected duration of data taking and choice of nuclear matrix elements and are therefore only indicative values. TPC, time projection chamber; LNGS, Gran Sasso National Laboratory, Italy; WIPP, Waste Isolation Pilot Plant, USA; DUSL, Deep Underground Science Laboratory, USA; LSC, Laboratoire Subterranéo de Canfranc, Spain; SNOLab, Sudbury Neutrino Observatory, Canada; LSM, Laboratoire Souterrain de Modane, France. u.e., under evaluation. Not listed is the KamLAND experiment in Japan, which plans to load  $^{136}\text{Xe}$  in the liquid scintillator detector.



but also scintillating bolometers as well as experimental techniques are also employed in experiments searching for direct Dark Matter interactions. The latter experiments are optimised to achieve a high discrimination power between ionising and recoil events at a keV energy deposition. Close co-operation between the communities is recommended to resolve common experimental challenges.

## Quark mixing

Well before the observation of neutrino mixing it had been established that quarks participate in weak interactions with a mixture of their mass eigenstates. The mixing is governed by the Cabibbo-Kobayashi-Maskawa (CKM) matrix. In the past the unitarity of this matrix has been questioned by a series of experiments, but recent theoretical as well as experimental advances related to the dominant  $V_{ud}$  and  $V_{us}$  matrix elements have confirmed unitarity at the  $6 \times 10^{-4}$  level.

This was mainly due to a shift of the value of  $V_{us}$  by about 2.5 standard deviations from the previously adopted value, which has by now been confirmed by several independent measurements and is now firmly established. Further progress on  $V_{us}$  not only requires new and more precise branching ratio measurements in K-decays, but also that the theoretical uncertainties in calculating SU(3) symmetry breaking effects in the axial-vector couplings favouring K-decay experiments be reduced.

The value of the other matrix element of importance for the unitarity test of the first row of the CKM matrix, i.e.  $V_{ud}$ , can be obtained from nuclear decays, from free neutron decay and from pion decay, with the first one presently providing the highest precision. As to the value of  $V_{ud}$  obtained from the corrected Ft-values (i.e. the product of the partial half-life and the phase space factor for a  $\beta$  transition, corrected for nucleus-dependent radiative and nuclear structure corrections) for superallowed pure Fermi transitions, recently much progress was made both experimentally and theoretically: the precision and control over isospin symmetry breaking related nuclear structure effects,  $\delta_C$ , as well as the nucleus independent radiative correction,  $\Delta_R$ , has been significantly improved. On the experimental side several new isotopes have been added to the set of nuclei contributing to the determination of  $V_{ud}$ . Further, the use of Penning traps providing high precision mass values (i.e. ISOLTRAP, JYFLTRAP and SHIPTRAP in Europe and several similar setups in the US) has increased significantly the reliability as well as the precision of  $Q_{EC}$  values (i.e. the energy difference between the ground states of mother and daughter isotopes) for many of the relevant transitions. As a result the Conserved Vector

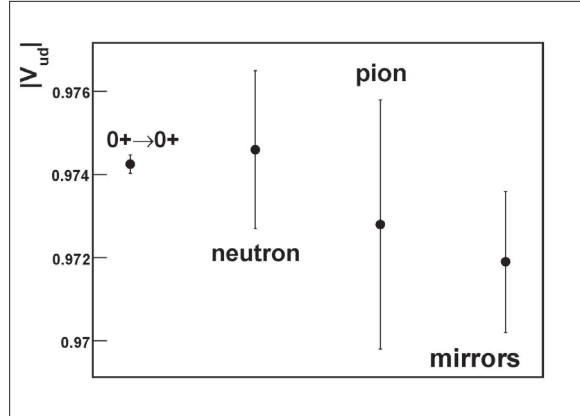

**Figure 2.** Values of  $|V_{ud}|$  from the  $0^+ \rightarrow 0^+$  super-allowed Fermi transitions, neutron decay, pion beta decay and the beta transitions of  $T=1/2$  mirror nuclei.

Current hypothesis is now validated at the level of  $1.3 \times 10^{-4}$  and  $|V_{ud}| = 0.97425(22)$ . Recent newly developed trap operation modes will yield further improvements for  $Q_{EC}$  values. Further progress also requires that Penning trap based mass measurements as well as high precision half-life and branching ratio measurements be performed for the recently added superallowed transitions, which will at the same time help to improve the theoretical calculations of the nuclear structure related corrections.

An independent, though at present less sensitive, test of CVC and CKM unitarity was recently provided by combining the newly reported corrected Ft-values for the superallowed  $\beta$  transitions between  $T = 1/2$  mirror nuclei with results from correlation measurements performed with these nuclei. It was shown that several of these mirror  $\beta$  transitions have the potential for providing a precision on  $V_{ud}$  that is competitive to the value from the pure Fermi transitions, the highest sensitivity being obtained for  $^{35}\text{Ar}$ . Measurements leading to more precise Ft-values as well as precise measurements of the  $\beta$  asymmetry parameter and  $\beta$ - $\nu$  correlation coefficient for mirror  $\beta$  transitions would therefore be of great value.

The neutron lifetime,  $\tau_n$ , and the  $\beta$  asymmetry parameter  $A_n$  or the beta-neutrino angular correlation coefficient  $a_n$  in neutron decay provide values of the axial-vector weak coupling constant of the nucleon,  $g_A$ . This not only serves for determining many important semi-leptonic weak cross sections, such as in stellar fusion, big-bang nucleosynthesis and for neutrino detection, but also allows one to extract a precise value for  $V_{ud}$ , independent of nuclear structure effects. Using the values for the neutron lifetime and  $\beta$  asymmetry parameter recommended by the Particle Data Group (2008) yields  $|V_{ud}| = 0.9746(19)$ , in agreement with but still less precise than the value

## 4.5 Fundamental Interactions

**Table 2.**  $\mu \rightarrow e$  conversion experiments (S = sensitivity to branching ratio)

| Project         | laboratory | status      | $E_p$ [GeV] | $p_m$ [MeV/c] | $\mu^-$ stops [ $s^{-1}$ ] | S                   |
|-----------------|------------|-------------|-------------|---------------|----------------------------|---------------------|
| SINDRUM II      | PSI        | finished    | 0.6         | $52 \pm 1$    | $10^7$                     | $2 \times 10^{-13}$ |
| mu2e            | FNAL       | under study | 8           | $45 \pm 25$   | $0.6 \times 10^{10}$       | $4 \times 10^{-17}$ |
| PRISM/<br>PRIME | J-PARC     | LOI         | 40          | $68 \pm 3$    | $10^{12}$                  | $5 \times 10^{-19}$ |

from the Fermi transitions. It is therefore of utmost importance that the problem of the difference between the two most precise results for the neutron lifetime of about 6 standard deviations be resolved, using new techniques of trapping ultracold neutrons at existing and upcoming European ultracold neutron facilities. In addition, new and independent measurements of  $A_n$  are required to confirm the recent results obtained with the PERKEO-II setup, that are more precise than, but also systematically differing from, results of previous experiments. This is most probably related to the significantly smaller corrections required for the PERKEO-II based measurements.  $A_n$  as well as other decay asymmetries such as the neutrino asymmetry  $B$  and the proton asymmetry  $C$  will be accessible under much improved experimental conditions at the planned PERC facility that will provide a brilliant and versatile source of decay electrons and protons for precision spectroscopy in combination with new or already existing neutron decay spectrometers such as aSPECT. Note that values of  $V_{ud}$  obtained from neutron and nuclear  $\beta$  decay are ultimately limited by the precision with which the nucleus independent radiative correction,  $\Delta_R$ , is known, as this affects all these decays in the same manner.

It is finally to be noted that a new and more precise value for  $V_{ud}$  from pion  $\beta$  decay was also obtained recently, i.e.  $|V_{ud}| = 0.9728(30)$ . Although being in agreement with the value from the pure Fermi transitions, the precision of this value is not yet competitive due to the very small branching ratio of  $\sim 10^{-8}$ .

With unitarity being established strong limits on several types of new physics, e.g. on right-handed charged weak currents and possible scalar contributions to the weak interaction, were obtained. Further improvements of the precision for the values of  $|V_{us}|$  and  $|V_{ud}|$  will further lower these upper limits or may ultimately uncover new physics beyond the Standard Model.

### Baryon and lepton number(s) violation

The threefold replication of the fundamental fermions and the quantitative patterns observed in the quark and lepton mixing matrices remain unexplained to date. A more fundamental theory is required to solve this puzzle and new phenomena at the high energy frontier and/or violations of conservation laws at low energy are needed to discriminate between the various options.

Family number is not conserved in electroweak interactions allowing decays such as  $b \rightarrow s\gamma$  and  $\mu \rightarrow e\gamma$  and neutrino oscillations. Family mixing as observed in neutrino oscillations does not imply measurable branching ratios for lepton flavour violation processes involving charged leptons. The rates are suppressed relative to the dominant family-number conserving modes by a factor  $(\delta m_\nu/m_W)^4$  which results in tiny branching ratios. Note that  $b \rightarrow s\gamma$  does obtain a very significant branching ratio of  $O(10^{-8})$  due to the large top mass.

In almost any extension to the Standard Model additional sources of lepton flavour violation appear. For each scenario a large number of model calculations can be found in the literature, with predictions that may well be accessible experimentally.

### Baryon number B and Lepton number L

In Grand Unified Theories quarks may turn into leptons and decays such as  $p \rightarrow \pi_0 e^+$  are allowed at some extremely low level. B and L are both violated but B-L is conserved. Even B-L would be violated when neutrinos are Majorana particles (requiring a  $\Delta L=2$  interaction) and/or baryon-antibaryon oscillations ( $\Delta B=2$ ) would be allowed. Parameter space is constrained mostly by limits on the proton lifetime and  $n \leftrightarrow \bar{n}$  oscillations.

### Lepton family numbers $L_i$

Charged lepton flavour violation processes, i.e. transitions between e,  $\mu$ , and  $\tau$ , might be found in the decay of almost any weakly decaying particle and upper limits exist from  $\mu$ ,  $\tau$ ,  $\pi$ , K, B, D, W and Z decay. Whereas

highest experimental sensitivities were reached in dedicated  $\mu$  and K experiments,  $\tau$  decay starts to become competitive.

### $L_1 \leftrightarrow L_2$

Whereas most models favour  $\mu^+ \rightarrow e^+ \gamma$  the experimental sensitivity is limited by accidental  $e^+ \gamma$  coincidences so available beam intensities cannot be fully exploited. Searches for  $\mu$ -e conversion, on the other hand, are limited by the beam intensities and large improvements in sensitivity may still be achieved.

The present  $\mu \rightarrow e^+ \gamma$  upper limit of  $1.2 \times 10^{-11}$  was established by MEGA at LAMPF. The new MEG experiment at PSI, which uses a novel liquid Xe scintillation calorimeter viewed by photomultipliers from all sides, aims at a single-event sensitivity of  $\sim 10^{-13}$ . Ten times larger surface muon rates than used by MEG can be achieved at PSI today already but the background suppression would have to be improved by two orders of magnitude.

The present best limits on  $\mu - e$  conversion have all been measured with the SINDRUM II spectrometer at PSI. New  $\mu - e$  conversion experiments using pulsed proton beams are currently being considered both at Fermilab in the USA and at J-PARC in Japan (see Table 2). Key improvements concern the muon momentum transmission and reduced pion induced background.

### $L_{1,2} \leftrightarrow L_3$

B-factories operating around the  $Y(4S)$  resonance also serve as  $\tau$  factories. The decay products of the tau pair produced are well separated in space thus offering the possibility to tag one of them by selecting a dominant decay mode for the other. Upper limits of  $O(10^{-8})$  have been reached for the branching ratios of the various channels. Similar upper limits will be achieved for the  $\tau \rightarrow 3\mu$  branching ratio at LHC during the low luminosity phase. Lepton flavour violating  $\tau$  decays are predicted in many extensions of the Standard Model with branching ratios partially next to the current experimental upper limit. Therefore, lepton flavour violating  $\tau$  decays are an interesting option in the search for new physics. Improved searches, with upper limits of  $O(10^{-10})$ , received high priority at the Super B-factories proposed in Italy and Japan.

Note, finally, that the decays of the lowest-lying pseudoscalar mesons also offer a wide variety of symmetry tests. Such tests are being pursued at the BEPC, COSY, ELSA, DAPHNE and MAMI facilities. It is expected that the number of  $\pi^0$ ,  $\eta$ ,  $\eta'$  and  $J/\psi$  decays detected will be multiplied in the upcoming years, leading to much improved limits or discoveries.

## New (time reversal invariant) interactions in nuclear and neutron $\beta$ decays

The Vector-Axial vector character of the weak interaction, discovered in experiments in nuclear  $\beta$  decay, seems well established. However, even though all experimental data agree with the V-A theory, other interactions could still participate at about the 5 to 10% level. In  $\beta$  decay new interactions can be probed by precision experiments which measure several types of correlation between the spins and momenta of the particles involved in the decay. Thus, the presence of exotic interactions (e.g. scalar S and tensor T) can be investigated, as well as the masses and couplings of the corresponding bosons that are related to such new interactions. Both neutron and nuclear decays are being studied. In the first case the precision is not affected by nuclear structure corrections. However, in nuclear  $\beta$  decay nature provides a large amount of nuclear states with different properties so that transitions can be selected to yield sensitivity to particular physics beyond the SM and at the same time ensure that nuclear structure related corrections are small or well under control. Note that reaching the required precision requires long beam times to collect the necessary statistics as well as to get good control of systematic errors. The experiments would therefore benefit significantly from dedicated facilities providing sufficient beam time, such as the ISOL@MYRRHA facility that is planned in Belgium.

The pseudoscalar contribution to  $\beta$  decay vanishes in the non-relativistic approximation for nuclei. A very stringent constraint ( $\sim 10^{-4}$  level) was obtained from the pion-decay branching ratio  $\Gamma(\pi \rightarrow e\nu)/\Gamma(\pi \rightarrow \mu\nu)$ . The new interactions can have time reversal (T) invariant and time reversal violating components. The latter will be discussed in section 4.5.3.

### New time reversal invariant vector and axial-vector interactions

Precision measurements of observables that are sensitive to right handed (V+A) interactions provide powerful means to probe specific scenarios of new physics beyond the SM in which the parity symmetry is restored at some level due to the exchange of non-standard new bosons. The most popular ones are the so-called left-right symmetric models, which allow for the presence of a W gauge boson that couples to right-handed particles.

Until recently, relative measurements in nuclear decays comparing the longitudinal polarisation of positrons emitted along two opposite directions with respect to the nuclear spin, provided the most stringent tests

## 4.5 Fundamental Interactions

of maximal parity violation in low energy  $\beta$  decay. The combination of the neutron lifetime,  $\tau_n$ , with the electron asymmetry,  $A_n$ , and the neutrino asymmetry,  $B_n$ , in neutron decay has now reached a comparable sensitivity. All measured quantities have reached a level of precision of a few parts in  $10^{-3}$  and all measurements so far are consistent with the SM predictions.

Within general left-right symmetric extensions of the SM, results obtained from low-energy  $\beta$  decays, from muon decay and from direct searches for new heavy charged bosons at colliders complement each other due to their different sensitivities to the parameters. Moreover, parity restoration mechanisms which involve quark-lepton interactions cannot directly be probed in the purely leptonic muon decay. In such a context any new effort at low energies to search for the effects of new bosons in the mass range between  $500 \text{ GeV}/c^2$  and  $1 \text{ TeV}/c^2$ , is highly valuable.

In neutron decay the most recent results for the  $\beta$  and neutrino asymmetries obtained with PERKEO-II feature several times smaller corrections than previous results and new measurements are being prepared (e.g. with the new PERC facility). Efforts are also ongoing and planned in the US, at LANSCE (Los Alamos), NIST and

the SNS (Oak Ridge). Solving the current issue of the neutron lifetime is therefore of crucial importance for establishing more stringent limits for new physics.

In nuclear  $\beta$  decay the precision of  $\beta$  asymmetry measurements is improving and a first measurement of the neutrino asymmetry has recently been made. In both cases still higher precision and more precise determination of the nuclear polarisation are highly desirable. As demonstrated earlier the use of atom and ion traps could contribute significantly to this as effects of scattering are strongly reduced.

This would then allow measurements of the longitudinal polarisation of positrons from polarized nuclei also to be made, which can be very sensitive to V+A interactions. For well chosen transitions sensitivities to right-handed bosons with a mass of about  $500 \text{ GeV}/c^2$  and beyond are feasible, but are presently hampered by scattering effects on insufficient nuclear polarisation. Further efforts and new initiatives oriented towards the production and storage in atom or ion traps of highly polarised, high intensity and high purity sources are thus to be pursued. In this context, new and more accurate methods to precisely determine the nuclear polarisation should be developed as well.

### $\beta$ decay correlation coefficients

In  $\beta$  decay the neutron or nuclear with spin  $\mathbf{J}$  emits an electron (or positron) with momentum  $\mathbf{p}$  and spin sigma and an electron (anti)neutrino with momentum  $\mathbf{q}$ . The decay probability can be written as

$$\frac{d^2W}{d\Omega_e d\Omega_\nu} \sim 1 + a \frac{\bar{\mathbf{p}} \cdot \hat{\mathbf{q}}}{E} + b\Gamma \frac{m_e}{E} + \langle J \rangle \cdot \left[ A \frac{\bar{\mathbf{p}}}{E} + B \hat{\mathbf{q}} + D \frac{\bar{\mathbf{p}} \times \hat{\mathbf{q}}}{E} \right] + \langle \sigma \rangle \cdot \left[ G \frac{\bar{\mathbf{p}}}{E} + Q \langle J \rangle + R \langle J \rangle \times \frac{\bar{\mathbf{p}}}{E} \right]$$

where the correlation coefficients, i.e.  $a$ ,  $b$ ,  $A$ ,  $B$ ,  $D$ ,  $G$ ,  $Q$  and  $R$ , depend on the coupling constants and on the nuclear matrix elements. For pure Fermi or Gamow-Teller  $\beta$  transitions these coefficients are independent of the matrix elements and thus, to first order, of nuclear structure effects, and depend only on the spin of the initial and final states. The description of  $\beta$  decay, and of the weak interaction in general, in terms of exclusively vector (V) and axial-vector (A) interactions, i.e. the V-A theory as part of the SM, found its origin in measurements of the beta-neutrino correlation coefficient  $a$ . The discovery of parity violation was made from the observation that the beta asymmetry correlation coefficient  $A$  is non-zero. In the SM the Fierz interference term  $b$  vanishes, while the time reversal violating correlations characterized by the  $D$  and  $R$  coefficients should be zero, apart from small and calculable final state effects. Selecting the appropriate initial and final states one can select either the V or A interaction in Fermi or Gamow-Teller  $\beta$  transitions, respectively, allowing one to search for as yet unobserved scalar (S) or tensor (T) contributions by observing the characteristic decay.

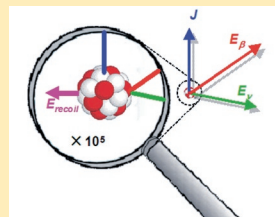

In practice the neutrino momentum  $\mathbf{q}$  cannot be measured. It is therefore necessary to measure the recoil momentum of the nucleus to determine the full correlation. The accuracy of such measurements is hampered by the low kinetic energies,  $E_{\text{recoil}}$ , of the recoiling nucleus. This has become possible recently by using atom and ion traps to store the radioactive nuclei in vacuum, allowing one to accurately measure the direction and energy of the recoil.



---

### New time reversal invariant scalar and tensor interactions

As to time reversal invariant scalar (S) and tensor (T) interactions, the  $\beta\nu$ -correlation coefficient  $a$  (which is sensitive to S and T) and the  $\beta$  asymmetry and neutrino asymmetry parameter,  $A$  and  $B$ , respectively (which are both mainly sensitive to T) provide the best prospects. Over the past years significant progress has been made in the precision of all three observables.

Atom and ion traps have by now become a standard for measuring the  $\beta\nu$ -correlation. Several measurements have already reported a precision of about 0.5% while several other experiments are in progress or in preparation. Whereas this type of activity was started in North America with atom traps, Europe is catching up now with both atom and ion traps being used. For example RF and Penning trap based ion trap experiments are ongoing at GANIL (the LPC-TRAP experiment) and ISOLDE (the WITCH experiment), respectively, while a neutral atom trap based experiment is being set up at KVI-Groningen. In free neutron decay an experiment using a retardation spectrometer (aSPECT) is well on its way to reach a similar precision.

Recently, significant progress has also been made in the determination of the  $\beta$  asymmetry parameter, in both trap based and low temperature nuclear orientation experiments with nuclei, as well as in neutron decay. Monte Carlo simulations have played a crucial role in this. Finally, new measurements of the neutrino and recoil ion asymmetries have become available as well, both in neutron decay and nuclear  $\beta$  decay.

Further progress in the search for time reversal invariant S and T currents at low energies would highly benefit from further improvements of the simulation codes with respect to scattering of keV to MeV  $\beta$  particles, as well as from new and more precise methods to determine the degree of nuclear polarisation. Increased yields as can be expected e.g. at DESIR, HIE-ISOLDE and EURISOL for nuclei, and at ILL, FRM-II, PSI and the European Spallation Source for neutrons, are a further important asset. Further, methods should be developed to store polarised isotopes also in ion traps (Paul and Penning traps), as this would significantly extend the number of accessible isotopes. In neutron decay the planned PERC facility will allow for higher precision in the determination of all three relevant correlation coefficients, i.e.  $a$ ,  $A$  and  $B$ . With all these improvements precisions at the  $10^{-3}$  level and beyond are within reach. Also in this case the efforts in the US mentioned in the previous section will provide important contributions.

## 4.5.3 Discrete Symmetries

The three discrete symmetries in Nature are:

- charge conjugation C (i.e. exchanging particles by their antiparticles),
- parity change P (i.e. the mirror inversion of space coordinates), and
- time reversal T.

CPT invariance is one of the most important symmetries of Nature. It states that these three operations when performed simultaneously do not change the measurable physical properties of a system. A number of experiments to improve bounds on discrete symmetries is going on worldwide, which all have the potential to produce surprises.

### Parity

#### Atomic parity violation

Atomic parity non conservation (APNC) experiments are a fundamental tool in testing our understanding of the electroweak interaction. The observation of parity non conservation in atoms (and then in the deep inelastic electron-deuteron scattering) led to the discovery of the weak electron-nucleon interaction due to neutral currents. Recent APNC results have reached a level of precision to provide powerful constraints on new physics beyond the SM.

Parity violation in atomic systems arises from the interference between the parity conserving electromagnetic interaction and the parity violating weak interaction. Although most of the binding energy of the atomic electrons comes from their attractive Coulomb interaction with the Z protons in the nucleus, the weak electron-nucleus interaction mediated by the exchange of neutral gauge bosons  $Z^0$  induces a small correction in the binding energy and parity of the electronic wave functions. This correction results in an electric dipole amplitude between two electronic states that in the absence of parity violating effects would have the same parity, i.e. forbidden transitions.

The dominant (and nuclear spin-independent) part of the parity non conserving Hamiltonian depends on the weak charge  $Q_w$ , which contains the SM coupling constants. The weak charge is extracted from the experimental data combined with accurate calculations of the electronic wave functions. The observation of deviations between the values measured in the laboratory and the predictions of the SM in high precision APNC

## 4.5 Fundamental Interactions

experiments can lead to the discovery of new physics beyond the SM. At low momentum transfer, as is the case in APNC experiments, new particles predicted for instance in supersymmetric or in technicolor models generate additional electron-quark PNC interactions.  $Q_w$  can be sensitive to new corrections, both weak isospin-conserving and isospin-breaking, and to extra Z bosons, providing more stringent bounds than direct searches at high energy colliders.

On the experimental side, one has to consider that effects are very small and the analysis of APNC experiments is complicated by the uncertainties in both atomic and nuclear-structure theory. Weiman and collaborators measured the amplitude of the parity non-conserving transition between the 6S and 7S states of  $^{133}\text{Cs}$ , the only naturally occurring cesium isotope. Taking into account recent improved atomic calculations, the value of the weak charge deduced from this is  $Q_w^{\text{exp}} = 73.16(29)_{\text{exp}}(20)_{\text{th}}$  in perfect agreement with the SM prediction of  $Q_w^{\text{exp}} = 73.16 \pm 0.03$  (see also Figure 4). In this context, it is important to make new precise measurements of the APNC effect with high-Z atoms (e.g. francium), since the parity non conserving effect increases faster than  $Z^3$ . Francium trapping is currently carried out at LNL (TRAPPRAD experiment) and in preparation at TRIUMF (Canada) and RCNP/CYRIC (Japan). Recently a strong APNC effect has been observed in Ytterbium but, due to the complicated atomic structure, this atom is less suitable for SM tests.

Another important field of investigation is the test of single ions (like  $\text{Ba}^+$ ,  $\text{Ra}^+$ ) confined in radiofrequency traps: in particular, the  $\text{Ra}^+$  experiment has the poten-

tial to improve significantly the cesium result. A proof of principle for several important aspects of a parity non conservation experiment with one single  $\text{Ba}^+$  ion has been obtained by Fortson et al. in Seattle. At KVI Groningen such an experiment with one single  $\text{Ra}^+$  ion is being set up now; the production, trapping and laser spectroscopy has recently been achieved for several  $\text{Ra}^+$  isotopes.

In this perspective, techniques to produce and trap large amounts of radioactive atoms and ions are crucial: important steps have already been done in this field in the past few years, and the upgrade of KVI and LNL facilities in the trapping sector would be very important in this context.

Uncertainties in atomic structure, which play an important role for the extraction of the weak charge, may be considerably reduced by studying parity violation along a chain of isotopes. In this way the dependence on the atomic theory contribution of the parity violating amplitude measured in an APNC experiment will cancel out in the ratio of two measurements performed on two different isotopes of the same element, provided that the atomic contribution does not change appreciably along that isotopic chain. In particular, it would be very valuable to extend the measurements which have proved successful for natural cesium, i.e.  $^{133}\text{Cs}$ , to some of its numerous radioactive isotopes, and in future to a series of Fr isotopes as well. Alternatively one can study parity violation in heavy highly charged ions where the electron-correlation and QED effects can be well accounted for by perturbation theory. Again the strong increase of the parity effect with increasing Z and the near degeneracy of atomic levels with opposite parity would be an asset.

Interpretation of PNC effects will also require, once a certain precision level is reached, to take into account nuclear structure effects that enter through the density distributions of nucleons. Complementary experiments to precisely measure these will be an important issue.

Finally, another important goal to be pursued is the measurement of the nuclear anapole moment. Up to now, this has been detected only for  $^{133}\text{Cs}$  (an even neutron-number isotope), and it would be important to measure it for another isotope (in particular one with an odd neutron-number) as well.

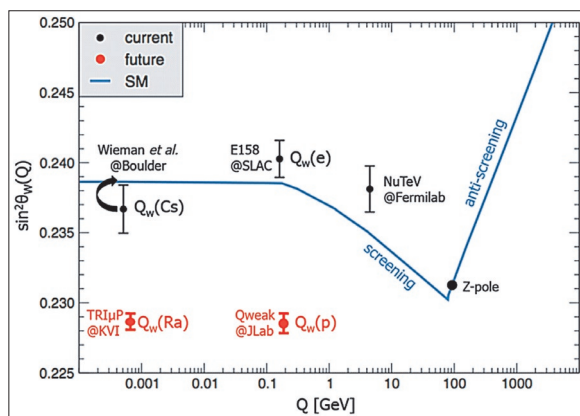

**Figure 4.** Overview of determinations of the weak mixing angle,  $\theta_w$ , at different energies, compared to theoretical expectations (full line). With respect to the present chapter the value at low energies that was obtained from atomic parity violation experiments with cesium is especially important. Red points indicate expected sensitivities of planned atomic parity violation and electron scattering experiments.

### Parity violation in electron scattering

Parity-violating electron (or neutrino) scattering (PVeS) experiments have developed into a high-precision tool to determine the weak neutral-current electron–electron and electron–quark coupling constants (see also the chapter on Hadron Physics). The parity-violating observables are

due to the interference of photon and  $Z^0$  exchange. From the measurements, the weak mixing, or Weinberg, angle at low momentum transfers can be extracted, providing powerful constraints on TeV-scale physics, for example additional neutral gauge bosons, SUSY, and leptoquarks. In recent years, two experiments have been completed. The Møller scattering experiment E158 at SLAC agrees with the SM prediction for the weak mixing angle within about one sigma. The NuTeV experiment, (anti)neutrino scattering from iron, however, deviates from the SM by about three sigma. The overall agreement of the APNC and PVeS experiments with the SM prediction for the running of the Weinberg angle from the  $Z^0$ -pole down to low energies ( Fig.4), is poor at the moment, and it is apparent that more precise experiments are called for. The Qweak experiment at JLab measures the parity-violating asymmetry in polarised-electron scattering from protons at  $Q^2 = 0.03 \text{ GeV}^2/c^2$ . The goal is to extract the weak charge of the proton,  $Q_w^p = 1 - 4\sin^2\theta_w$  with a combined statistical and systematic error of 4%, providing a 0.3% measurement of  $\sin^2\theta_w$ . After the completion of the Qweak experiment and the realisation of the 12 GeV JLab upgrade, two new PVeS experiments are planned. A parity-violating Møller scattering experiment at 11 GeV will measure the weak charge of the electron with much better precision. A deep-inelastic electron–proton scattering experiment will provide new information on the parity-violating electron–quark interaction, in particular the axial-vector quark couplings, which are very difficult to measure with other low-energy techniques. This experiment not only tests the electroweak sector of the SM, but it will also provide information on novel aspects of the QCD (parton) structure of nucleons.

Note that parity-violating elastic electron scattering from nuclei (e.g. lead) is being pursued at JLab. Finally, in the long-term future a high-energy polarised-electron light-ion collider could provide new opportunities to measure the weak-mixing angle to ultra-high precision.

### Parity violation in hadronic systems

The standard model of particle physics provides a well-established description of the fundamental weak interaction between quarks but how it manifests in the hadronic environment still remains enigmatic, e.g. parity-violating asymmetries observed in non-leptonic decays of hyperons still cannot be reconciled with theoretical expectations. Current studies to shed more light on the interplay between weak and strong interactions mostly rely on parity violation as an experimental filter to discriminate the much larger effects due to strong and electromagnetic interactions. While peculiar enhancement effects facilitate the observation of hadronic weak interaction processes, they obscure the link to the

underlying theory framework, for which parity violating asymmetries in few-nucleon systems without enhancement offer much cleaner conditions.

A recent effective field theory approach provides a model-independent framework to describe the weak forces between nucleons and makes close contact with QCD. However, so far only few observables in few body systems have provided non-zero results, such as the longitudinal analysing power in pp scattering at Bonn, PSI and TRIUMF, and the triton asymmetry in polarised neutron capture by  ${}^6\text{Li}$  at the ILL. The prospect of obtaining from effective field theory accurate predictions for parity violating observables in hadronic few-body systems has motivated strong new efforts in the US. However, these experiments are very challenging in view of the smallness of the expected asymmetry effects.

### Time reversal and CP violation in the quark sector

If one assumes CPT to be conserved, time reversal violation and CP violation are equivalent. So far, CP violation has been observed in the neutral K and B meson systems, and is usually believed to be manifest also in the huge baryon asymmetry of our universe. While the SM, via a complex phase in the CKM matrix, perfectly describes the observed CP violation in the  $K^0$  and  $B^0$  systems, it completely fails, together with standard cosmology, to explain the observed baryon asymmetry. Another CP violating phase is present in the SM in QCD, the so called  $\theta$ -term, which is constrained by experiment to be very small, i.e. less than  $\sim 10^{-10}$ . Additional sources of CP violation appear to be necessary and are naturally found in most popular extensions of the SM offering a variety of complex phases.

Searches for new CP violation, or equivalently for time reversal violation, can be pursued by more precisely investigating the known CP violating channels or by concentrating on observables with negligible SM background, thereby increasing the sensitivity to any kind of new effect. Examples comprise time reversal violating  $\beta$  decay correlations, effects in the neutral D-meson system and permanent electric dipole moments (EDMs).

### Electric dipole moments

Any permanent electric dipole moment of a fundamental quantum system would violate invariance under time reversal. Experimentally, so far, no finite value of any such permanent EDM has been found and experiments today are not yet sensitive enough to detect the small EDMs due to the known SM contribution. They are, however, probing and so far excluding many models

## 4.5 Fundamental Interactions

of CP violation beyond the SM. Because of many possible theoretical scenarios and many possible sources of additional CP and time reversal violation, EDMs can show up in different systems differently: searches for EDMs of leptons (electrons, muons, taus, neutrinos) and baryons (neutrons, protons, nuclei) are complementary and test different parts of the models' parameter spaces. Once an EDM has been discovered in one system, the models should quantitatively predict EDMs in the other systems and can, therefore, be discriminated.

For some fundamental particles, e.g. quarks, EDMs cannot be measured directly. If, for instance, a finite neutron EDM is found, it could be due to quark EDMs but could also be induced via colour EDMs. For electrons, there are technical reasons to prefer composite systems over the bare lepton. The electron EDM in a heavy paramagnetic atom can be considerably enhanced (the present limit for the electron EDM,  $d_e < 2 \times 10^{-27} e \text{ cm}$ , is deduced from the EDM of  $^{205}\text{Tl}$  using an enhancement factor of  $d_{\text{Tl}} = -585 \times d_e$ ). Large enhancement factors together with very strong internal electric fields can make polar molecules even more sensitive. While measurements of the electron EDM using paramagnetic atoms seem to be close to their systematic limits, polar molecules are expected to push the sensitivity further down by two orders of magnitude. The YbF molecule (used at Imperial College, London) might give a next step in electron EDM sensitivity. Several other candidate molecules (such as PbO, PbF, ThO, HfO<sup>+</sup>) are being investigated at various places in the US. There, research is also ongoing concerning the possibility of extracting an electron EDM from measurements using paramagnetic insulating solids inducing a magnetic polarisation with the application of an external electric field or, vice versa, an electric polarisation with an applied magnetic field. For composite systems one must keep in mind that the interpretation of a possible finite result is usually not straightforward. While for the solid state systems one may expect all kinds of solid state effects and issues of purity. Furthermore EDMs of polar molecules and heavy atoms could be not only induced by electron EDMs but also for example by CP violating lepton–nucleon forces. So far, however, finding no finite EDM, one usually assumes no cancellation of two new effects when deducing  $d_e$  limits.

Diamagnetic atoms are used to search for nuclear EDMs. The best limit on any EDM today is from the University of Washington, Seattle, on  $^{199}\text{Hg}$  with  $d_{\text{Hg}} < 3 \times 10^{-29} e \text{ cm}$ . Here, instead of enhancement, the electron shell leads to some suppression of the nuclear EDM effect. The extraction of the EDMs of the more fundamental constituents involves atomic and nuclear modeling, which introduces some uncertainties, but finally the results are complementary to, e.g., measurements of the neutron EDM. Other searches for EDMs of heavy

nuclei will use hyperpolarised liquid  $^{129}\text{Xe}$  (Princeton, TU Munich),  $^{223}\text{Rn}$  (TRIUMF) or  $^{225}\text{Ra}$  (Argonne National Lab, KVI Groningen). For the latter cases large enhancement factors are expected due to the presence of almost degenerate opposite parity states leading to large amplification of the sensitivity to CP violating effects.

The classic target for EDM searches is the neutron. The present limit is  $d_n < 3 \times 10^{-26} e \text{ cm}$  (Sussex-RAL-ILL). Today, at least four collaborations worldwide aim at improving the sensitivity of next neutron EDM measurements by about two orders of magnitude, three of which are located in Europe, two at ILL Grenoble and one at PSI Villigen; the fourth is located at the SNS facility in Oak Ridge. Previous statistical limitations of neutron EDM searches may be overcome by new sources of ultracold neutrons at ILL, PSI and FRM-II. Together with the mercury experiment, the neutron EDM limits the QCD  $\theta$ -term and, as with the other EDMs, any improvement in experimental sensitivity may lead to a discovery or will at least continue to severely constrain physics beyond the SM. The advantage of the neutron is, for a baryonic system, the relative ease of interpreting the results, without involving atomic or nuclear calculations.

New opportunities to search for EDMs of charged particles using storage rings have developed out of the experience of the Brookhaven National Lab based muon (g-2)-collaboration. The present limit for the muon,  $d_\mu < 2 \times 10^{-19} e \text{ cm}$ , is a byproduct of this experiment. A dedicated muon EDM experiment in a storage ring could improve on this limit by up to six orders of magnitude, with the available muon fluxes being the major limitation. In most models the lepton EDMs scale with the lepton's mass, but some models predict a large muon EDM together with a very small electron EDM. In case at some point such models would appear to be favoured, e.g. by some other EDM findings or discoveries at the LHC, an improvement of three to four orders of magnitude in muon EDM sensitivity could be achieved at PSI. Further improvements would need higher, pulsed

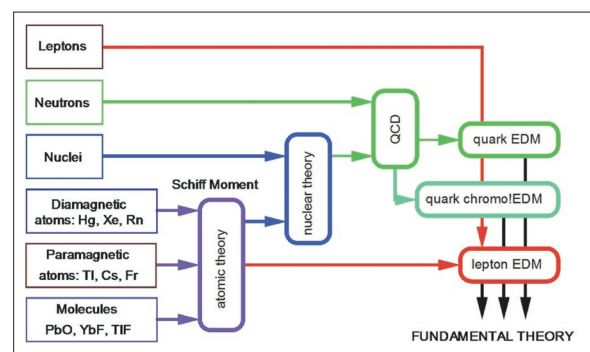

Figure 5. The EDM landscape



muon intensities. These could be achieved for example at the European Spallation Source that is due to be built in Sweden. Another particle considered for a ring EDM experiment is the deuteron, for which a sensitivity of  $10^{-29}$  e cm might be achievable. Design studies, particularly on spin dynamics in a ring and on deuteron polarimetry using nuclear scattering, are presently being performed at the COSY facility in Jülich, with the aim of performing a deuteron EDM experiment in the near future.

### Decay correlations

Observables for testing time reversal violation in particle decay or reactions can be constructed by combining appropriate vectors and axial vectors. Time reversal violation in nuclear strong interactions can usually be addressed with more sensitivity from limits on neutron and nuclear EDMs.

Important TRV observables are available in  $\beta$  decays of leptons and hadrons (e.g. muons, neutrons, nuclei, hyperons). Experimentally accessible are triple correlations of parent particle spins,  $J$ , and decay lepton momenta,  $p$ , and spins,  $\sigma$ . The triple correlation between parent spin,  $\beta$  particle momentum and neutrino momentum is conventionally referred to as the D coefficient, while the R coefficient labels the correlation between parent spin,  $\beta$  particle momentum and spin:

$$D \propto \frac{\langle \vec{J} \rangle \cdot \vec{p}_e \times \vec{p}_\nu}{J E_e E_\nu} \text{ and } R \propto \vec{\sigma}_e \cdot \frac{\langle \vec{J} \rangle \times \vec{p}_e}{J E_e}$$

The TRV contribution in D would be from a phase between vector and axial vector coupling, in R from tensor and scalar couplings.

The best limits on D come from  $^{19}\text{Ne}$  decay,  $D_{\text{Ne}} = (0.1 \pm 0.6) \times 10^{-3}$  (Princeton), and from neutron decay,  $D_n = (0.4 \pm 0.6) \times 10^{-3}$  (NIST, ILL), on R from  $\beta$  decays of  $^8\text{Li}$  and neutrons (both PSI):  $R_{\text{Li}} = (0.9 \pm 2.2) \times 10^{-3}$  and  $R_n = (0.8 \pm 1.5 \pm 0.5) \times 10^{-2}$ .

Further improvements of the sensitivity in D and R correlation experiments appear possible, both with

neutrons as well as with light nuclei, eventually using trapped radioactive atoms or ions at radioactive beam facilities.

Investigating TRV observables in other than nucleonic systems remains of interest for various reasons; for example, the pure leptonic character of the muon system and the absence of electromagnetic final-state interactions. Superior sensitivity could be obtained by improved positron polarimetry at existing facilities or via improved counting statistics at future production facilities for muon neutrinos.

### CPT and Lorentz invariance

The principle of relativity in four-dimensional space-time implies that the laws of physics are Lorentz (Poincaré) invariant, that is, they are invariant under translations, rotations, and boosts (velocity transformations). Lorentz invariance is a cornerstone of modern physics: when combined with the principles of quantum mechanics, it leads to the framework of relativistic quantum field theory for the description of the interactions of elementary particles. Lorentz invariance is at the basis not only of the SM, but also of extensions of the SM, such as supersymmetry, that are formulated in terms of a local quantum field theory. Lorentz invariance is intimately connected to CPT invariance: Lorentz invariance is needed to prove CPT invariance in a quantum field theory, and, equivalently, CPT violation implies the violation of Lorentz invariance. CPT invariance is valid in a local and causal Lorentz-invariant quantum field theory; to break it, one must give up locality, causality, and/or Lorentz invariance. Numerous experiments so far have confirmed that Lorentz and CPT invariance are valid at presently accessible energies and precisions; violations, if they exist, must be very small. Nevertheless, there are excellent reasons to test their validity as exact symmetries as accurately as possible. All the symmetries of physics are based on a priori theoretical assumptions that Nature may not respect and that therefore need to

**Table 3.** Status of electric dipole moment searches.

| Particle               | Experimental method                        | Limit (e cm)          | SM value (factor to go) | New physics (factor to go) |
|------------------------|--|-----------------------|-------------------------|----------------------------|
| electron               | thallium beam                              | $1.6 \times 10^{-27}$ | $10^{11}$               | 1                          |
| muon                   | magnetic storage ring                      | $1.9 \times 10^{-19}$ | $10^8$                  | 200                        |
| neutron                | ultracold neutrons                         | $2.9 \times 10^{-27}$ | $10^4$                  | 30                         |
| proton                 | thallium spin resonance                    | $3.7 \times 10^{-23}$ | $10^7$                  | $10^5$                     |
| $^{199}\text{Hg}$ atom | spin precession in external E and B fields | $3.7 \times 10^{-26}$ | $10^5$                  | various                    |

## 4.5 Fundamental Interactions

be tested experimentally. The validity of Lorentz and CPT invariance ultimately rests on experiment.

A concrete motivation to search for violations of Lorentz and CPT invariance is found in modern attempts to unify the SM with the fourth fundamental force, gravity. In such unified theories, formulated at the Planck scale, plausible mechanisms have been identified that result in a violation of Lorentz invariance at low energy. For instance, in string theory, spontaneous breaking of Lorentz invariance can occur, resulting in vacuum expectation values for Lorentz tensors. Hence, the fascinating possibility exists to detect such suppressed signals from the Planck scale in dedicated, high-precision experiments at low energy. In the context of cosmology, Lorentz and CPT violation could have major implications as well. CPT violation can replace two of the three Sakharov conditions that are required to generate the matter–antimatter asymmetry of the Universe (viz. violation of CP invariance and the deviation from thermal equilibrium), and thereby offers an alternative scenario for baryogenesis.

CPT invariance implies that particles and antiparticles have related properties, in particular the same mass and opposite signs for internal charge-like quantities such as electric charge, colour, and lepton and baryon number. A direct sensitive test of CPT invariance is to measure these properties for both particles and antiparticles. The masses of the neutral kaon and antikaon are presently the most precise such comparison, with a relative difference at the level of  $10^{-18}$ . Figure 6 shows the comparison of the accuracy reached in such CPT invariance tests for several quantities of various particles and systems. The charge-to-mass ratio of the proton and antiproton was compared at LEAR via measuring cyclotron frequencies in a Penning trap. The difference

was found to be less than about  $10^{-10}$ . A similar stringent CPT test at this level is possible by comparing the magnetic moments of the proton and antiproton stored in a Penning trap, as is being prepared at several laboratories. At present, the only facility to perform such experiments is the Antiproton Decelerator (AD) facility at CERN, constructed in 1999 in order to test CPT invariance for antiprotons and antihydrogen.

The AD experiments ATHENA, ATRAP, and ALPHA have produced and studied antihydrogen atoms and are making progress towards confinement and spectroscopy. The ASACUSA collaboration has produced and studied antiprotonic helium and measured the mass, charge, and magnetic moment of antiprotons bound in atomic orbits by laser spectroscopy. The antiproton-to-electron mass ratio was found to be equal to the proton-to-electron one at the  $10^{-9}$  level (Figure 7), implying CPT tests for the relative differences of the proton and antiproton charges and masses at this level. Since this community is expanding, it will soon face a need for antiproton beams. A short-term solution is the ELENA storage ring at CERN, while possibilities for the longer-term future are provided by the FAIR facility at GSI-Darmstadt.

Finally, CPT relates closely to spin-statistics that is addressed in experiments testing the Pauli principle as for example at the Gran Sasso laboratory.

The violation of Lorentz invariance generically results in unique signals, in particular rotational, sidereal, and annual variations of observables that in Lorentz-invariant theories, such as the SM and its generally considered extensions, are constant. Such effects translate e.g. into the presence of a preferred direction parameterised by a *constant* vector in expressions for measurable quantities. In other words, Lorentz violation results in a frame dependence of the observables, where the preferred inertial frame is fixed at a cosmological scale (this frame might be identified, for instance, with the frame of the cosmic microwave background). Over the course of the last decade, there has been significant experimental activity to search for such signals in various physical systems. Many of these dedicated experiments, especially those in electrodynamics and optics, involve high-precision searches using the sharpest weapons of atomic physics, such as lasers, atom or ion traps and storage rings. However, clock comparisons mounted on space missions have also been proposed. Signals of Lorentz and CPT violation have also been looked for in the neutral-kaon system, in neutrino oscillations, in the muon  $g-2$  experiment, etc.

A model-independent effective field theory has been developed by Kostelecký and collaborators to quantify possible signals of spontaneous Lorentz and CPT viola-

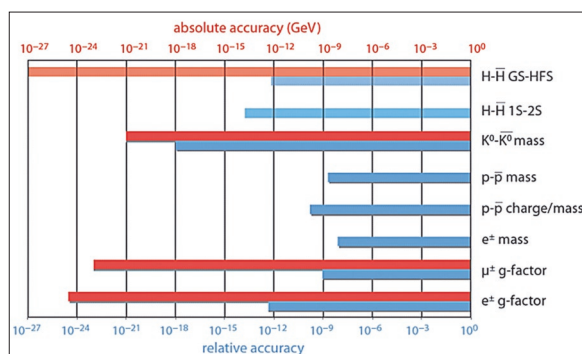

**Figure 6.** Comparison of several CPT tests in terms of relative accuracy (blue) and absolute accuracy (red) based on the Standard Model Extension model of Kostelecký *et al.* Values for hydrogen–antihydrogen comparison assume that antihydrogen will be measured to the same precision that has been achieved for hydrogen.

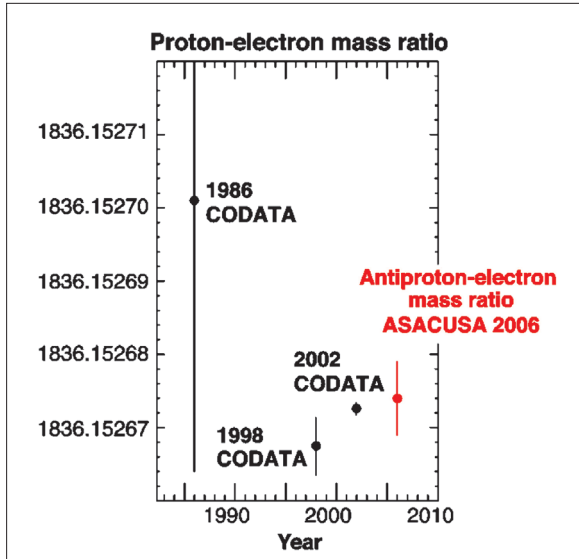

**Figure 7.** Progress in the proton-to-electron and antiproton-to-electron mass ratio over time.

tion. This comprehensive and consistent framework is called the Standard Model Extension (SME). It consists of the SM (coupled to general relativity) extended with all possible operators that violate Lorentz invariance. The minimal version of the SME includes only the Lorentz-violating operators of mass dimension three or four, about half of which violate CPT invariance. The coefficients multiplying these operators are dimensionless or have positive mass dimension. Many of the experiments have been analysed within the framework of this minimal SME (see Figure 5). So far, no deviation from Lorentz and CPT invariance has been found, and several experiments have put stringent upper limits on the SME coefficients. However, a large part of the parameter space has not been investigated experimentally yet.

#### 4.5.4 Properties of Known Basic Interactions

The weak interaction has been dealt with extensively in the previous sections. This contains a number of fundamental constants, several of which have recently been determined with improved precision, e.g. a new measurement of the muon lifetime has recently provided a more precise value for the Fermi coupling constant  $G_F$ , while measurements of the muon capture on protons have provided the pseudoscalar coupling constant  $g_p$ . In the following sections we will concentrate on the other basic interactions, which also allow for the determination of a number of fundamental constants and searches for physics beyond the Standard Model.

#### QED and fundamental constants

Quantum electrodynamics (QED), the quantum theory of electromagnetic interactions, is a cornerstone of the Standard Model. It has been intensively tested and verified by comparison against precise measurements on free elementary particles, the hydrogen atom, and other simple atomic systems. The measurement of the  $2S_{1/2} - 2P_{1/2}$  transition frequency in hydrogen by Lamb and Rutherford in 1947, which according to Dirac theory vanishes, stimulated the development of the covariantly renormalised QED. Recently, precisions at the  $10^{-13}$  level were achieved in direct measurements of optical transitions, such as the  $1S-2S$  or the  $2S-nS$  hydrogen transitions. At this level of sensitivity, apart from verifying QED theory, fundamental physical constants can be obtained with a very high accuracy. This, however, requires a good understanding of the proton and in general nuclear structure effects, such as charge radii or polarisabilities. In fact all QED tests with the hydrogen atom are limited by the uncertainty in the proton electric or magnetic radii. Since, at present, no QCD implementation allows for their accurate evaluation, these radii have to be determined experimentally, for example by low energy electron scattering or through the measurement of the Lamb shift in muonic hydrogen (at PSI). At the time of writing this report, these experimental results are not yet officially available, but preliminary results indicate intriguing discrepancies for the proton charge radii. Nevertheless, accurate determinations of these quantities are of utmost importance for improved tests of QED with the hydrogen atom.

#### g-2 measurements

Since the original calculations of Bethe, Feynman and others of the hydrogen Lamb shift, QED has been under

## 4.5 Fundamental Interactions

---

intensive development in various directions. The deviation of the free electron  $g$ -factor from the Dirac value  $g = 2$  has become the most significant QED test. The magnetic moment anomaly  $a = (g-2)/2$  is the only possible extension of the electromagnetic interaction of a spin 1/2 particle, which does not violate parity and time reversal symmetries. It has been calculated very accurately over many years including all 4-loop diagrams and partially the 5-loop diagrams. The comparison with recent precise measurements of the electron anomaly in a Penning trap performed at Harvard University has led to the most accurate value of the fine structure constant  $\alpha$ . The magnetic moment anomaly of the muon has been measured with 0.5 ppm precision at the Brookhaven National Laboratory. Since the muon is 200 times heavier than the electron, its anomaly is much more sensitive to the existence of as yet unknown heavier elementary particles, which may significantly contribute to  $a_\mu$ . It is also sensitive to the so called hadronic contribution, the major part of which can be obtained from the  $e^- - e^+$  annihilation or hadronic  $\tau$ -decays. However, a small part, the so called light-by-light hadronic correction, can only be obtained from theory. Both hadronic corrections limit the present accuracy of theoretical prediction, which somehow deviates from the experimental value by more than  $3\sigma$ . This might be due to new physics and therefore a new experiment at the Fermilab accelerator complex is in preparation with the aim of a fivefold improvement of the muon  $g-2$ . The hadronic corrections need more precise experimental input and thorough theoretical scrutiny. Here European experimental and theoretical work is playing a central role. If at the end of the next round experiment and theory would happen to agree, this would provide best limits for numerous parameters in theories beyond SM. Therefore the muon  $g-2$  value is a crucial calibration point for speculative theories as well as for the SM itself.

### Light hydrogenic ions

Within the direction toward high precision tests with light hydrogenic ions, various QED effects such as one-, two- and three-loop contributions to the Lamb shift and to the hyperfine splitting have been calculated using both analytic and numerical approaches, and in general good agreement between different calculations has been achieved. Also, by combining experimental and theoretical efforts, the charge radius of halo nuclei (e.g.  $^8\text{He}$ ,  $^{11}\text{Li}$  and  $^{11}\text{Be}$ ) were recently determined for the first time and model-independently. Further on, the finite nuclear mass effects, which are significant for such systems as positronium, muonium, muonic and pionic hydrogen, and even hydrogen, have been studied intensively during recent years as their evaluation was found to be the most challenging. Theoretical predictions for positronium,

its energy levels and decay rates, were found to be in agreement with results from the most recent experiments, although significant discrepancies were present with early measurements, in particular with the ortho-positronium decay rate. This has stimulated development of various speculative theories, as the ortho-positronium decay is sensitive to an admixture of new interactions, which are not accommodated in the Standard Model. Theoretical results for another very interesting pure QED system, i.e. muonium  $e^- + \mu^+$ , are so accurate that they have the potential of determining physical constants, like  $\alpha$  or the muon mass, provided the measurements reach a similar level of accuracy. Such experiments are being considered for example at PSI, where high intensity muon beams are available. Interestingly, in hydrogen-like ions theoretical predictions for the bound electron  $g$ -factor have led to the most accurate determination of the electron mass from precise measurements of the ratio of Larmor to cyclotron frequencies of a single hydrogen-like  $\text{C}^{5+}$  ion stored in a tandem Penning trap. Regarding hadronic atoms, although pure QED effects can be obtained as accurately as for hydrogen, the mixed QED and strong interaction effects cannot at present be consistently calculated, an example of this being the pion self-energy in the pionic hydrogen. The problem of mixed QED and QCD corrections may therefore deserve further consideration.

### Light few-body atoms

The third direction in the development of QED has been the light few-body atoms helium, lithium and exotic counterparts, such as antiprotonic helium. Comparing theoretical predictions with experimental results, such as the recent measurement of the helium ionisation energy, provides high precision QED tests. Further on, accurate theoretical predictions, as for the helium fine structure, allow for the determination of the fine structure constant  $\alpha$ . At present however, this determination is not as accurate as that from the electron  $g$ -factor. Nevertheless, measurements of  $\alpha$  by different methods provide a sensitive test of consistency of theory across a range of energy scales and physical phenomena. Particularly interesting in this respect is antiprotonic helium, where one of the electrons is replaced by an antiproton. This is the hadronic system that allows the highest precision tests of long range interactions between hadrons to be performed. The agreement of QED predictions with experimental results of the ASACUSA collaboration demonstrates the universality of QED theory and will soon make possible the accurate determination of the antiprotonic mass and the magnetic moment or even the electron mass. This requires, however, evaluation of challenging higher order QED effects, which so far have been investigated only for the simplest systems, such as the hydrogen atom.



---

## Highly-charged ions

The fourth direction in high precision tests of QED is research with middle range and even heavy ions in the highest charge states, i.e. bare ions, hydrogen-like ions or few-electron systems. Calculations have recently achieved such a degree of accuracy that these systems now offer a testing ground of QED in the presence of strong electric fields. This needs equally accurate experiments, which involve charge breeding in electron beam ion traps (EBIT) or electron stripping at relativistic energies in accelerator facilities, cooling and storing in ion traps or storage rings. Such experiments will also benefit from the recent development of high-power lasers such as PHELIX at GSI or intensive free electron lasers. Upcoming facilities will provide high-flux photon beams with energies up to the keV region enabling, for example, fundamental photon-atom interaction studies such as precision spectroscopy of highly charged ions. Further on, experiments on stored and cooled beams of heavy ions in the highest charge states up to uranium  $U^{92+}$  (where the binding energy becomes comparable to the electron mass), for example the precise measurement of the ground-state Lamb shift, have already been conducted in the Experimental Storage Ring ESR at GSI. The HITRAP facility, a Penning trap setup for accumulating and storing highly charged ions up to bare  $U^{92+}$ , will allow for high-accuracy measurements of the Lamb shift, the ground-state hyperfine splitting, or the g-factor of the bound electron in an ion of the very same isotope with up to four electrons. Here, nuclear structure effects can be eliminated to a large extent and high-Z QED can be tested without major distortion by the nuclear size. This opens up an alternative route to an accurate determination of the fine structure constant. Also important is the possibility of accurately measuring the magnetic moment of a heavy ion (at HITRAP in GSI). This may allow one of the most accurate determinations of the nuclear magnetic moment, free of nuclear structure uncertainties, and free of theoretical uncertainties in the shielding and hyperfine constants. This is in contrast to standard determinations through the hyperfine splitting or NMR technique, where the atomic structure calculations, not considering QED effects, are not accurate enough to reach a similar precision for nuclear magnetic moments. Finally, the unexpected recent observations of non-exponential orbital electron capture decays of hydrogen-like  $^{140}\text{Pr}$  and  $^{142}\text{Pm}$  ions ("GSI oscillations"), which has not yet found a convincing explanation, deserves to be verified.

## Many-electron atoms

In the fifth direction, QED effects are being investigated for many electron atoms in order to obtain accurate energy levels, transition rates, isotope shifts and to

test predictions of the Standard Model for the weak interaction between electrons and nuclei as described in the previous section. However, the current development of accurate atomic structure calculations is less than satisfactory. There is not yet any implementation of QED theory in multi-electron atoms that accounts at the same time for correlations and the electron self-energies. Although this problem has been investigated for a long time, so far no systematic approach has been implemented in the atomic structure codes, so that an accurate treatment of electron correlations and QED effects in many electron atoms deserves further investigation.

Finally, we mention speculative ideas, that fundamental constants such as  $\alpha$  are not constant over the cosmological time, or even on the scale of a couple of years. These ideas are being verified at many laboratories, for example at NIST by a comparison of  $\text{Al}^+$  versus  $\text{Hg}^+$ , the most accurate single-ion optical clocks. As a result  $\dot{\alpha}/\alpha$  cannot be larger than  $10^{-17}/\text{year}$ , which is so far the most stringent limit on the possible time variation of  $\alpha$ .

## QCD and hadronic atoms

Exotic hadronic atoms (see also the chapter on Hadron Physics) have long been used to study the strong interaction between the exotic particle and the nucleus at – as compared to scattering experiments – zero energy, i.e. at threshold. The lowest energy atomic states experience a shift and broadening due to the strong interaction of the exotic hadronic particle and the nucleus, which are usually measured by precision X-ray spectroscopy. Activities with pionic atoms at PSI have been successfully completed, while the DIRAC experiment at CERN is investigating ponium  $\pi\pi$  and  $\pi\text{K}$  atoms. Most activity is concentrated on kaonic atoms and kaonic nuclear bound states, in Europe at LN Frascati and GSI-Darmstadt, and in Japan at KEK and in future at J-PARC. Exotic atoms with more exotic particles like  $\Sigma$  or  $\Xi$  are also planned at J-PARC. Antiprotonic light atoms have been investigated previously at LEAR, but more studies are planned in the future at FLAIR.

## Pionic atoms

The strong interaction at low energies is described by non-perturbative QCD. In the case of pionic atoms, chiral perturbation theory is applicable and the interaction between the Goldstone bosons, the pions, is most easy to calculate. This makes systems like  $\pi\pi$  and  $\pi\text{K}$  most attractive from the theoretical point of view. Experimentally, the lifetime of these atoms in matter –

## 4.5 Fundamental Interactions

which is directly proportional to the scattering length – can be measured and need to be compared to theoretical calculations. The DIRAC experiment at CERN has been measuring the  $\pi\pi$  lifetime and has seen some evidence for  $\pi K$  atoms. This is planned to be continued for the next few years.

At PSI, high-precision X-ray spectroscopy of pionic hydrogen, deuterium,  $^3\text{He}$  and  $^4\text{He}$  has been performed. Very precise values for the iso-scalar and iso-vector scattering lengths are expected from this.

### Kaonic atoms and kaonic nuclear bound states

The SIDDHARTA experiment at LN Frascati is just about to finish data taking on kaonic hydrogen and deuterium. In the kaonic atom case, where due to the presence of the  $\Lambda(1405)$  resonance below threshold chiral perturbation theory is not possible and chiral effective field theories are needed for a good theoretical description, it is necessary to measure both  $K^-p$  and  $K^-d$  to obtain the iso-scalar and iso-vector scattering lengths. While SIDDHARTA will provide a precise value for the shift and width in  $K^-p$ , the very first measurement of kaonic deuterium will probably need to be continued later at LNF or J-PARC.  $K^-^4\text{He}$  and  $K^-^3\text{He}$  have or will be also measured.

The observed strong attraction (below threshold) in  $K^-p$  atoms has led to the prediction of nuclear bound states of  $K^-$  with few nucleons, which have been searched for in several experiments. While conclusive evidence on the existence of such systems is still missing, second-generation experiments are being planned (AMADEUS @ LNF, E15 @ J-PARC) and also their study using production in antiproton-annihilation is planned initially at the AD of CERN, later at FLAIR. These experiments will also employ the detection of decay particles and therefore allow the search for these states both in missing mass and invariant mass spectroscopy, thus having a high probability of unambiguously settling the question on their existence.

### Antiprotonic atoms

Only limited information is available from measurements of protonium,  $p\bar{p}$ , and antiprotonic deuterium,  $\bar{p}d$ , at LEAR. Here the annihilation strength is probed, but at much larger distances (atomic scale) than in normal annihilation processes. Also, the fine and hyperfine structure of the atomic states gives access to information on spin-orbit and spin-spin interaction which yields important constraints to theoretical models. Experiments with light antiprotonic atoms are planned at the FLAIR facility, where a continuous beam is foreseen. First experiments

could be performed at CERN-AD if the planned ELENA ring can be implemented with slow extraction.

## Gravitational interaction

### Gravitational interaction of antimatter

According to the weak equivalence principle (WEP) stating the equivalence of inertial and gravitational mass, particles and antiparticles should experience exactly the same gravitational acceleration towards Earth. While experiments with many different probes have been performed and confirmed the WEP down to an astounding precision of  $10^{-13}$  for ordinary matter, no direct measurement of the free fall acceleration of antimatter have so far been done.

Gravity is many orders of magnitude weaker than the electromagnetic interaction, thus one needs neutral antimatter systems for experimental gravity studies. Antineutrons and antihydrogen are considered to be pure neutral antimatter species. The masses of other atoms like muonium,  $\mu^+e^-$ , and positronium,  $e^-e^+$ , contain sizeable antimatter fractions.

Unfortunately, antineutrons are produced at high energies and cannot be slowed down using nuclear collisions in matter, as for neutrons the annihilation cross section is always larger than that of elastic scattering. The atomic antimatter systems can be formed and, for all species, efforts concentrate on the production of high intensity cold samples. The leptonic systems are very interesting but unfortunately quite short-lived.

Antihydrogen, the bound state of an antiproton and a positron, is intrinsically stable and can eventually be compared to ordinary hydrogen, using the most sensitive atom interferometric and spectroscopic methods. At present the AEGIS experiment at the AD facility at CERN aims to measure the gravitational mass of antihydrogen atoms with a 1% precision. In spite of the modest precision, the first direct measurement of a gravitational effect on antimatter will be scientifically relevant and will pave the way for higher precision studies.

### Non-Newtonian gravity

Theoretical considerations arising from higher-dimensional gravity, gauge forces or massive scalar fields suggest that the Newtonian gravitational potential for masses  $m$  and  $M$  and distance  $r$  should be replaced by a more general expression including a Yukawa term,

$$V(r) = -G \frac{m \cdot M}{r} (1 - \alpha \cdot e^{-r/\lambda})$$

where  $\lambda$  is the Yukawa distance over which the corre-

---

sponding force acts and  $\alpha$  is a strength factor in units of Newtonian gravity, while  $G$  is the gravitational constant. Most interesting, from the experimental point of view, are scenarios where the strength of the new force is expected to be many orders of magnitude stronger than Newtonian gravitation. Such forces are possible via abelian gauge fields in the bulk. The strength of the new force would be  $10^6 < \alpha < 10^{12}$  stronger than gravity, independent of the number of extra dimensions. Theoretical developments support the original proposal of large extra dimensions with bulk gauge field. The basic idea behind another proposal is to modify gravity at small distances in such a way as to explain the smallness of the observed cosmological constant.

For the strength  $\alpha$ , limits at short distances  $\lambda < 10$  nm are derived from neutron-scattering experiments. Other limits on extra forces at larger  $\lambda$  are derived from mechanical experiments, using Casimir or van der Waals force measurements or torsion pendulums. It has been proposed to probe sub-micron forces by interferometry of Bose–Einstein condensed atoms.

In practice, most of the experimental data are subject to corrections, which can be orders of magnitude larger than the effects actually searched for. In micro-mechanical experiments, gravitational interactions are studied in the presence of large van der Waals and Casimir forces, which depend strongly on the geometry of the experiment, and the theoretical treatment of the Casimir effect is a difficult task. Currently, atomic force microscope measurements using functionalised tips determine the limits on non-Newtonian gravitation below 10  $\mu$ m. The best experimental data obtained in this way are at the same level of accuracy (1–2%) as the numerical calculations of the Casimir force.

New proposals have been suggested to test the law of gravitation at small distances using quantum transitions (GRANIT experiment) or interference (qBounce experiment) of quantum states of ultra-cold neutrons in the gravity potential of the earth. These approaches of probing Newtonian gravity are advantageous because of small systematic effects. In contrast to atoms the electrical polarisability of neutrons inducing such Casimir effects or van der Waals forces is extremely low. This together with the electric neutrality of the neutron provides the key to a sensitivity of more than 10 orders of magnitude below the background strength of atoms.

Finally, limits for hypothetical fifth forces with neutrons can be easily interpreted as bounds of the strength of the matter couplings of axions with a range within the ‘axion window’, the only existing limit in the axion window at short distances.

## 4.5.5 Future Directions

Support to resolve the central and intriguing questions in fundamental physics is a priority. The future directions listed below are based upon the available expertise and European facilities. NuPECC’s focus should be concentrated on state of the art possibilities to achieve the goals in the field. Both the availability of skilled researchers in experiment and theory and the accessibility of adequate infrastructure are indispensable for efficient and successful progress toward potentially important discoveries. The challenging physics goals comprise the following key issues:

### Fundamental symmetries

#### Time reversal and CP violation

Searches for permanent electric dipole moments constitute a most promising avenue to new sources of CP violation required for example to understand the matter–anti-matter asymmetry of the universe. Searches in different simple systems like neutrons, atoms and diatomic molecules, muons and ions should be supported as they offer large discovery potential and complementary sensitivities to the underlying sources of CP violation.

#### Parity non-conservation in atoms and ions

High precision parity non-conservation experiments in atoms and ions can lead to the discovery of new physics beyond the SM. Support for experiments which will study parity non-conservation with radioactive cesium, francium and radium or highly charged ions is strongly recommended. Further, measurements on series of isotopes would be essential in order to reduce uncertainties. Improvement in atomic physics calculations of many electron atoms is crucial.

#### CPT conservation and Lorentz invariance

Precision experiments will lead to improved limits on or discoveries of the violation of Lorentz and CPT invariance. A continuous and close collaboration with theorists is essential for these activities.

### Neutrinos

#### Nature and mass of neutrinos

The questions of whether neutrinos are identical to their antiparticles (Majorana) or distinct from them (Dirac) and

## 4.5 Fundamental Interactions

---

what are the absolute neutrino masses and their ordering (hierarchy) are of primary importance. Neutrino-less double  $\beta$  decay experiments and direct neutrino mass determinations from  $\beta$  decay address these questions and should therefore be strongly supported. Improved nuclear matrix element calculations as well as auxiliary measurements are important to derive or constrain the effective Majorana neutrino mass.

### Neutrino mixing parameters and the CP violating phases

The central focus of upcoming and future reactor and accelerator neutrino oscillation experiments is the measurement of the mixing angle  $\theta_{13}$  and the study of the CP violating Dirac  $\delta$ -phase. CP violating Majorana phases will manifest themselves in neutrino-less double  $\beta$  decay experiments and can be studied by comparing the results with those from direct neutrino mass measurements (single  $\beta$  decay) and cosmology. Strong support is needed for R&D studies crucial for such experiments that have tight connection with future radioactive ion beam facilities, such as for example production of high ion intensities for candidate beta-beam emitters.

## Electroweak Interactions

### Precision measurements in $\beta$ decay

Better limits on possible types of new physics will be obtained from a more precise unitary test of the quark mixing matrix. The current puzzle with respect to neutron lifetime should be addressed with high priority. Also, higher precision in correlation measurements is essential to search for non Standard Model weak interactions. Increased exotic beam and neutron intensities, particle traps, including developments to store polarised nuclei, as well as improved simulation codes for keV to MeV electrons are crucial to this.

### Precise QED studies within the Standard Model

Accurate QED predictions and precision measurements are necessary for improved determination of fundamental constants such as  $\alpha$ , magnetic moments, or particle masses. Further developments in atomic structure calculations including QED effects are required to interpret APNC experiments and to extract nuclear properties from precise atomic measurements.

## 4.5.6 Recommendations

In order to achieve the challenging physics goals listed in the previous section the European nuclear physics community needs an appropriate environment consisting of adequate academic positions for young researchers and state of the art facilities. These comprise centrally:

### Priority 1. Support of small-sized laboratories and university groups

There is a need for continuous support of small-sized laboratories and university-based groups. In these stimulating environments young people are trained and new techniques are developed and tested before they move to the larger facilities and large-scale infrastructures.

#### a. Detector development

The development of detectors with better resolution and efficiency is crucial to experiments in this field.

#### b. Development work to improve the possibilities with particle traps

Particle traps are by now well established in fundamental physics research. Improvements and new developments will extend their applicability (e.g. with respect to polarised trapped samples), to increase the accuracy of results and address new observables.

### Priority 2. Theoretical support

Well-founded theoretical guidance and input is indispensable to select the best experimental options in view of the many technological possibilities that exist nowadays. Theory groups should therefore be supported and more theoreticians should be attracted to this field.

### Priority 3. Facilities

#### a. Precise QED studies with intense sources of low-energy antiprotons

Anti-matter research is exploring very basic principles, a main topic here being tests of CPT. Intense sources of low-energy antiprotons will boost this fascinating field with the potential for a large public outreach. They are indispensable for making progress in exotic atom spectroscopy and searches for new interactions such as anti-gravity.

#### b. Development work to improve the underground laboratories

Improved sensitivities for e.g. double  $\beta$  decay experiments, but also for other measurements requiring low



---

background, call for upgrades of the underground laboratories and potentially for new ones to be built.

**c. Upgraded and new facilities**

Research into fundamental interactions will benefit significantly from upgrades of existing infrastructure (e.g. HIE-ISOLDE, HITRAP) and new infrastructure (e.g. DESIR at SPIRAL, NUSTAR at FAIR and EURISOL). Other fields in nuclear physics share these interests. Many precision experiments cannot or only with difficulty be accommodated at existing facilities as they need regular access to beams or long continuous beam time periods. Therefore, dedicated new facilities providing such possibilities must also be supported. Examples are high intensity neutron sources, sources of coherent short wavelength electromagnetic radiation, and the ISOL@MYRRHA project. Finally, the ELENA ring and at a longer time scale the modules 4 and 5 of the FAIR project are of key importance to QED and antiproton research.



## 4. Scientific Themes

---

### 4.6 Nuclear Physics Tools and Applications

**Convener:** Sylvie Leray (Saclay)

José Benlliure (Santiago de Compostela),  
Andrew Boston (Liverpool),  
Marco Durante (Darmstadt),  
Santo Gammino (Catania),  
Joaquim Gomez Camacho (Sevilla),  
Mark Huyse (Leuven),  
Jan Kucera (Řež),  
Lembit Sihver (Göteborg),  
Christina Trautmann, (Darmstadt)

**NuPECC Steering Committee Member:**

Philippe Chomaz

**NuPECC Liaison:**

Eugenio Nappi

## 4.6 Nuclear Physics Tools and Applications

---

### 4.6.1 Introduction

From the beginning and all along its history, fundamental knowledge and technological developments in Nuclear Physics has stimulated and fertilized research and applications in a variety of other fields. The growing interest of these interdisciplinary research areas is boosted either by the relevance of the domain itself, or by new possibilities offered by recent developments of nuclear techniques and tools.

In this report, we try to review briefly the recent achievements and the current state of the art in all the domains of applications of Nuclear Physics, discuss the future perspectives, identify the strength and weaknesses of the different communities involved in these domains and formulate recommendations.

The report is divided according to the different domains of applications:

- Energy
- Life science
- Environmental and space applications
- Security
- Material science and applications to other domains
- Cultural heritage, arts and archaeology

with an additional section devoted to new frontiers in nuclear physics tools i.e. accelerators, detectors and electronics.

The last section summarises the main conclusions of the report and gives general recommendations for the future.

### 4.6.2 Nuclear Energy

#### Key Question

How can Nuclear Physics contribute to the sustainability and acceptability of nuclear energy generation?

#### Key Issues

- Accurate nuclear data for the design of new generation reactors
- Study and modeling of nuclear reactions involved in transmutation processes or new fuel cycles
- Modern Nuclear Physics tools (accelerators, detectors, modeling techniques,..) applied to the design and construction of next generation fission/fusion reactors and incineration factories

The discovery of fission in the late 30s represented the second major contribution to energy generation under human control after the combustion process. However, security issues together with proliferation problems and the concern on the disposal of waste resulted in extensive discussions questioning the interest of this source of energy in the 80s.

Nowadays, the amplification of the green house effect contributing to the global warming due to anthropogenic burning of fossil fuels, together with the important increase in energy demand expected during the next decades are changing the energy policies worldwide. A mixing of sustainable CO<sub>2</sub> free energies based on renewable sources but also on advanced nuclear energy generators seems to be an option to combat climate change. In this respect, inherently safe fission reactors, transmutation of minor actinides responsible for the main long-term radioactive hazard of today's fission reactors and the development of fusion technologies will certainly contribute to reach this aim by improving social acceptance of nuclear energy.

Fundamental Nuclear Physics research being responsible of the discovery of the energy-generation processes, fission and fusion, can still contribute improving the sustainability of these energy sources. Nuclear data relevant for the design of new generation fission reactors or future fusion reactors, high-power accelerators producing neutrons in some waste transmutation options constitutes examples of the role that fundamental nuclear physics can play in solving the energy generation problem. Moreover preserving and developing the required nuclear knowledge through education and research at European universities and institutes is an important goal to fulfil the worldwide energy policy.



## Advanced options for nuclear energy generation

### Next generation fission reactors

Next generation (Generation IV) fission reactors are being designed under the following criteria:

- Sustainability: long-term availability of systems and effective fuel utilization for worldwide energy production, minimization and management of nuclear waste in order to reduce the long-term stewardship burden.
- Economics: advantage over other energy sources, with a level of financial risk comparable to other energy projects.
- Safety and Reliability: inherently safe reactors with a reliability at least equal to the most reliable present reactors
- Proliferation resistance and physical protection against natural or human induced disasters.

Fast reactor concepts studied in the framework of GenIV Forum, as the already demonstrated Na-coolant technology, fulfill most of the requirements. On the longer term, reactors based on the thorium cycle could also prove to be of interest.

### Accelerator-driven systems for nuclear waste transmutation

In the 90s the transmutation of nuclear waste was proposed in dedicated sub-critical reactors assisted by high-power accelerators known as accelerator-driven systems (ADS). Since then, important efforts have been devoted for the conceptual design of such a device. Presently, projects like MYRRHA in Europe, are proposed to demonstrate the feasibility and transmutation capabilities of those systems.

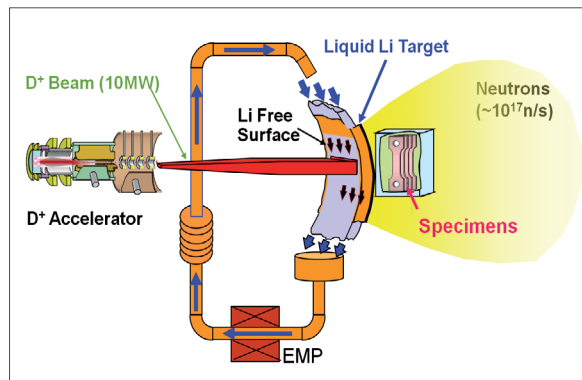

**Figure 1.** The IFMIF facility foreseen for testing materials for future fusion reactors.

### Fusion reactors

The fusion process, considered to provide sustainable energy of nuclear origin, recently received a definitive impulse with the construction of the next-generation research reactor ITER and the conceptual design of a dedicated facility, IFMIF, for investigating fusion material properties under extreme irradiation conditions. These two facilities together with the future industrial demonstrator DEMO define the roadmap for the magnetic confinement fusion technologies. Laser-driven inertial fusion will also be studied at LMJ in France and within the HiPER European project using the promising fast ignition approach.

### The role of nuclear physics

In the last decade Nuclear Physics has played decisive role in many relevant aspects related to the design of advanced options for nuclear energy. The most relevant contributions are the following:

#### Nuclear data and models

Accurate nuclear data and reaction models are of utmost importance not only for designing next-generation fission reactors, accelerator-driven systems or fusion reactors but also for extending the operation lifetime of present fission reactors. The main research programmes developed during the last decade in Europe are:

- precise measurements of capture and fission cross sections induced by fast neutrons on actinides and minor actinides of interest for fast reactors, the thorium fuel cycle or transmutation devices: differential measurements at facilities such as nTOF-CERN, GELINA or semi-integral experiments in thermal spectra (Mini-INCA at ILL).
- use of surrogate reactions for determining capture or fission reactions not accessible by direct methods (Bordeaux, Orsay, GANIL, ISOLDE)
- characterization of spallation reactions producing neutrons for transmutation in ADS (Jülich, Uppsala, Louvain-la-Neuve) in particular by measuring isotopic yields of spallation residues by the reverse kinematics technique at GSI.
- integral experiments for investigating the transmutation of nuclear waste in ADS like MUSE (Cadarache), MEGAPIE (PSI) and GUINEVERE (Mol).
- $\beta$ -decay studies of fission fragments related to the reactor heat problem (Jyväskylä)

Moreover, many research projects focusing on fundamental aspects of nuclear reactions and nuclear structure have an important impact on nuclear technologies or nuclear safety issues. For example they contribute to

## 4.6 Nuclear Physics Tools and Applications

develop more powerful and reliable models describing nuclear reactions, nuclear decays or the transport of particles in matter.

Those research programmes benefited from most of the existing European infrastructures for basic Nuclear Physics research while in some cases specific infrastructures were built such as the nTOF experiment at CERN. These projects also received a decisive support of some national funding agencies but in particular of the European Commission (FP5 HINDAS, n\_TOF, FP6 NUDATRA, MEGAPIE, EFNUDAT).

### Methods and tools developed by Nuclear Physics

Nuclear Physics have also transferred new methods and tools developed in the frame of basic research to nuclear technology research programmes. Some examples are:

- High-power accelerator technologies to be used in ADS, d-t sources for neutron physics research or advanced radiation detection systems.
- New measurement methods based on advanced digital electronics or performant trigger systems.
- Modern data analysis techniques using multi-variable techniques.

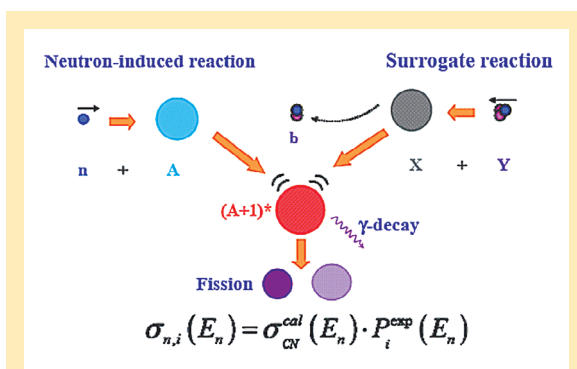

To study neutron induced reaction on targets difficult to produce or to handle because of their radioactivity, nuclear physicists use the so-called surrogate method. This method consists of producing the same compound nucleus  $(A+1)^*$  via another reaction, for instance a transfer reaction, and measuring the decay of the compound nucleus  $(A+1)^*$  in coincidence with the ejectile  $b$ . The neutron-induced cross section for the corresponding decay channel is then deduced from the product of the decay probability measured in the surrogate reaction and the compound nucleus cross section for the neutron-induced reaction. The latter cross section is obtained from optical model calculations.

### Education, training and know-how preservation

Most probably, one of the major contributions of Nuclear Physics to nuclear energy generation is the human capital trained in basic Nuclear Physics techniques that is transferred to nuclear industry or to governmental bodies linked to the different aspects of nuclear energy generation. Nuclear Physics guarantees an important fraction of the know-how required to develop advanced nuclear energy options.

### Future perspectives

The next decade will be crucial for the future of nuclear energy generation systems, therefore, the contribution of Nuclear Physics should be maintained if not increased. More accurate data on thermal neutron-induced reactions, in particular for major actinides, will help increasing the fuel burn-up and the life time of present reactors. The investigation of fast neutron-induced capture and fission reactions on actinides and minor actinides should be completed for designing next-generation fast fission reactors. The characterization of high-energy reactions, such as spallation processes, involved in accelerator-driven systems should also be accomplished. New data on the thorium-fuel cycle are also required to develop innovative options based on fission. The most important cross sections to be measured or re-evaluated have been listed by several expert committees (OECD-NEA). The European Commission has also guaranteed the support to these activities through the FP7 project ANDES.

Fusion will also require inputs from Nuclear Physics for ITER, HiPER and IFMIF. In both cases, activation data, material modification through nuclear reactions, neutron multiplication, in particular for tritium breeding ratio calculations, in  $(n,xn)$  reactions or hydrogen, tritium and helium production in neutron-induced reactions are of major importance. Emphasis should be put on measurements of threshold reactions and of angular distribution and energy spectra of emitted particles. However, while in ITER the necessary data concern reactions induced by neutrons up to 14 MeV, in the case of IFMIF the upper limit is 50 MeV and data on deuteron and proton-induced reactions are also needed.

These activities will strongly depend on the available infrastructures for performing the above mentioned measurements. In particular the second phase of the nTOF experiment at CERN is expected to strongly contribute with the possibility of using radioactive samples as targets. Moreover, many projects will certainly benefit from next-generation Nuclear Physics facilities being built in Europe during the next years such as FAIR or SPIRAL2. NUSTAR experiments at FAIR will contrib-

---

ute to generate new knowledge on nuclear structure properties of interest for the nuclear energy generation problem (DESPEC or MATS) but also to investigate fission reactions for non stable actinides (R3B and Elise). The recently approved upgrade of ISOLDE, CERN will enable further studies of surrogate reactions using post-accelerated radioactive ion beams. The NFS experiment at SPIRAL2 is also expected to contribute to investigate reactions induced by neutrons.

## Recommendations

The mobilization of European nuclear physics with the strong support of EC during the last FPs has allowed the collection of new high-quality data and the development of more reliable nuclear reaction models that are used in nuclear data libraries or transport codes. In order that this effort benefits Europe:

- the resources on evaluation should be increased so that European measurements end up more rapidly into European libraries (JEFF3),
- work on nuclear reaction models, involving theoreticians, either in support to the evaluation process or for direct implementation into transport codes should be encouraged.

Relations between fundamental physicists, reactor physicists, evaluators and end-users should be improved in order to benefit from the complementarities between differential and integral data. It is important that nuclear physicists respond to the request of end-users and measure nuclear data that have been identified as top priorities. However, it should be kept in mind that the priority lists are generally established for specific cases and that other requests will emerge, for instance, when more precise GenIV reactor design will become available.

The increased involvement of fundamental nuclear physicists in nuclear data has been a chance for the domain since it has led to a renewal of the experimental techniques (for instance: new types of detectors for flux measurements, fast data acquisition systems...) and the development of innovative methods (use of surrogate reactions to access cross-sections on isotopes difficult to use as targets, reverse kinematics, coincidence experiments to constrain the reaction models, new methods for reactivity monitoring, sub-criticality determining ...). Further fundamental studies that provide access to nuclear data never measured, as complete isotopic yields of fission fragments, or bring a better insight into reaction mechanisms, for instance through exclusive measurements, should be encouraged.

Support to the small scale facilities and the installations at large scale facilities that are unique to provide high quality nuclear data essential for nuclear energy

applications should be guaranteed. This applies in particular to: n\_TOF at CERN with the construction of the short flight path, NFS at GANIL that will provide high neutron fluxes between 100 KeV and 40 MeV and therefore will be well suited for measuring nuclear data for fusion and fast reactors, FAIR R3B and ELISE which will allow detailed studies of fission and spallation reaction mechanisms.

At present, the expertise in the domain of target sample preparation and characterization, in particular for isotopically pure samples, is rapidly decreasing in Europe. The only exception is the recently approved project CACAO at the institut de Physique Nucleaire-ORSAY of a lab for fabrication of radioactive targets which should cover part of the future needs. In addition, the use and manipulation of radioactive targets is submitted to more and more severe regulations. This sometimes leads to large delays or even the impossibility of important measurements. A common European effort is necessary to solve this problem.

## 4.6.3 Life Sciences

### Key Questions

- What can Nuclear Physics bring in therapeutic applications?
- How can nuclear physics techniques improve diagnostics methods?
- What are the risks of low-level radioactivity?

### Key Issues

- New methods for producing radioisotopes for medicine, new isotopes
- Assessment of the benefits of hadron-therapy
- Improvement of the quality of imaging technologies decreasing the dose to the patient
- Development of radiobiology studies

Ionizing radiation and radioisotopes were applied to medicine shortly after their discovery at the end of the XIX century. The applications of nuclear physics tools to life sciences are today so many that it is impossible to summarize them in a short report. Nuclear physics tools are widely used in medicine, both in diagnostics and in therapy. Nuclear medicine is indeed well established branch of medical sciences. Radioisotopes (for therapy or imaging), X-rays (for therapy or imaging), and high-energy charged particles (in therapy) are essential tools these days. Some of the most employed imaging techniques are based on the detection of gamma

## 4.6 Nuclear Physics Tools and Applications

rays originating from injected  $\gamma$ -emitting radioisotopes in single-photon emission computerized tomography (SPECT) or from the annihilation of the positron from a  $\beta^+$ -emitter in positron emission tomography (PET), although non-radioactive methods (such as nuclear magnetic resonance) are also very common. Applications of nuclear sciences to biology and other fields of life sciences are also extensive. Radiobiology and radioprotection are very well established scientific disciplines.

### Radioisotopes

Radiopharmaceutical production is one of the key features in the next decade even if we simply consider the needs for SPECT imaging. The lack in the future of neutron sources from reactors will result in a reduction of the production of radioisotopes as  $^{99m}\text{Tc}$ ,  $^{123}\text{I}$ ,  $^{122}\text{I}$  etc. It is necessary to develop new production methods for emerging radioisotopes such as  $^{64}\text{Cu}$ ,  $^{94m}\text{Tc}$ , and  $^{124}\text{I}$  (using medium and low energy cyclotrons) and radionuclide generator systems for PET studies ( $^{68}\text{Ge}/^{68}\text{Ga}$  and  $^{82}\text{Sr}/^{82}\text{Rb}$ ), including development of radiochemical processes for separation of the radionuclides from irradiated targets, development of technology for the production of radionuclide generator systems and development of appropriate quality assurance and quality control techniques for the PET radiotracers. Among the short-lived radioisotopes used in therapy,  $^{90}\text{Y}$  and  $^{188}\text{Re}$  are attracting great interest, and they should be produced in situ using radioisotope generators.

Current hot topics in radioisotope production and use include:

- $^{99}\text{Mo}/^{99m}\text{Tc}$  supply and alternative methods for  $^{99}\text{Mo}$  production;
- innovative  $\beta^+$  emitters for PET imaging;
- metal radionuclides for PET imaging;
- $\alpha$ ,  $\beta$ , and conversion-electron emitting radioisotopes for systemic therapy;
- therapy using radioisotopes coupled to antibodies and peptides;
- radiotracers in drug development;
- production of isotopes with high specific activity.

### Particle therapy

Besides radiotherapy with fast neutrons and boron neutron capture therapy (BNCT), the term “particle therapy” is today used mostly for ion beam therapy – i.e. therapy using protons or heavier ions, particularly carbon at energies between 200 and 400 MeV/n. According to the most recent survey of the Particle Therapy Cooperative Group, 25 new accelerator facilities dedicated to cancer therapy are in planning stage or under construction. The debate on the cost/benefit ratio for these facilities is ongoing,

and it is dependent on new technologies and on the success of hypofractionation regimes, which appear already very promising for treatment of lung cancer. The current clinical results, although on a limited sample, support the rationale of the therapy – i.e. that the improved dose distribution (for charged particles in general) and the radiobiological characteristics (for heavy ions) do lead to improved clinical results, especially for tumours localized in proximity of critical organs, or resistant to conventional treatments. Although in many cases clinical data are still not sufficient to draw firm conclusions on the cost effectiveness of this treatment modality, the lack of phase-III trials can only be solved building new facilities, and these new centres should offer the opportunity to use both protons and heavier ions.

In Europe, protontherapy is established in several centres and further ones are under construction. As regards therapy with carbon ions, a pilot project started at GSI in Germany in 1997 and the new hospital-based centres in Heidelberg and the forthcoming centres in Italy (CNAO), in France (ETOILE) and in Austria (Med-AUSTRON) will treat many patients in the future years. The main innovations compared to previous experience in USA and Japan are the active scanning system (as opposite to passive modulation), the use of a biophysical modeling in the treatment planning to account for the change in relative biological effectiveness (RBE), and the online PET scanning for monitoring of the dose during the treatment. Spot-scanning provides improved dose distributions, and reduces the production of secondary particles, particularly neutrons, which may lead to late side effects.

Most of the clinical experience with ions heavier than protons is relative to carbon, because for this particle the RBE is about 1 at the entrance channel, and can be as high as 3-4 in the Bragg peak. Ions much heavier than carbon are difficult to use for therapy, first because the nuclear fragmentation of the projectile unfavorably modifies the shape of the Bragg curves, and second because the LET is high already in the entrance channel. Oxygen ( $A=16$ ) may be used in special cases, e.g. for very hypoxic tumours. On the other hand, ions with  $2 < Z < 6$  could also have applications in therapy. The physical and radiobiological basis of the action of energetic charged particles suggest that protons can represent a technical improvement for conformal therapy, and heavy ions even a potential breakthrough for the treatment of radioresistant cancers (e.g. renal cell carcinoma, melanoma, glioblastoma).



## Imaging

Imaging systems can be grouped by the energy used to derive visual information (X-rays, positrons, photons or sound waves), the spatial resolution that is attained (macroscopic, mesoscopic or microscopic) or the type of information that is obtained (anatomical, physiological, cellular or molecular). Macroscopic imaging systems that provide anatomical and physiological information are now in widespread clinical and preclinical use: these systems include computed tomography (CT), magnetic resonance imaging (MRI) and ultrasound. By contrast, systems that obtain molecular information are just emerging, and only some are in clinical and preclinical use: these systems include positron-emission tomography (PET), single-photon-emission CT (SPECT), fluorescence reflectance imaging, fluorescence-mediated tomography (FMT), fibre-optic microscopy, optical frequency-domain imaging, bioluminescence imaging, laser-scanning confocal microscopy and multiphoton microscopy.

Imaging technologies are rapidly evolving, and future perspectives include:

- monochromatic X-ray imaging;
- single photon counting CT;
- position-sensitive detectors for functional medical imaging;
- PET detectors with Time-Of-Flight capabilities;
- multi-modal scanners;

- fast image statistical reconstruction algorithms;
- nano-based devices for the realisation of 3D in-vivo dosimeters.

There is a general impression in the radiology community that MRI may soon become the primary diagnostic procedure. Recent years have seen impressive advances in the quality of the images that MRI produces, in part owing to the use of ever stronger magnetic fields (in which Nuclear Physics labs have a strong expertise, as shown by the design by Irfu of the ISEULT 11.7 Tesla magnet for NEUROSPIN). The challenge in this field is

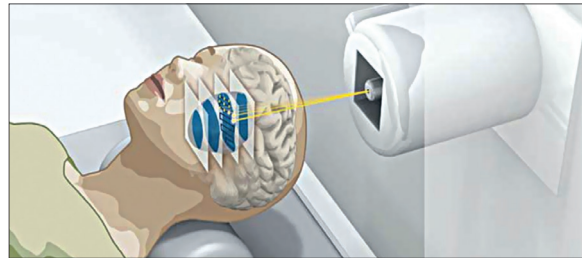

**Figure 2.** The principle of active scanning was originally introduced at GSI and is currently used both at PSI and HIT for treating tumours. The tumour is dissected in slices. Each iso-energy slice is covered by a net of pixels for which the number of particles has been calculated before. The beam is guided by the magnetic system in a raster-like pattern from pixel to pixel. The x-y plan is covered by magnetic scanning and the z-axis by energy variation.

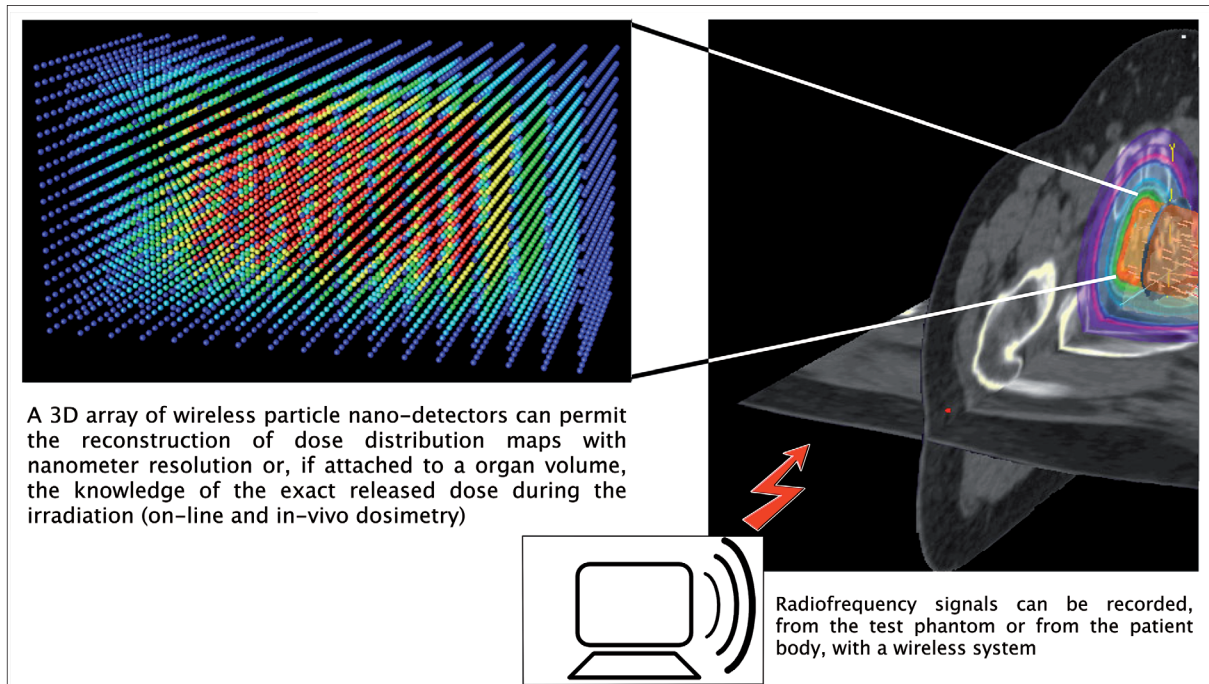

**Figure 3.**

## 4.6 Nuclear Physics Tools and Applications

---

to produce MRI scanners that are lightweight, open, portable and cheaper than the current bulky and claustrophobic cylindrical magnets.

### Radioprotection

In radioprotection, it is normally assumed that the risk of radiation-induced late effects is proportional to dose, even at very low doses (linear-no-threshold or LNT hypothesis). Recent results on non-targeted radiation effects may radically challenge the current LNT-based radioprotection paradigm. Non-targeted effects include:

- bystander effect: radiation effects in cells not directly exposed to radiation
- genomic instability: mutations and chromosomal rearrangements in daughter cells, many generations after the exposure
- abscopal effect: radiation effects in organs not exposed to the radiation field (observed in radiotherapy)
- systemic reactions: inflammation and tissue-level radiation damage
- hormesis: low doses of radiation protect cells from subsequent high dose exposures.

These effects could potentially prove that our current risk estimates at low doses are either underestimated (e.g. if the bystander effect increase the risk in non-hit cells) or overestimated (if hormesis proves to be a relevant adaptive mechanism for ionizing radiation). The relevance of hormesis for radiation protection is highly debated, and the two conflicting recent reports from USA and French government advisory groups clearly demonstrates that more experiments are needed to clarify the mechanisms underlying these processes. Non-targeted effects could play a role not only in radiation protection, but also in radiation therapy (Figure 3). For radiation teletherapy (either by X-rays or charged particles), dose gradient-dependent responses may influence the effect. Tumour heterogeneity may also lead to non-linear responses within the treatment field and to longer-range, abscopal or systemic effects. For radionuclide approaches (such as those tagged to monoclonal antibodies), the signals from a few labeled cells may be amplified by bystander signals within tumours and may also have long-range, abscopal or systemic effects. Research in this field should be given high priority, using both X-rays and charged particles. The impact of this research in other fields is potentially very high especially in nuclear power plants safety and radiodiagnostic, but also in imaging technology in other fields (e.g. the use of body scanners in the airports), high-altitude flights and space exploration etc.

### The role of nuclear physics in the future

Numerous techniques and tools that have been borrowed to Nuclear Physics are now directly developed by the end-users or are commercially available (for instance cyclotrons for radiopharmaceutical production or protontherapy, PET devices ...). However, given the recent developments and the growing interest in the subjects described above, it is clear that fundamental Nuclear Physics has still an important role to play in health sciences. Examples are given in the following:

#### For radiopharmaceutical production:

- The production of novel radioisotopes implies study of reaction cross sections with proton beams or on neutron beams produced by light ions reactions, development of production techniques with for instance targets sustaining high-intensities, new radiochemistry schemes....
- The much higher sensitivity of Accelerator Mass Spectrometry (AMS) for  $^{14}\text{C}$  detection compared to conventional techniques permits a new approach in the research of new pharmaceuticals, for instance to study their metabolism and kinetics. These studies can be carried out with such small quantities of substances labelled with  $^{14}\text{C}$  (microdosing) that no pharmacological effect is detected, providing new information about the metabolism of pharmaceuticals particularly at a very early stage or allowing the test of several substances simultaneously. The use of a new generation of compact AMS systems dedicated to biomedical applications allows high sample throughput in short measurement times and with a precise yet simple measurement device.

#### For particle therapy:

- Nuclear physics can contribute to improving codes used in treatment planning system especially with further measurements of fragmentation cross-sections. Only around 50% of the carbon ions are eventually deposited in a deep tumour, the others undergo nuclear fragmentation. Therefore, accurate cross-sections are necessary to calculate the dose-deposition patterns. Most of the uncertainty is however related to the RBE, and therefore research in the field of radiobiology of energetic charged particles is urgently needed to improve cancer therapy and assess late effects. These research should be based at accelerators. In Europe, GSI (Darmstadt, Germany), GANIL (Caen, France), KVI (Groningen, The Netherlands), and TSL (Uppsala, Sweden) have important experimental programmes in the field of particle radiobiology. Several experiments are also carried out in many other accelerator facilities, as well

---

as in clinical particle facilities currently running (HIT and PSI) or planned.

- Further technological improvements include the treatment of moving organs with scanning beams, the use of rotating gantries for optimizing the treatment with minimal disturbance of the patient, and the development of compact cyclotrons to replace the current large and expensive synchrotrons in heavy ion therapy.
- In addition, the new technology of laser-acceleration of charged particles is a potential breakthrough in the field, as it could dramatically reduce the costs of the facilities, although their potential for practical applications is still to be demonstrated.

#### **For imaging:**

- The nuclear physics community tackles the problems of on-line Dose Monitoring and of performing accurate Quality Assurance tests by developing novel imaging modalities related to dose deposition and allow assessing the treated volume and deriving reliable indicators of the delivered dose. It concentrates on the detection of nuclear reaction products produced by the interaction of the beam with atomic nuclei of the tissue (positron emitting nuclides for ibPET (in beam PET), photons or light charged particles for ibSPECT (in-beam Spect)). The application of TOF techniques with superior time resolution to beam delivery integrated double head ibPET scanners has the potential for improving ibPET image quality. Furthermore, the real-time observation of the dose delivery process will become feasible for the first time, substantially reducing intervention times in case of treatment mistakes or incidents.
- Because each technology has unique strengths and limitations, platforms that combine several technologies (such as PET-CT, FMT-CT, FMT-MRI, SPECT-MRI and PET-MRI) are emerging, and these multimodal platforms have improved the reconstruction and visualization of data. Finally, in the future it can be foreseen that nuclear physics will meet nanotechnology: nanostructured devices are under study not only as vectors for therapeutical applications, but also for online in vivo dosimetry (Figure 3).

#### **For radioprotection:**

- The providing of still missing nuclear data for radiation protection at fusion facilities, future nuclear physics facilities (FAIR, ESS, EURISOL...), in space (see section 4.6.4)
- The use of nuclear physics techniques and tools in the growing field of radiobiology and the possibility to study the influence of a low background radiation environment on biological material at underground laboratories (as done for instance in Gran Sasso)

## **Recommendations**

Health science applications are very important for the society and, consequently, for the perception of Nuclear Physics by the general public. Therefore, the Nuclear Physics research and the facilities playing a role in this domain should be strongly supported, in particular the subjects listed above.

The health science domain requires and probably will require an increasing number of specialists in nuclear techniques, accelerators and simulation tools, and in particular of radiophysicists in hospitals. It is therefore important to train a lot of young people, who will easily find jobs in industry or in medical centres. The links between fundamental, applied research, medical centers and industry should be reinforced.

### **4.6.4 Environmental and Space Applications**

#### **Key Questions**

- How can Nuclear Physics help to understand and monitor climate evolution?
- How to monitor and predict radiation hazard in space?

#### **Key Issues**

- More compact Accelerator Mass Spectrometry (AMS) systems and more efficient sample preparation techniques for improved data sets of long-lived radionuclides in nature
- Portable highly sensitive detector systems for ionizing radiation
- nuclear power sources for satellites and space crafts
- Accurate nuclear reactions models

In environmental sciences, Nuclear Physics play an important role through the measurements of isotopes, in particular with neutron activation analysis and AMS, which are very sensitive methods for detecting trace amounts of both radioactive and stable nuclides. Isotope measurements can be used for many environmental studies, including dating, tracing and source identification, as for instance for pollution control, water resource management, studies of paleoclimate, ocean circulation, CO<sub>2</sub> exchange between atmosphere and ocean... Some of the measurements need very low background conditions in order to identify traces of isotopes. In this context, underground laboratories built for fundamental

## 4.6 Nuclear Physics Tools and Applications

---

interaction studies offer an ideal environment. In the present context of concern about greenhouse effect and likely induced climate change, a lot of these studies are of particular interest.

With the future plans of manned Moon and Mars missions, the question of radiation hazards due to cosmic rays for astronauts is becoming a crucial issue. The development of accurate simulation tools for dose assessment and appropriate dosimeters is therefore needed.

### Climate evolution

Nuclear applications are powerful tools in understanding the drivers of climate change. Recreating past climate events through nuclear reconstruction is helping the scientists to estimate the effect of future developments. Measurements of non-radioactive and radioactive isotopes, in particular  $^{14}\text{C}$ , can be used to map increasing ocean temperatures and acidification, the age of the polar ices, as well as shifting ocean currents, which are growing threats for marine biodiversity and sustainability, as well as potent influences on weather and storm patterns. In recent years, the field of Accelerator Mass Spectrometry (AMS) has expanded significantly and enables measuring isotopic ratios of  $10^{-15}$  and below.

Another important development of the last years is the ability to analyze small sample sizes. Standard  $^{14}\text{C}$  analysis is usually done at mg sample sizes. With special effort, samples in the 100  $\mu\text{g}$  range can be prepared in the conventional way. In addition to the use of solid sample material (for  $^{14}\text{C}$ , graphite mixed with iron), direct feeding of the  $\text{CO}_2$  into the ion source allows to reduce the sample size down to a few  $\mu\text{g}$ . This opens up a whole range of new applications where the available amount of  $^{14}\text{C}$  is limited (e.g. aerosol studies or dating of glacier ice).

High sensitivity of AMS for determination of other long-lived cosmogenic radionuclides, such as  $^{10}\text{Be}$ ,  $^{26}\text{Al}$ ,  $^{36}\text{Cl}$ , etc. makes it possible to measure the erosion rates of rocks, deposition rates of ocean and lake sediments, the age of ice cores, the timing of glacial stages, etc. Thus, the determination of cosmogenic radionuclides, namely  $^{10}\text{Be}$  and  $^{26}\text{Al}$ , in selected compartments of the environment makes it possible to obtain more accurate data about climatic changes that have already happened in the past, which is the necessary prerequisite for testing of prediction models of future climatic changes. Moreover, the determination of  $^{10}\text{Be}$  and  $^{26}\text{Al}$  with AMS is used in quaternary geology for estimation of the age and origin of sediments and formations produced by Eolithic geologic processes and for assessment of the age of extraterrestrial samples, such as meteorites.

Useful paleoclimatic information may be derived from these archives both because the deposition is influenced by climate and because solar activity (which influences production) and solar radiance (which influences climate) are correlated. In recent years, emphasis has been put on the development and application of AMS techniques for the measurement of heavier long-lived isotopes, including  $^{60}\text{Fe}$ ,  $^{99}\text{Tc}$ ,  $^{129}\text{I}$ ,  $^{236}\text{U}$  and other actinide isotopes. AMS combines ultra low detection limits and the possibility to analyze isotope ratios that can be difficult with traditional techniques. This led to widespread applications ranging from nuclear astrophysics (see section 4.4) to humanities and biomedicine. In particular, the use of AMS in environmental sciences is expected to expand further in the foreseeable future with long-lived cosmogenic radioactive nuclides contributing to a large body of knowledge on processes involving atmosphere, oceans, ice sheets, biosphere, soils and sediments.

Studies of the solar activity, to understand its relation to climate changes on earth, can in addition to using AMS, e.g. be performed by measuring the number of solar flares and Coronal Mass Ejections (CME) using detectors sensitive to ionizing radiation.

### Water and food management

The management and preservation of water resources is obviously a key issue for the world in the future. Isotope methods are used, for instance, for mapping renewable and non-renewable groundwater resources and gaining an improved understanding of the water cycle. An important programme is devoted to these subjects by IAEA.

The causes for soil degradation can be detected using environmental nuclide tracers. Radioactive isotopes can then be used to assess land use practices and soil conservation measures. This analysis helps in managing soil remediation. Food security is compromised by climate change. Nuclear techniques can help increase crop yields and nutrition. Plant breeding using mutation techniques produces crop varieties that can thrive under difficult conditions by adapting to drought and higher salt levels and a wider range of temperatures. The changing climate allows diseases and insect populations that afflict herds, destroy ripening crops or infest stored foods to migrate to new regions.

Nuclear applications, e.g. different sterilization techniques, using ionizing radiation, might help control trans-boundary animal diseases, as well as control pests and food-borne microbes.



---

## Assessing radiation hazard in space

Astronauts aboard Low Earth Orbit (LEO) spacecraft such as the NASA Space Shuttle and the International Space Station (ISS) or aboard a spacecraft traveling outside the Earth's protective magnetosphere on missions to and from the Moon or Mars are exposed to a radiation environment very different from the one on Earth. There is cosmic radiation from 1) Galactic Cosmic Rays (GCRs), which originate outside the solar system, and 2) energetic and transient Solar Particle Events (SPEs), which are emitted by the sun. The composition and energy spectra of the radiation from these two sources are quite specific and must be considered separately. In addition, trapped protons and electrons contribute to the dose in LEO. The levels of ionizing radiation in deep space are far in excess to levels on the ground and the crew member would be exposed to GCRs at a dose rate of  $\approx 1$  mSv/day, compared to an average  $\approx 10$   $\mu$ Sv/day on Earth. In addition to that, SPEs ranging from less than an hour to several weeks can cause lethal dose rates hundred times higher than the GCRs. The unshielded equivalent dose rate on Mars ranges between 100 and 200 mSv/year, depending on the Solar cycle and altitude, and can reach values as high as 300 - 400 mSv/year on the Moon. It has been estimated that personal on a mission to Mars might receive a total effective dose of more than 1 Sv.

Due to the harsh radiation environment in space, it is necessary to accurately estimate the biological effect of the radiation on the personnel on space mission, to certify that the radiation risks is below ethically accepted levels, and to be able to develop different countermeasures. Although GCRs are composed mostly of protons and helium with only 1% of heavier ions, the equivalent dose received by space crews is mainly due to the heavy ions. This means that the simulation tools used to assess radiation doses should include accurate nuclear models for reactions induced by all types of particles from proton to iron.

Another matter of concern in space is the occurrence of single-event effects (SEE) in semiconductor electronic components and systems due to particles that travel through a semiconductor. The induced ionization may cause a bit flip in a memory or a register or a destructive latchup. Single event effects are of growing importance for electronics in satellites, and also in aircraft, due to the increased miniaturization.

## Recommendations

Europe has a highly developed knowledge of nuclear physics and its different applications, but the knowledge transfer to younger generations might be a potential problem in the near future since the interest for nuclear technology had decreased over the last 20 years. However, the recent strong interest for climate related research, green energy and new forms of radiation therapy, e.g. heavy ion therapy, might trigger new cross-disciplinary areas of importance for environmental applications of nuclear tools. The future plans for manned Moon and interplanetary space missions are also increasing the interest for space related research. The widespread use of AMS requires highly trained personnel for the operation of the accelerators also in non-physics laboratories.

The measurement methods and models to predict the environmental impact of different human activities must be improved. This include development of more sensitive portable detector systems to be able to measure low levels of ionizing radiation from radioactive tracers, naturally occurring radioisotopes, etc., which could e.g. be used to map of the historical thickness of the polar ices, as well as shifting ocean currents.

While there is a growing number of AMS facilities, mainly due to the advent of more compact systems, there should be at least one large tandem accelerator ( $> 10$  MV) available for AMS where radionuclides with isobaric interference in the mid- and high-mass range (e.g.  $^{60}\text{Fe}$ ) can be measured.

Better identification of other factors, than listed above, that determine Earth's climate and eco balance, e.g. amount of rain forests, release of other pollutants than green house gases, depletion of natural resources, and improve our understanding of the environmental impact of changes of these factors. The global effect of these factors can also made by continuous monitoring from space by e.g. of using nuclear powered satellites, measurements of naturally occurring radioisotopes, etc.

Accurate simulation codes, to be used for radiation risk estimation in space must be developed. This implies measuring relevant nuclear data (light-ion induced reactions) and developing reliable nuclear reaction models. Appropriate detectors should also be developed. Especially there is a strong need for development of early warning systems for high energetic SPE's for space craft on interplanetary missions.

The development and use of nuclear power in space would enable the human race to extend it visions into regions otherwise not accessible. This concerns for instance missions to the outer planets in a our solar system, which have a poorly lit environment, or missions close to the sun, The long lunar nights ( $\sim 14$  Earth days)

## 4.6 Nuclear Physics Tools and Applications

will also create a mayor penalty for solar powered systems, etc. The frigid, dimly lit polar regions of Mars are another potential difficult location in which to operate non nuclear power sources for long periods of time.

To be able to fulfill the above listed goals, it is important to support cross-disciplinary projects, e.g. nuclear/radiation physics/chemistry and climate research, ecology, meteorology, etc.

### 4.6.5 Security

#### Key Questions

- Which new, or modifications of existing Nuclear Physics tools are needed to cope with new requirements regarding homeland security?
- Can neutrinos be used as a probe for non-proliferation control?

#### Key issues

- Portable highly sensitive detector systems for ionizing radiation.
- An improved high intensity neutron generator
- Requirement for  $\beta$ -emitter decay data for non-proliferation control
- Smaller and improved Accelerator Mass Spectrometry (AMS) systems

Research in nuclear physics has led to better methods for detecting radiation from both natural and manmade sources, which is increasingly important for maintaining national security and monitoring environmental change. Nuclear Physics instrumentation systems have a key role to play in improving the systems used in threat reduction and nuclear forensics applications. Nuclear physics can also make significant contributions to improve the quality of nuclear data which is necessary within this subgroup for use in synthetic Monte Carlo simulations of various threat scenarios, including the detection of concealed fissionable material.

**Passive and Active sensor systems:** Threat reduction systems utilising both active and passive systems have a huge role to play in the fight against global terrorism. Active systems stimulate the emission of radiation, usually through the injection of neutrons or photons of a given energy into the sample to be screened. Improved nuclear data on delayed neutrons and gammas for active neutron/photon interrogation is required to improve the accuracy of the information determined using this methodology. Passive systems rely on the detection of the radiation emitted by a particular sample.

### Detecting the 'atomic fingerprint' of explosives

Airports and other ports of entry urgently need a commercially viable way of rapidly identifying explosives or concealed fissionable material without the need to investigate by hand. The X-ray technology currently used to screen hold luggage is chemically blind; it can identify organic substances but cannot unambiguously discriminate between harmless substances and potentially harmful ones (like Semtex).

In principle, technology based on neutron bombardment would overcome this problem by identifying the elemental composition of items packed in hold luggage; these could then be compared to a database of 90,000 nuclides allowing the unique identification of the substance.

A number of Nuclear Physics groups have been funded to look at developing such a system in order to perform the basic research required to translate this idea into viable technology. An example is the Distinguish project funded in the UK in which a prototype is nearing completion and will soon be tested using real explosives.

The challenges in improving such a system will be to develop an improved high intensity neutron generator capable of delivering mono energetic neutrons cost effectively. Such projects will also want to consider improved spectroscopic gamma-ray scintillators such as  $\text{LaBr}_3$  devices whose development has so far been driven by the nuclear and medical physics communities. The development of improved non flammable neutron scintillators with digital neutron/gamma separation will also offer significant improvements in system functionality.

### Portal Monitors

Large area passive radiation sensors are required for installation at ports of entry or remote deployment to monitor vehicle traffic. Ideally these systems should be capable of making decisions on the level of threat posed by a vehicle on a very short timescale to allow for the routine flow of traffic. Existing systems require a vehicle to stop or travel slowly through a radiation sensor array. Nuclear Physics can contribute offering higher sensitivity spectroscopy capable sensors which offer a radiation imaging capability. Systems are being developed that utilize either a coded aperture or Compton camera collimation methodology to identify the location of radiation coupling this with optical images to allow rapid threat identification. These systems are however in their infancy and large opportunities exist to make significant improvements.

## Portable gamma ray spectrometer

Many radioactive isotopes emit gamma radiation. A number of the isotopes that are of interest for security are gamma ray emitters and so they can be identified through the spectroscopic measurement of the gamma rays they emit. A spectroscopic detector that can also provide an image of the source (its size and distribution for example) would be invaluable in detecting the illicit movement of radioactive material. There is huge demand for a system capable of categorization and identification of radionuclides as Special Nuclear Material (SNM) (i.e. Plutonium, Highly Enriched Uranium and Neptunium) or suspicious radionuclides that may be associated with SNM (for instance  $^{232}\text{U}$ ,  $^{238}\text{U}$ ,  $^{241}\text{Am}$ ) but also of radioactive isotopes used in medicine and industry, and of naturally occurring radioactive material.

There is the opportunity for the Nuclear Physics community to make a large contribution to this requirement. Systems built from medium energy resolution material such as cadmium zinc telluride (CZT) and  $\text{LaBr}_3$  can be responsive to incident gamma radiation of an energy range up to 3MeV. An example of such a project in the UK is ProGAMRayS which has developed a portable gamma ray spectrometer with radiation detectors made from cadmium zinc telluride (CZT), which can function at ambient temperatures. CZT's spectral response was enhanced using charge correction algorithms informed by pulse shape analysis techniques developed to track the movement of gamma ray interactions through germanium detectors (from the nuclear physics flagship Advanced Gamma Tracking Array – AGATA project) with millimeter precision. This system can produce spectroscopic images that can both determine the isotopes present and their location.

Systems capable of higher energy resolution performance based on cryogenic highly segmented germanium sensors are also being developed. These systems utilize electronic collimation using the Compton Camera principle to offer significant advances in the imaging sensitivity over existing instruments, allowing the identification of weak or concealed radiation signatures.

## Reactor neutrino detection for nuclear reactor survey

Reactor neutrino detection can be applied to monitor the operational status, power levels and fissile content of a nuclear reactor in real time with simple detectors at distances of a few tens of meters. A worldwide effort is underway to improve the prediction on antineutrinos emitted by the reactor and the ease of deployment and operation of the detectors. In France, the Double Chooz collaboration (working on neutrino oscillations) plans to use their near detector for a precision nonproliferation measurement. Since the Double Chooz near detector design is too complex and costly for widespread safeguard use, part of the Double Chooz collaboration decided to apply their experience to the development of a small, compact and simple detector dedicated to reactor safeguards: Nucifer. The design of such a small neutrino detector (~ 1 ton of Gd doped liquid scintillator) has been focused on maintaining high detection efficiency (~ 50%), good energy resolution and background rejection. The goal is to have sufficient sensitivity to detect illicit retrieval of Pu from the core. The final detector will be tested at two research reactors and finally validated at a nuclear power plant. The Nucifer project and preliminary sensitivity studies have been presented to the International Atomic Energy Agency (IAEA) which has expressed its interest in the potentialities of this detector as a new safeguards tool.

In parallel, efforts are done to develop precise simulations of the antineutrinos emitted from a nuclear reactor. The final precision on the prediction of antineutrinos

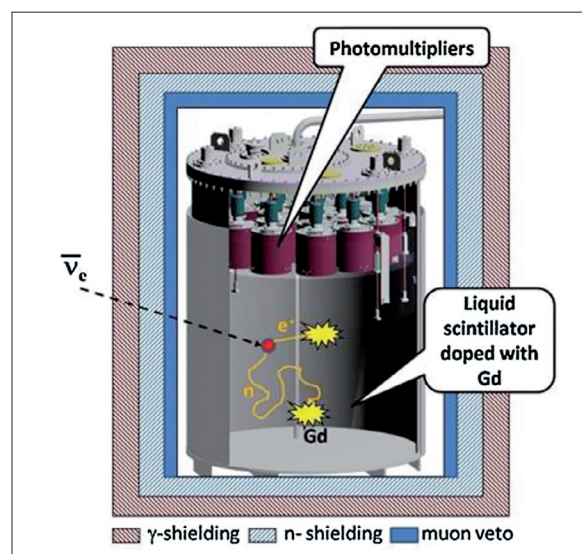

Figure 4. Scheme of the Nucifer detector with its shielding for reactor neutrino monitoring.

## 4.6 Nuclear Physics Tools and Applications

---

depends on the accuracy with which the inventory of fissile isotopes, fission product yields and  $\beta$ -decay of exotic fission products are calculated or given in nuclear data libraries.

### Accelerator Mass Spectrometry

Accelerator mass spectrometry (AMS) provides a very useful tool for characterization of actinides (namely uranium and plutonium isotopes) on the level of so called “fingerprints” in quantities significantly lower than by other methods. This makes it possible to identify the origin of such materials even at ultratrace quantities of nuclear materials that may be spread from the declared or, namely, from the non-declared nuclear facilities and illicit trafficking. Moreover, AMS is used in the study of behaviour of actinides in the environment which allows to follow the fate of actinides at the current minute levels that are mainly distributed by the global fall-out from the tests of nuclear weapons in the atmosphere that took place in the fifties and sixties of the last century as well as from the Chernobyl accident. Such research contributes to improving the models of the actinide and fission product behaviour and distribution in case of any accidents in nuclear facilities. This will also contribute to a better reliability of the respective safety studies.

### Recommendations

A large amount of experience exists in the European nations in competences which have direct relevance to security applications. The nuclear sector has a key role to play. In particular, the instruments and techniques developed for fundamental nuclear physics studies offer huge opportunities for knowledge transfer to the security sector. There are many examples of successful projects exploiting technology developed for fundamental nuclear science. However, we need to work harder to ensure that it is recognized that blue-skies research and development spawns novel ideas and technologies. Further mechanisms need to be established that encourage knowledge exchange between the academic nuclear community and industry.

The nuclear physics and engineering institutions train the next generation of expertise in applications areas allied to nuclear science. Mechanisms need to be established to protect the investment in training the younger generation through graduated and post graduate programmes.

### 4.6.6 Applications in Material Science and Other Fundamental Domains

#### Key Questions

- How do materials behave under extreme conditions?
- Can we understand interatomic interactions (e.g. bond formation) at extremely short time scales?
- Can nuclear physics help to visualize dynamics of ion-beam processes where other techniques fail?

#### Key Issues

- Understanding and characterization of material properties
- Controlled modification and nanostructuring of materials

The availability of accelerator facilities, originally developed for the nuclear physics community, has triggered the interest and the applications in a broad range of scientific and industrial areas. Today specifically adapted facilities are routinely using neutrons, x-rays, and ions for material characterization and modification. The following section mainly concentrates on ion beams as showcase of the on-going symbiosis between nuclear physics and material science. Improved irradiation conditions including ion beams of all elements (stable as well as radioactive from hydrogen up to uranium and also cluster projectiles such as C60 fullerenes) and advanced detection techniques have created new opportunities. Nowadays, ions with energies between keV up to hundreds of GeV are used in materials science, nanotechnology, planetary and geosciences, plasma physics, environmental research, and biology, just to name few examples. The applications include material analysis, radioisotopes as probes in solid state physics, testing the radiation hardness of materials in high dose environment, fabrication of nanostructures with microbeams, and targeting living biocells with single swift heavy ions. In particular in Europe, the broad utilization of ion beams in non-nuclear fields has reached high standards and international recognition with excellent scientific and technological perspectives.



## Ion beam analysis and modification with low-energy beams (< MeV)

The bombardment of materials with ions can be used for the characterization of structure properties such as the dimensionality, ordering, occurrence of defects, and for the analysis of electrical, magnetic and optical functionalities. Static as well as dynamical properties can be investigated. Furthermore, those properties can be controlled or modified by ion implantation. Layers can be grown leading to new properties at interfaces and surfaces, hybrid materials can be designed showing e.g. magnetic and superconducting properties, and by modifying the dimensions and the structure order parameters can be coupled. The study objects can be bulk material, thin films, surfaces, interfaces and nanostructures of many different materials (metals, semiconductors, and ceramics, polymers and many other insulators). Two different approaches can be distinguished:

### • Using radioactive ions:

- Through the hyperfine interaction, the radiation emitted in the decay yields information of the direct surrounding of the decaying nucleus.
- Dynamical properties, e.g. diffusion processes, are studied by recording the decay of implanted radioactivity

- In emission channeling, the direction of the emitted radiation is sensitive to the crystal structure of the sample and to the position of the probe atom in this structure.

The depth and lateral dopant profile can be accurately controlled through the ion energy and the implant temperature, giving more flexibility than thermal diffusion. Furthermore, these radioactive methods are extremely sensitive and therefore the dose can be strongly reduced, avoiding structural changes in the material under investigation due to the implantation dose. Both characteristics make these methods well adapted for the ever-decreasing dimensions of devices. Long-living isotopes can be used but the availability of suitable probes is rather limited. Nowadays these studies are mostly performed at ISOL facilities, such as ISOLDE CERN where beams of more than 800 different isotopes are available.

### • Using stable ions

- Nuclear reactions are used for depth profiling or to analyze light element concentrations.
- Proton induced x- and  $\gamma$ -ray emission is a non-destructive analysis method providing a detection limit as low as 100 ppm.
- Numerous other ion beam implantation and analysis techniques such as Rutherford Backscattering,

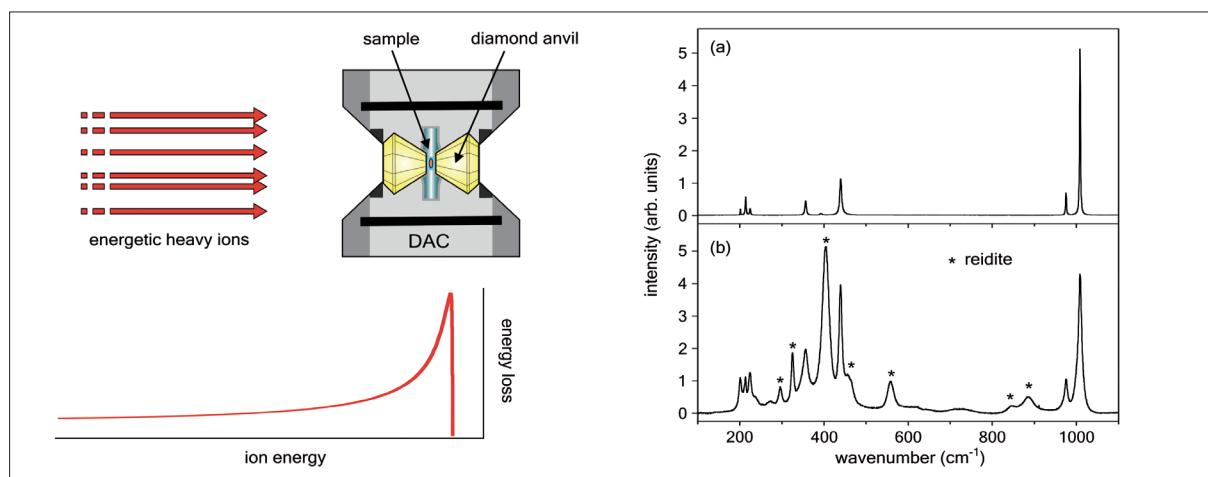

**Figure 5.** The combination of two extreme environments such as exposure to energetic ion beams and high pressure is able to significantly change the phase-transition behavior of solids. Samples pressurized between two diamond anvils up to several tens of GPa are irradiated with relativistic heavy ions of sufficient kinetic energy to pass through several mm of diamond. Such projectiles are only available at large accelerators facilities typically used for nuclear physics and deposit an enormous amount of energy into the sample. Simultaneous exposure to pressure and energetic flux may trigger quite different material responses such as long-range amorphization, decomposition into nanocrystals, or enhanced phase stability. The irradiation, for example of the mineral zircon pressurized to 18 GPa leads to the high-pressure phase reidite not induced by the applied pressure or energetic ions alone. Such studies are important for the basic understanding of radiation-induced phase changes and are of significance for geochronology and thermochronology, because they can simulate effects of fission fragments in the interior of the Earth. The left figure shows the scheme of ion beam exposure of sample compressed in a diamond anvil cell (DAC) together with the energy deposition of the ions along their path. On the right figure, the Raman spectra of zircon ( $\text{ZrSiO}_4$ ) exposed to  $5 \times 10^9$  ions/ $\text{cm}^2$  at (a) ambient pressure and (b) 18 GPa, respectively is displayed. Only the sample irradiated under pressure exhibits specific Raman bands (\*) indicating the creation of the high-pressure phase reidite.

## 4.6 Nuclear Physics Tools and Applications

---

Channeling, Ion Beam lithography yield specific material information.

- Future development should include AMS providing sensitivity of  $10^{-17}$  and high resolution elastic recoil detection analysis (HRERDA) at high energies ( $> 10$  MeV) allowing mapping of light elements with mono-atomic layer resolution.

The application of ion beam techniques does not require demanding beam energy and intensity conditions. Such experiments thus do not need elaborated radioprotection conditions. As a consequence, many universities and institutes have developed dedicated accelerators and infrastructure with specific auxiliary equipment. For various aspects, the users of the different specialized facilities would benefit from a Europe-wide network. The SPIRIT consortium is an excellent initiative integrating eleven European ion beam facilities in the energy range from  $\sim 10$  keV to  $\sim 100$  MeV.

### Material modification with high energy heavy ions (MeV–GeV)

#### Material structuring

During the last decade, developments in nanoscience and the related rapidly increasing activities have boosted the interest in nanostructures. Accelerator facilities provide excellent fabrication tools, e.g., by adjusting the structuring depth via beam energy, writing structures with microbeams, or placing individual ions at predefined positions. Nanotechnology based on ion tracks with MeV-GeV heavy ions produces nanopores in track-etched membranes applied as commercial filters, cell cultivation substrates, and templates for the synthesis of nanowires.

The capability of energetic ion projectiles created new opportunities by forming nanostructures of controlled dimensions allowing the exploitation of novel physical, chemical and biological properties of materials at nanometer scale. This promising trend should be further promoted providing suitable beams and warranting sufficiently frequent access to nuclear-physics dominated facilities.

#### Materials exposed to radiation

Characterization and performance control of material exposed to extreme radiation environments is of great importance for various fields.

- Future facilities such as SPIRAL2 (at GANIL, Caen, France), FAIR (at GSI, Darmstadt, Germany), EURISOL (Europe), ISOL@MYRRHA (Mol, Belgium) are designed to produce and deliver radioactive beams requiring pri-

mary beams of unprecedented intensities. Functional performance of target materials and components close to the beam line tube will face a considerable risk of failure either due to direct exposure or secondary radiation consisting of gammas, electrons, neutrons, protons, and heavier particles.

- The need for radiation-hard high-performing materials in extreme environments is also well documented for future fission reactors, advanced nuclear fusion fuels and waste forms. In all of these nuclear energy systems, the performance of materials under extreme conditions is a limiting factor particularly with respect to safety.
- In material science, one of the many challenges is understanding the response of solids when simultaneously exposed to several extreme conditions such as high pressure, temperature, and high-energy ion beams. Research in this field opens up strategies for novel materials by manipulating phase boundaries, stabilizing phases which are otherwise inaccessible, and providing new routes in phase diagrams.
- The combination of two extreme environments such as exposure to energetic ion beams (several hundred MeV per nucleon) and high pressure are of great interest in geosciences with respect to stability of planetary and geomaterials and for better understanding processes in the Earth's interior.

A fundamental understanding of materials under extreme conditions including control and prediction of functional performance will require the ability to relate phase stability and thermo-mechanical behavior to a first-principles comprehension of damage production as well as kinetics and interaction of defects. This is a complex and challenging problem with broad implications across science and technology, implying the following most urgent issues to be solved:

- **From medium to extreme dose regimes:**

The fundamental challenge is to understand and control thermo-mechanical, electrical, and other physical material phenomena from femto-seconds to millennia, at temperatures to  $1000^\circ\text{C}$ , and for radiation dominated by electronic excitation as well as elastic collision-induced defects up to extreme doses of hundreds of displacements per atom (dpa). Suitable procedures need to be developed that allow extrapolation and predictions of materials functionality under such extreme conditions based on tests in the dose regime reachable with existing beams. Test facilities, preferable on-site, are required to investigate properties and breakdown limits of highly activated samples.

---

- **Watch damage happen:**

Improvement of damage characterization is needed, including in particular in-situ observation of ion-beam produced defects as they originate and evolve on ultra-fast time scales.

- **Go beyond today's 'cook and look' approaches:**

At present, we lack a sufficient multi-scale understanding of component performance and failure to enable process-aware control of materials functionality. Central to this challenge is bridging first-principles atomic-scale understanding to integrated bulk phenomenology. Solutions require novel approaches for manipulation and control of defects and interfaces across multiple length and time scales. This transition from observation and validation of performance to the prediction and control of functionality has to be accelerated.

## Applications to plasma physics

When high-power ion beams deposit sufficiently large energy densities, solids stop being solids and become plasmas. Future challenges of plasma physics comprise generating and probing plasma conditions by heavy-ion heating in combination with intense lasers. Alternatively, interactions of heavy ions with plasmas targets produced by high power lasers (e.g., PHELIX) are of great interest. A key requirement for the successful use of these opportunities is the development of novel experimental methods and techniques.

## Recommendations

For future developments and to keep the European cutting-edge position in particular in materials science with high-energy ion beams, it is strongly recommended to closer interlink the existing complementary equipment and areas of specialization provided by the many facilities within Europe. Current network activities (e.g., ITS LEIF for activities using highly charged ions or SPIRIT for material analysis and modification with low-energy beams) demonstrate the benefits such as an increase of user access and quality of research by sharing best practice, balancing supply and demand, harmonizing procedures as well as by student education and training. Joint research efforts will also promote new emerging fields such as ion-beam analysis with ultrahigh depth resolution, ion-based tomography, or chemical and molecular imaging.

## 4.6.7 Cultural Heritage, Arts and Archaeology

### Key Question

- How to improve non-destructive in-depth elemental analysis?
- How to improve dating techniques?

### Key Issues

- New developments in IBA techniques
- Portable devices
- Higher precision radiocarbon measurements using AMS
- Improved communication between the different disciplines

Nuclear physics tools have become an essential tool for the study of the cultural heritage. The availability of different accelerator facilities all over Europe has allowed an extensive use of nuclear physics tools to obtain information of archaeological and artistic objects. The key aspect of nuclear physics tools regarding cultural heritage is the virtually non-destructive character of the techniques.

Ion Beam Analysis (IBA) techniques (often being complemented by X-ray fluorescence) and neutron activation provide information on elementary and isotopic composition of archaeological objects. The date of the samples is often obtained from the  $^{14}\text{C}$  content by means of Accelerator Mass Spectrometry (AMS). With the improvement in accelerator as well as detector technologies, these nuclear techniques experienced significant progress in the last years.

### IBA Techniques

In Europe, several low energy accelerators are operating but only two are particularly devoted to non destructive analysis in the Cultural Heritage field, AGLAE accelerator working at the Louvre museum and the LABEC tandem laboratory in Florence. Both are equipped with micro beams (elemental maps), external PIXE (Particle-Induced X-ray Emission) and PIGE (Particle-Induced Gamma-Ray Emission) apparatus, and high energy resolution detectors. Other small energy laboratories are partially involved in Cultural Heritage field. In general, their scientific potentiality may cover the largest part of the needs but it is essential to maintain a high level of R&D in these laboratories in order to be able to provide an up-to-date analysis to art specialists.

## 4.6 Nuclear Physics Tools and Applications

One problem of IBA techniques, in its application to paints, ceramics, or other multi-layer elements, is to disentangle the elementary composition of the different layers. This has been achieved by means of the Confocal PIXE technique, which relies on the accurate detection of X-rays using a polycapillary lens before the detector. This procedure increases the X-ray intensity associated to the layers corresponding to the focal plane of the lens, and thus allows determining the depth profile of samples. Confocal PIXE provides the possibility to resolve elemental distribution in separate layers in a complex structure. This technique is used in the Louvre accelerators in paintings, and also in the Franz-Josef Institute at Lublijana in ceramics. Further development of confocal PIXE, with improvements in the depth resolution, can be achieved improving the X-ray optics of the polycapillary fibers as well as the resolution of the cameras.

Another procedure to obtain information in depth is the use of Differential PIXE. This technique, which has been developed in LABEC (Florence), determines the PIXE spectra for different beam energies. The higher energies penetrate deeper in the pigments, and the corresponding PIXE spectra are more sensitive to the elemental composition of the deeper layers.

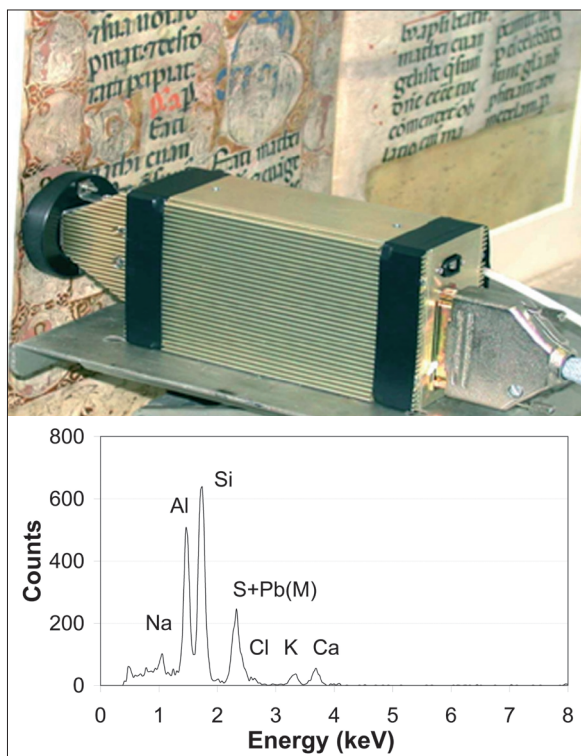

**Figure 6.** PIXE- $\alpha$  system ( $^{210}\text{Po}$ ) measuring a gold preparation in a Pontificale from Salerno; the x-ray spectrum features an efficient excitation of light elements.

Higher energy accelerators can also be used for the purpose of studies of the cultural heritage. At INFN-LNS (Catania) two external proton beam lines have been developed in order to perform analysis of the interior of the metals artefacts not perturbed by surface effects (Deep Proton Activation Analysis) using 20 MeV protons, and to perform a global analysis of the artefact using 60 MeV protons. At CNA (Sevilla, Spain) the 18 MeV external proton beam will be used to perform high energy PIXE, allowing in-depth analysis of higher-Z archaeological samples, exploiting the detection of their K X rays, which are produced with reasonably high cross sections at higher beam energy and at the same time not affected – owing to the higher photon energy - by self-absorption effects in the matrix itself.

Portable PIXE systems have been developed at LANDIS Laboratory of INFN-LNS, in collaboration with LNHB in CEA/Saclay. The PIXE- $\alpha$  system is based on the use of 1 mCi,  $^{210}\text{Po}$   $\alpha$  source, exciting well light elements but having a low sensitivity for medium atomic number elements. The XPIXE- $\alpha$  system uses both alpha particles and x-rays as exciting beams. The radioactive source is  $^{244}\text{Cm}$ . The new system permits to excite very well both light and medium atomic number elements.

### Neutron techniques

Neutron activation has some advantages over charged particles as an analytic technique, because neutrons can easily penetrate thick layers of sample, and because they present selective resonant absorption for specific elements. Thermal and epithermal beams are available at some European reactors. The ISIS neutron source of the Rutherford Appleton Laboratory produces pulsed neutron beams at different energies. In the last years the neutron beams have been used to perform analysis in the Cultural Heritage field. The aim of the FP6 European programme “Ancient Charm” is to investigate “Neutron Resonant Capture Imaging combined” with “Neutron Resonance Transmission” (NRCI/NRT) as a non-invasive technique for 3D tomographic imaging and its use in cultural heritage research.

### AMS Techniques

The by far most-used nuclide in AMS is  $^{14}\text{C}$ , which is extensively used for dating in archeology and cultural heritage, biomedical research and environmental studies. Nowadays, the availability of routine AMS dating provides archaeologists with an efficient tool which allows performing multiple datings of each archaeological site. There are presently about 25 AMS facilities in Europe providing  $^{14}\text{C}$  dating and several facilities are already being installed or are planned in the next few years.



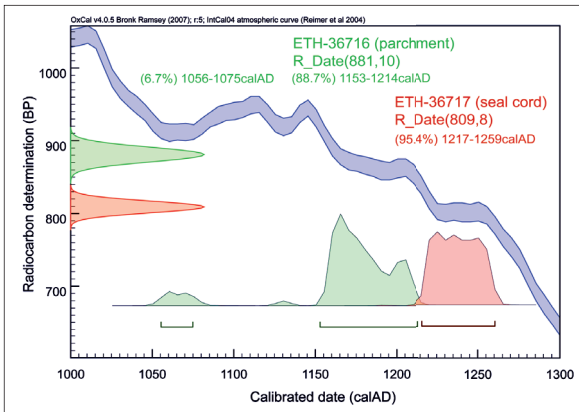
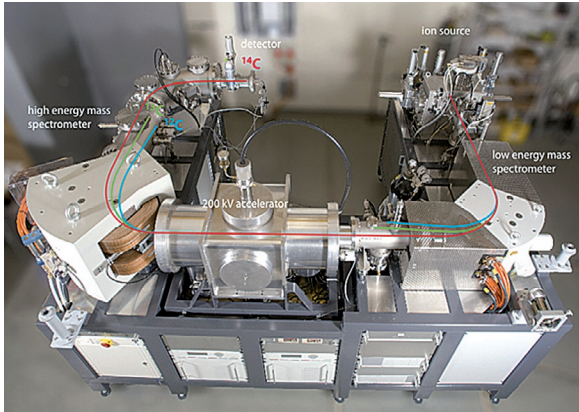

**Figure 7.** The new generation Accelerator Mass Spectrometry (AMS) system MICADAS developed at ETH Zurich is based on a 200 kV accelerator and allows routine measurements of  $^{14}\text{C}$  at a very compact facility. This concept of a compact and easy-to-tune AMS system is attractive to many areas where  $^{14}\text{C}$  measurements play a role ranging from routing  $^{14}\text{C}$  dating to biomedical and environmental applications. The excellent stability of the system allows also highest-precision  $^{14}\text{C}$  measurements

as it is demonstrated by the dating the parchment and the seal cord of the “Goldene Handfeste” of Berne, Switzerland. This document established the town privileges making it an Imperial Free City and, effectively, an independent state. Highest-precision  $^{14}\text{C}$  measurements can help to solve the ongoing controversy among scholars that the document might be a Bernese forgery from the middle of the 13<sup>th</sup> century.

In the past decade a new generation of AMS systems has been developed at ETH Zurich, which use multiple ion collisions to destroy molecular interference (as opposed to stripping to high charge states). This can be done at much lower energies (200 kV) resulting in a much simpler setup, reduced the overall size of the system and significantly less cost. These developments have allowed extending the number of laboratories that carry out  $^{14}\text{C}$  dating, and have increased strongly the impact of AMS in archaeology and other fields.

## Recommendations

A recent FP7 project called CHARISMA is devoted to the study and conservation of cultural heritage. Transnational Access is offered to complementary multi-technique advanced facilities available in large scale European installations and medium/small laboratories. Nuclear Techniques figure prominently in the project, through the participation of the C2RMF-AGLAE ion beam facility at the Palais du Louvre, the nuclear microprobe facility at ATOMKI-HAS, Debrecen, Hungary and the BNC, Budapest Neutron Centre, that will grant access to a dozen of instrumental neutron end stations. CHARISMA is a good example of the creation of a broad community in order to maximize the impact of the know-how available from the Nuclear Physics on the needs of the Cultural Heritage.

A European network of AMS facilities would be useful to transfer technology and training personnel. This is particularly important as more and more of the smaller AMS systems are being installed laboratories without experience in operating an accelerator-based system. Also, it could help to distribute the requests of  $^{14}\text{C}$  dating, optimizing the work load of different facilities.

Programmes to fund short time stays of young scientists and technicians in other laboratories, should be encouraged, especially in small accelerator centers. This will promote collaborations and exchange of skills.

Outreach material (leaflets, publications) should be produced, to provide information to archaeologists, curators, and other scientists and professionals dedicated to heritage, what they can expect from the use of nuclear techniques.

## 4.6 Nuclear Physics Tools and Applications

---

### 4.6.8 New Frontiers in Nuclear Physics Tools

#### Key Question

- What is needed for major advances in particle accelerator and radiation detectors technology?

#### Key Issues

- High-intensity accelerators for Accelerator Driven Subcritical Reactors (ADSRs), ISOL based facilities, and the European Spallation Sources (ESS)
- Laser acceleration techniques
- Radiation hard, fast detectors with low material budget

#### Accelerators

Compact Sources of monochromatic/coherent beams of X/γ rays are under study in many laboratories and the next accelerators will play a leading role in the applications to different fields, including nuclear industry, medical imaging, biology, etc.

#### High intensity accelerators

Various developments are under way in the field of accelerators of electrons, but the major developments in the field of Nuclear Physics will be related to the availability of production tools and accelerators for intense hadron beams, either for light and heavy ions. Additionally there is a wide variety of exciting developments in nuclear physics tools that may result effective in the application to other domains. As for the accelerators, major efforts are under way at ESS (European Spallation Source), GSI, GANIL and other laboratories in order to produce high power beams, for different uses. The production of high intensity beams at ESS will be devoted to material science and life science, but undoubtedly the availability of such beams will open new frontiers in the research, being a typical case for cross-fertilization of different fields. Moreover, the production of high intensity beams for Accelerator Driven Subcritical Reactors and for ISOL facilities, along with outstanding developments aimed to research in nuclear fusion (IFMIF), will permit to have instruments to provide a number of by-products, considering that the same facility may produce beams for Nuclear Physics in some beam lines, beam for hadron-therapy and biology on others, and maybe even isotopes and neutrons for applications.

The ability to produce intense beams with high quality will be one of the major assets for all the new accelerator

facility; the presence of beam halos will be detrimental and generate different critical problems of machine operations including severe radiation damages and activation. Reliability and reproducibility of each component, especially for the low energy part of the accelerator, will become more and more important, because of the complexity of the machines and the limitations to redundancy. In order to conjugate frontiers performances with the reliability typical of industrial installations, an outstanding work is needed in terms of materials choice and treatment, in particular for the MW beam power facilities.

The optimization of the beam available from the front-end is one of the most time-consuming R&D, in spite of the relatively small cost of these component with respect to the high energy ones. The European Spallation Source will be able to produce more than 5 MW of beam power, entering in an unknown domain of technological requirements. In the meantime at the EVEDA demonstrator the high intensity issues for the low energy part of the accelerator will be settled.

The investment on Accelerator Driven Subcritical Reactors studies will be a rewarding example of the above cited cross-fertilization: accelerators for > 600 MeV proton beams with multi-mA intensities may provide in principle high rates of Radioactive Beams (e.g. at the MYRRHA facility an Isotope Separator On-Line may be installed for Nuclear Physics research) and they may be complementary to the two Radioactive Beams facilities under construction at GSI (FAIR) and GANIL (SPIRAL2), which will represent the state-of-the art in this domain for the next future. Also, EURISOL with its 4 MW accelerator dedicated to the Nuclear Physics research may be the big challenge for the future; its feasibility has already been demonstrated by the Design Study. Accelerator technology improvements and studies for the target-ion source units shall be continued, in order to be ready for the construction, when funding will become available.

Different components for Nuclear Physics accelerators need further research efforts to comply with the request of the forthcoming machines, including fast cycling magnets, beam cooling devices, highly charged ion sources, high power targets, superconducting cavities. The use of new materials may help in this sense and a continuous feedback with industries is recommended. As example, Nb<sub>3</sub>Sn wires permit magnet operation at larger values than with NbTi, and high temperature superconductors (HTS) may carry large current density even in the presence of extremely high magnetic fields.

Conceptual design of high field solenoids (above 40T) have been proposed by using YBCO conductor and the improvements in this domain seem far from saturation.

The R&D of magnets for accelerators will be useful for different industrial and medical application, in particu-

---

lar for NMR applications, as resolution increases with magnetic field strength. Technological developments on superconducting cavities are now focused on new resonant cavity fabrication techniques and cost reduction. For lowering costs and simplifying the technology, it becomes mandatory to search for superconducting materials with a critical temperature ( $T_c$ ) higher than that of niobium. Among them in particular two materials are of interest:  $V_3Si$  that has an unusual high Residual Resistivity Ratio and  $Nb_3Sn$  already used for resonant accelerating structure prototypes. An appealing research direction consists of the investigation of the nanostructured multilayer deposition of niobium and tin or vanadium and silicon.

### Plasma-based accelerators

In spite of the increasing ability to produce high field superconducting magnets, high gradient RF cavities, and high current ion sources, there is some evidence that the future developments of accelerators will be slower than in the past, because of the increasing costs of the components, unless new tools become available.

The production of large electric fields in relativistic plasma waves is expected to change the outlook either for applications (possibly profiting from tabletop particle accelerators, especially for industry and medicine) and for Nuclear and High-Energy physics. In the case of Nuclear Physics, the huge costs of construction and installation of the facilities may be reduced by the availability of plasma-based accelerators able to accelerate intense bunches of self-trapped particles with gradients as high as 10-100 GeV/m. The possibility to obtain within few mm the same results that are now obtained in long accelerating sections will be a remarkable progress for Nuclear Physics.

Certainly many doubts remain about the ability to produce significant currents with adequate beam quality, because of the challenging characteristics of the plasmas, produced typically by high power density lasers. Nowadays they are poorly reproducible and subject to strong inhomogeneities, but the roadmap for new accelerators developments will be probably based on the research in this field. The possibility to change the accelerating field by changing the plasma characteristics seems to be an interesting tool to obtain a modulation of the acceleration throughout the different sections: it is in fact  $E(V/cm) \propto \sqrt{n_e(cm^{-3})}$ , then a variable gradient may be obtained by means of different focalization of the laser pulse and different plasma densities in the accelerator sections.

## Detectors

Recent progress in nuclear physics detectors is providing new opportunities in various domains of applications. Examples concerning the development of advanced gamma ray spectrometers, including gamma tracking, have been given in section 5 for security applications but are also promising in other domains, in particular medical imaging. As regards charged particle detection, striking progress was achieved in position sensitive detector technologies, based on a new generation of Micro-Pattern Gas Detectors (MPGD) and silicon pixel devices. A few particularly illustrative examples are given below, where the interplay between research teams and industry is stronger than ever.

### MPGD

Micromegas and GEM detectors, which established the concept of MPGD, have improved their performance level and generated several variants of gaseous detectors. Unprecedented spatial resolution, high rate capability, large sensitive area, good operational stability and radiation hardness were achieved. More coarse Macro-patterned detectors, e.g. Thick-GEMs (THGEM) or patterned resistive-plate devices, can also be derived, adapted to very large-area coverage with moderate spatial resolution. The design of the new micro-pattern devices appears suitable for industrial production. Moreover, the availability of highly integrated amplification and readout electronics allows for the design of gas-detector systems with channel densities comparable to that of modern silicon detectors. In addition, modern wafer post-processing allows for the integration of gas-amplification structures directly on top of a pixelized readout chip.

### Silicon detectors

#### • 3D silicon strip detectors

These structures consist of arrays of p- and n-type electrode columns that penetrate into the detector bulk, instead of being implanted on the wafer surface like in standard planar semiconductor detectors. As a consequence of this geometry, the depletion region grows laterally between the electrodes, and the electrons and holes created by ionizing radiation move parallel to the wafer surface when they are being collected. 3D detectors feature therefore very short collection times, which should counteract the charge trapping caused by high levels of radiation damage. They are now becoming commercially available and offer attractive perspectives for applications requiring fast and radiation hard position detectors such as X-Ray imaging or the high luminosity upgrade of the LHC.



## 4.6 Nuclear Physics Tools and Applications

---

- **Monolithic active pixel sensors**

Pushed by the digital revolution in light imaging, by the consumer electronics requirements and assisted by the ever increasing level of microelectronics integration, a new class of pixel detectors for single ionizing particle detection appeared late in the nineties, driven by the team in IReS-LEPSI in Strasbourg. Monolithic active pixel sensors in CMOS technology are non-standard solid state particle detectors for several key aspects, notably signals at the level of 1000 electron-hole pairs. Nevertheless, they offer significant advantages in terms of cost-efficiency of the production process, granularity, spatial resolution at the micron level and ultra-low material budget. The flexibility offered by the range of available design and architectures make monolithic active pixel sensors an appealing platform for tracking systems in experimental apparatus, for bio-medical applications and table-top applications and for beam monitoring.

The future of these devices is very promising, based on 3D integration technologies presently used by industry for commercial RAMs and cameras. They allow interconnecting stacked and thinned micro-circuits with through silicon vias (TSV) over their whole surface, with inter-TSV distances below 10 microns. This technology allows combining in a single device several interconnected integrated circuits (tiers), manufactured in different CMOS processes. Each circuit may be fabricated in a process optimal for a dedicated functionality (charge sensing, analog read-out, digital processing, etc.). Moreover, each individual pixel may be connected to a complex read-out chain distributed over several tiers. This high potential detector technique has emerged only recently but it is definitely the most promising approach to cutting edge applications of this decade.

- **Silicon Photomultipliers**

Silicon Photo-Multipliers (SiPMs hereafter) consist of an array of p-n junctions operated beyond the breakdown voltage, in a Geiger-Mueller regime, with typical gain of the order of  $10^6$  and on-cell integrated quenching mechanisms. The technology development is by now focused on the spectral response, the control of the dark count rate, the optical cross-talk and after-pulse, together with the improvement of the photon detection efficiency; however devices are by now commercially available and naturally bound to replace photo-multiplier tubes for most of the high-end applications.

SiPMs complement the family of existing sensors: with a cell density of about  $10^3/\text{mm}^2$ , areas up to  $3 \times 3 \text{ mm}^2$  and a single output node, they offer the possibility of measuring the intensity of the light field simply by counting the number of fired cells and feature a genuine photon number resolving capability even at room temperature. Moreover, with expected time resolution at the 100 ps

level, they open up new perspectives in TOF applications in NP, HEP and medical imaging. Key features of the SiPM are affected by temperature, notably the dark count rate, the gain and the photon detection efficiency. Nevertheless, they do represent the state of the art on low light detection. Several applications are being developed in calorimetry, in dosimetry, environmental science and medical imaging, notably for novel PET systems.

### Electronics

Electronic circuitry is currently under-going quite fundamental changes, which concern micro-circuits as well as FPGAs. Particularly remarkable progress on ASICs comes from Silicon-on-Insulator (SOI) and Si-Ge technologies, complemented with very promising perspectives with architectures using vertical interconnection techniques. FPGAs, on their side, open new standards for tomorrow's data acquisition systems exploiting their high speed serial channels.

Silicon-Germanium (Si-Ge) VLSI technologies are used in high-end and consumer electronics for their very wide bandwidth, also in the design of mixed-signal high-speed devices. Typical applications include cellular phones RF circuits and input preamplifiers of digital real-time oscilloscopes. However, Si-Ge processes also offer higher dynamic ranges compared with CMOS devices, they have good performance in cryogenics applications and are radiation-hard. These features make the Si-Ge technology very attractive for designing high-performance detector read-out.

Different from Si-Ge, the Silicon-on-Insulator CMOS processes are in their early stage even in the marketplace and few foundries offer limited access only to a restricted portfolio of processes. The SOI technologies allow the designers to fabricate CMOS circuits on a thin Si layer, insulated from the bulk of the wafer. The isolation of the electronics makes the SOI processes appealing for the design of monolithic active pixel sensors (MAPS) detectors. The processes offer the clear advantage to shield the pixels from the embedded electronics, opening the path to fully integrated, low power MAPS arrays. Other applications of interest are low noise and very low power analog read-out electronics.

The real disruption in the design of ASICs will come from vertical integration technologies (see section 4.6.2). They allow fabricating chips composed of two layers, or more, of active electronic components, integrated both vertically and horizontally. This achievement results from advanced and ultra high precision wafer thinning, high aspect ratio (depth/diameter) through silicon vias (TSV) fabrication and oxide or metal compression bonding. The 3D technology allows for a substantial increase of the complexity of the circuitry that can be fitted on a



---

single die by allowing bigger density of transistors per unit area, resulting for example in a decrease of access time to a cache memory in a computer system. The 3D approach also opens up new frontiers for detectors' and imagers' architectures (see section 4.6.2).

While still being in its birth stage, there is intense activity in this domain, which is perceived as the most promising among all possibilities towards future front-end electronics high performance standards for most applications.

Field Programmable Gate Arrays (FPGAs) have been introduced on the market in early 80s and since then they have changed the design of digital circuitry. Last generation FPGAs also offer high speed serial channels capable to transfer data streams at rates up to 10 Gbit/s. The abundance of logic resources makes it also possible to implement in the fabric soft processors, which emulate commercial products or offer brilliant, specific computing resources for ad hoc applications. Serial I/O and embedded computing will override the architectures based on parallel busses and centralized processors, by allowing the designers to perform sophisticated analysis in every node of the system, even on detector, connected each other by means of high speed links on copper or fiber.

## Recommendations

Europe has been able to stay on the forefront of research in accelerators and detectors and it seems highly probable that this ability may be maintained in the future. Anyway it is evident that top level facilities may be built only as collaborative efforts between the different States. Indeed the presence of different competences in the different national institutions permits a wider approach to scientific and technological problems.

- The proposed idea to create a common R&D platform for accelerators, born in the environment of Particle Physics, should be endorsed by the Nuclear Physics community, extending it also to R&D of detectors.
- Research on new materials for superconductors is to be continued, especially for high  $T_c$  superconductors for which the properties vary drastically with the number of defects.
- Reliability of the components is a major concern both for next generation accelerators and for detectors.
- Versatile ion sources adapted to the production of intense beams of highly charged ions are required.
- Beam dynamics studies may take advantage of the improved computational facilities.
- The availability and reliability of low noise and low power electronics should be more accessible.

## 4.6.9 Summary and Recommendations

In this report, we have outlined the role of Nuclear Physics in a large number of interdisciplinary fields and applications and shown that this role will still be very important in the future. Examples can be found in the domains of energy with the revival and likely expansion of nuclear energy in the future, the issue of nuclear waste management and the perspective of fusion on the longer term; nanotechnology, health sciences including the development of particle therapy and the necessity of finding new ways of producing radiopharmaceutical isotopes, space applications for future interplanetary missions, and security related applications. Nuclear techniques and tools are bringing new opportunities for instance in emerging imaging techniques in medical diagnostics and therapy. IBA techniques, including the use of higher-energy beams, provide new possibilities in material science. Recent sensitivity improvement of the AMS technique has, e.g., allowed new progress in nearly all the domains of applications especially for cultural heritage studies, radiopharmaceutical research, environmental and security applications. Underground laboratories may be used for measurements requiring very low background conditions. The field of high-intensity accelerators largely benefits from the synergies between studies for radioactive beam production, ADS (MYRRHA project), IFMIF, radiopharmaceutical isotope production, and ESS. Research on plasma-based accelerators could lead to the development of much more compact and cheaper machines allowing a larger spreading of nuclear analysis techniques and, for instance, of hadrontherapy. As regards detector development, progress in gamma ray detection, including gamma tracking, in position sensitive detector technology and in silicon photomultiplier offers new opportunities for various domains of applications.

At present, numerous applications need more accurate nuclear data (production cross-sections, characteristic of produced particles, nuclear structure data, fission or fragmentation of light-ions, etc...) and reaction models in order to complement European data libraries and/or transport or other computer codes. This concerns nuclear energy (fission and fusion), particle therapy, radioprotection, security and space applications. It is therefore necessary to measure the nuclear data requested by the end-users, perform more fundamental studies allowing a deep understanding of reaction mechanisms (for instance fission or fragmentation of light-ions), and develop reliable nuclear reaction models for implementation into transport codes. A substantial effort should be put on the evaluation process so that measurements can end up rapidly into European data

## 4.6 Nuclear Physics Tools and Applications

---

libraries. The relations between fundamental physicists and end-users (reactor physicists, medical physicists, engineers...) should be reinforced and clarified, for instance by establishing networks or organising regular meetings.

Measurement of nuclear data and research in materials science often requires targets or samples of high isotopic purity, which may be radioactive. Questions regarding target sample availability, characterization, and, in the case of radioactive isotopes, manipulation and transportation, should be given sufficient attention and addressed at the European level. Coordination/networking of target production facilities should be strongly encouraged and standardized procedures for transportation and handling foreseen.

In view of radioactive isotope targets, concern is expressed about the situation of radiochemistry. Due to decreasing manpower and funding, the outstanding European expertise and knowledge in this field is in danger to be lost. Immediate action may consist in establishing a network of centres in which radiochemists are still active to serve needs of the nuclear physics community. Long term planning should include new Radiochemical Centres of Excellence providing education, training, and promotion of radiochemistry.

Many of the small scale facilities as well as installations at large scale facilities are unique within Europe due to the special equipment or application they provide. In order to stay at the forefront, the support for these application oriented activities should be enforced.

For public presentations or when arguing with funding agencies, Nuclear Physics facilities tend to present and emphasize the activities related to applications or to other domains. However, in many cases, groups working in these fields, in particular energy, health or material science have difficulties to obtain beam time. Therefore, beam time quota should be considered and/or dedicated Programme Advisory Committees should be installed.

For future developments and to keep the European cutting-edge position it is strongly recommended to closer interlink the existing complementary equipment and areas of specialization provided by the many facilities. Networking between fundamental physicists and end-users (reactor physicists, medical physicists, engineers...) should be reinforced. European networks of infrastructures (for instance of IBA, and AMS or high-energy irradiation facilities) would also be useful to facilitate the transfer of technology and training personnel. Communication with medical doctors, climate scientists, environmental scientists, archaeologists, curators, and other potential beneficiaries of the nuclear techniques should be improved, through non-technical publications, outreach activities, and joint meetings.

Most probably, one of the major contributions of Nuclear Physics to society is the human capital trained in basic Nuclear Physics techniques that is transferred to industry (in particular nuclear industry), medical centres, applied research organizations or governmental bodies linked to the different aspects of nuclear applications (as radioprotection and safety authorities), and that guarantees these organizations have the necessary expertise.

# 5. Annexes

---





## 5.1 Contributors

---

Hartmut Abele (Wien) • Navin Alahari (Caen) • Constantia Alexandrou (Nicosia) • Alberto Aloisio (Napoli) • Giacomo de Angelis (Padova) • Mauro Anselmino (Torino) • Thomas Aumann (Darmstadt) • Reinhard Beck (Bonn) • Michael Bender (Bordeaux) • José Benlliure (Santiago de Compostela) • Mike Birse (Manchester) • Bertram Blank (Bordeaux) • Yorick Blumenfeld (CERN) • Maria José Garcia Borge (Madrid) • Andrew Boston (Liverpool) • Angela Bracco (Milano) • Tullio Bressani (Torino) • Peter Butler (Liverpool) • Massimo Caccia (Milano) • Roberto Calabrese (Ferrara) • Giuseppe Cardella (Catania) • Nicolas Chamel (Bruxelles) • Philippe Chomaz (Saclay) • Raquel Crespo (Lisbon) • Michael Doser (CERN) • Guido Drexlin (Karlsruhe) • Marco Durante (Darmstadt) • Brian Fulton (York) • Hans Fynbo (Aarhus) • Zsolt Fülöp (Debrecen) • Sydney Galès (Paris) • Jens Jørgen Gaardhøje (Copenhagen) • Andres Gadea (Valencia) • Santo Gammino (Catania) • Paolo Giubellino (Torino) • Joaquim Gomez Camacho (Sevilla) • Carlo Guaraldo (Frascati) • Michel Guidal (Orsay) • Francesca Gulminelli (Caen) • Fairouz Hammache (Orsay) • Muhsin Harakeh (Groningen) • Sotirios Harissopulos (Athens) • Paul-Henri Heenen (Bruxelles) • Michael Heil (Darmstadt) • Thierry Hennino (Orsay) • Fritz Hessberger (Darmstadt) • Sigurd Hofmann (Darmstadt) • Dezső Horváth (Budapest) • Mark Huyse (Leuven) • Jordi José (Barcelona) • Rauno Julin (Jyväskylä) • Klaus Jungmann (Groningen) • Ralf Kaiser (Glasgow) • Klaus Kirch (Villigen) • Wolfram Korten (Saclay) • Jan Kucera (Řež) • Andrej Kugler (Řež) • Silvia Lenzi (Padova) • Sylvie Leray (Saclay) • Alain Letourneau (Saclay) • Frank Maas (Mainz) • Douglas MacGregor (Glasgow) • Adam Maj (Kraków) • Pier Andrea Mandò (Florence) • Gabriel Martínez Pinedo (Darmstadt) • Ulf Meißner (Jülich/Bonn) • Eugenio Nappi (Bari) • Gerda Neyens (Leuven) • Thomas Nilsson (Göteborg) • Joakim Nystrand (Bergen) • Francois de Oliveira (Caen) • Jean-Yves Ollitrault (Saclay) • Krzysztof Pachucki (Warsaw) • Giuseppe Pappalardo (Catania) • Thomas Peitzmann (Utrecht) • Primož Pelicon (Ljubljana) • Klaus Peters (Darmstadt) • Mihai Petrovici (Bucharest) • Fabrice Piquemal (Bordeaux) • Alfredo Poves (Madrid) • Paolo Prati (Genova) • Thomas Rauscher (Basel) • Krzysztof Redlich (Wrocław) • Miguel Angel Respalda (Sevilla) • Francesco Paolo Romano (Catania) • Stefano Romano (Catania) • Günther Rosner (Glasgow) • Patricia Roussel-Chomaz (Caen) • Robert Roth (Darmstadt) • Francisco Javier Santos Arévalo (Sevilla) • Andries van der Schaaf (Villigen) • Andreas Schäfer (Regensburg) • Christoph Scheidenberger (Darmstadt) • Karl-Heinz Schmidt (Darmstadt) • Stefan Schönert (Heidelberg) • Bent Schröder (Lund) • Björn Seitz (Glasgow) • Peter Senger (Darmstadt) • Nathal Severijns (Leuven) • Lembit Sihver (Göteborg) • Raimond Snellings (Amsterdam) • Kerstin Sonnabend (Darmstadt) • Madeleine Soyeur (Saclay) • Jean-Christophe Sublet (Culham) • Antoni Szczurek (Kraków) • Rob Timmermans (Groningen) • Marcel Toulemonde (Caen) • Christina Trautmann (Darmstadt) • Marc Vanderhaeghen (Mainz) • Andrea Vitturi (Padova) • Christof Vockenhuber (Zürich) • Cristina Volpe (Orsay) • Dario Vretenar (Zagreb) • Jochen Wambach (Darmstadt) • Christian Weinheimer (Münster) • Johannes Wessels (Münster) • Eberhard Widmann (Wien) • Urs Wiedemann (Geneva) • Ulrich Wiedner (Bochum) • Marc Winter (Strasbourg) • Phil Woods (Edinburgh) • Oliver Zimmer (Grenoble)

## 5.2 NuPECC Committee

---

### Members:

- **Façal Azaiez**, Orsay (France)
- **Maria José García Borge**, Madrid (Spain)
- **Angela Bracco**, Milano (Italy)
- **Gheorghe Cata-Danil**, Bucharest (Romania)
- **Chomaz Philippe**, Saclay (France)
- **Roman Čaplar**, Zagreb (Croatia)
- **Jan Dobeš**, Řež (Czech Republic)
- **Ana Maria Eiró**, Lisbon (Portugal)
- **Jens Jørgen Gaardhøje**, Copenhagen (Denmark)
- **Sotirios Harissopulos**, Athens (Greece)
- **Paul-Henri Heenen**, Bruxelles (Belgium)
- **Tord Johansson**, Uppsala (Sweden)
- **Ari Jokinen**, Jyväskylä /Finland)
- **Klaus Jungmann**, Groningen (The Netherlands)
- **Bernd Krusche**, Basel (Switzerland)
- **Eugenio Nappi**, Bari (Italy)
- **Paul Nolan**, Liverpool (United Kingdom)
- **Thomas Peitzmann**, Utrecht (The Netherlands)
- **Achim Richter**, ECT\* Trento (Italy)
- **Dieter Röhrich**, Bergen (Norway)
- **Günther Rosner**, Glasgow (United Kingdom)
- **Christelle Roy**, Strasbourg (France)
- **Horst Stöcker**, Darmstadt (Germany)
- **Hans Ströher**, Jülich (Germany)
- **Jan Styczeń**, Kraków (Poland)
- **Jochen Wambach**, Darmstadt (Germany)
- **Eberhard Widmann**, Wien (Austria)
- **György Wolf**, Budapest (Hungary)

### Observers:

EPS/NPB:

- **Jan Kvasil**, Řež (Czech Republic)

NSAC:

- **Susan Seestrom**, Los Alamos (USA)

ANPhA:

- **Hideyuki Sakai**, Tokyo (Japan)

### Chairman:

- **Günther Rosner**

Department of Physics and Astronomy,  
University of Glasgow,  
Glasgow G12 8QQ, UK  
Tel: +44 141 330 2774  
Fax: +44 141 330 2630  
Email: g.rosner@physics.gla.ac.uk

### Scientific secretariat:

- **Gabriele-Elisabeth Körner**

c/o Physikdepartment E12 der Technischen  
Universität München,  
85748 Garching, Germany  
Tel: +49 89 28 91 22 93 / +49 172 89 15 011  
Fax: +49 89 28 91 22 98  
Email: sissy.koerner@ph.tum.de

### European Science Foundation:

- **Neil Williams**

Head of Unit, Physical and Engineering Sciences  
European Science Foundation  
1 quai Lezay-Marnésia, BP 90015  
67080 Strasbourg cedex, France  
Tel: +33 3 88 76 71 43  
Fax: +33 3 88 37 05 32  
Email: nwilliams@esf.org

## 5.3 Acronyms and Abbreviations

|                |  |                   |   |
|----------------|--|-------------------|---|
| <b>ADS</b>     | accelerator driven system  | <b>EoS</b>        | equation of state   |
| <b>AGATA</b>   | Advanced GAMMA Tracking Array  | <b>ESFRI</b>      | European Strategic Forum for Research Infrastructures                 |
| <b>AGB</b>     | asymptotic giant branch  | <b>EURISOL</b>    | European ISOL facility  |
| <b>ALICE</b>   | A Large Ion Collider Experiment  | <b>EWIRA</b>      | East West Integrated Research Activities                              |
| <b>AMS</b>     | accelerator mass spectroscopy  | <b>EXL</b>        | Exotic nuclei studied with Electromagnetic and Light hadronic probes  |
| <b>ANC</b>     | asymptotic normalization coefficient   | <b>FAIR</b>       | Facility for Antiproton and Ion Research                              |
| <b>APNC</b>    | atomic parity non-conservation   | <b>FAZIA</b>      | 4 $\pi$ A and Z Identification Array                                  |
| <b>ASIC</b>    | application specific integrated circuit                                      | <b>FF</b>         | form factor   |
| <b>ATLAS</b>   | A Toroidal LHC Apparatus   | <b>FLAIR</b>      | Facility for Low-energy Antiproton and Ion Research                   |
| <b>BABAR</b>   | B and B-bar experiment   | <b>FMD</b>        | fermionic molecular dynamics  |
| <b>BBN</b>     | big-bang nucleosynthesis   | <b>FMT</b>        | fluorescence-mediated tomography                                      |
| <b>BNCT</b>    | boron neutron capture therapy  | <b>FP6</b>        | EU Framework Programme 6  |
| <b>BNL</b>     | Brookhaven National Laboratory   | <b>FP7</b>        | EU Framework Programme 7  |
| <b>CBM</b>     | Compressed Baryonic Matter   | <b>FPGA</b>       | field programmable gate arrays  |
| <b>CD</b>      | Coulomb dissociation   | <b>FRM-II</b>     | Forschungsreaktor München II  |
| <b>CEA</b>     | Commissariat d'Énergie Atomique  | <b>FRS</b>        | fragment separator  |
| <b>CEBAF</b>   | Continuous Electron Beam Accelerator Facility                                | <b>GANIL</b>      | Grand Accélérateur National d'Ions Lourds                             |
| <b>CERN</b>    | Conseil Européen pour la Recherche Nucléaire                                 | <b>GCR</b>        | galactic cosmic rays  |
| <b>ChPT</b>    | chiral perturbation theory   | <b>GPD</b>        | generalised parton distributions                                      |
| <b>CKM</b>     | Cabbibo-Kobayashi-Maskawa  | <b>GSI</b>        | Gesellschaft für Schwerionenforschung                                 |
| <b>CLAS</b>    | CEBAF large acceptance spectrometer  | <b>GT</b>         | Gamow-Teller  |
| <b>CMB</b>     | cosmic microwave background  | <b>GUT</b>        | grand unification theory  |
| <b>CMS</b>     | Compact Muon Solenoid  | <b>HADES</b>      | High Acceptance Di-Electron Spectrometer                              |
| <b>CNRS</b>    | Conseil National de la Recherche Scientifique                                | <b>HERA</b>       | Hadron-Elektron-Ring-Anlage   |
| <b>COMPASS</b> | Common Muon Proton Apparatus for Structure and Spectroscopy                  | <b>HERMES</b>     | HERA experiment for spin physics                                      |
| <b>COSY</b>    | COoler SYnchrotron   | <b>HESR</b>       | high energy storage ring  |
| <b>CT</b>      | computed tomography  | <b>HIE-ISOLDE</b> | high intensity and energy upgrade of ISOLDE                           |
| <b>CVC</b>     | conserved vector current   | <b>HIT</b>        | Heidelberger Ionenstrahl Therapie                                     |
| <b>CZT</b>     | cadmium zinc telluride   | <b>HQEFT</b>      | heavy quark effective field theory                                    |
| <b>DESY</b>    | Deutsches Elektronensynchrotron  | <b>IBA</b>        | ion beam analysis   |
| <b>DIS</b>     | deep-inelastic scattering  | <b>ILL</b>        | Institut von Laue – Langevin  |
| <b>DVCS</b>    | deeply virtual Compton scattering  | <b>IN2P3</b>      | Institut National de Physique Nucléaire et de Physique des Particules |
| <b>DWBA</b>    | distorted wave Born approximation  | <b>INFN</b>       | Istituto Nazionale di Fisica Nucleare                                 |
| <b>ECOS</b>    | European Consortium on Stable beams  | <b>IPN</b>        | Institut de Physique Nucléaire  |
| <b>ECT*</b>    | European Centre for Theoretical studies in nuclear physics and related areas | <b>ISOL</b>       | isotope separation on-line  |
| <b>EDF</b>     | energy density functional  | <b>ISOLDE</b>     | ion separator on-line at CERN   |
| <b>EDM</b>     | electric dipole moment   | <b>ISS</b>        | International Space Station   |
| <b>EFT</b>     | effective field theory   | <b>IUPAP</b>      | International Union of Pure and Applied Physics                       |
| <b>EIC</b>     | Electron Ion Collider  | <b>JINR</b>       | Joint Institute for Nuclear Research                                  |
| <b>ELENA</b>   | Extra Low Energy Antiproton Ring   | <b>JLab</b>       | Thomas Jefferson National Accelerator Facility                        |
| <b>ELI</b>     | Extreme Light Infrastructure   |                   |   |
| <b>ENC</b>     | Electron Nucleon Collider  |                   |   |
| <b>ENSAR</b>   | European Nuclear Science and Applications Research                           |                   |   |

## 5.3 Acronyms and Abbreviations

---

|               |  |               |   |
|---------------|--|---------------|---|
| <b>JRA</b>    | joint research activity  | <b>SMMC</b>   | shell-model Monte Carlo                                     |
| <b>JYFL</b>   | University of Jyväskylä  | <b>SN</b>     | supernova   |
| <b>KVI</b>    | Kernfysisch Versneller Instituut                               | <b>SNM</b>    | special nuclear material                                    |
| <b>LCB</b>    | laser Compton backscattering                                   | <b>SPE</b>    | solar particle events                                       |
| <b>LEAR</b>   | Low Energy Antiproton Ring                                     | <b>SPECT</b>  | single-photon emission computerized tomography              |
| <b>LEO</b>    | low earth orbit  | <b>SPES</b>   | Selective Production of Exotic Species                      |
| <b>LET</b>    | linear energy transfer   | <b>SPIRAL</b> | Système de Production d'Ions Radioactifs Accélérés en Ligne |
| <b>LHC</b>    | Large Hadron Collider  | <b>SUSY</b>   | supersymmetry   |
| <b>LHeC</b>   | Large Hadron electron Collider                                 | <b>TASCA</b>  | TransActinide Separator and Chemistry Apparatus             |
| <b>LNGS</b>   | Laboratory Nazionali di Gran Sasso                             | <b>THM</b>    | Trojan horse method   |
| <b>LNL</b>    | Laboratori Nazionali di Legnaro                                | <b>TMD</b>    | transverse momentum dependent distribution function         |
| <b>LNS</b>    | Laboratori Nazionali del Sud                                   | <b>TNA</b>    | transnational access  |
| <b>LNT</b>    | linear-no-threshold  | <b>TOF</b>    | time of flight  |
| <b>LQCD</b>   | lattice QCD  | <b>WD</b>     | white dwarf   |
| <b>LUNA</b>   | Laboratory Underground for Nuclear Astrophysics                | <b>WEP</b>    | weak-equivalence principle                                  |
| <b>MAMI</b>   | Mainz Mikrotron  |               |   |
| <b>MAPS</b>   | monolithic active pixel sensors                                |               |   |
| <b>MC</b>     | Monte Carlo  |               |   |
| <b>MPGD</b>   | micro-pattern gas detectors                                    |               |   |
| <b>MRI</b>    | magnetic resonance imaging                                     |               |   |
| <b>NA49</b>   | North Area, CERN, Experiment 49                                |               |   |
| <b>NCSM</b>   | no-core shell model  |               |   |
| <b>NIF</b>    | National Ignition Facility                                     |               |   |
| <b>NIST</b>   | National Institute of Standards and Technology                 |               |   |
| <b>NuSTAR</b> | Nuclear Structure, Astrophysics and Reactions                  |               |   |
| <b>PANDA</b>  | antiProton ANnihilation at DArmstadt                           |               |   |
| <b>PARIS</b>  | Photon Array for studies with Radioactive Ion and Stable beams |               |   |
| <b>PAX</b>    | Polarized Antiproton eXperiments                               |               |   |
| <b>PET</b>    | positron emission tomography                                   |               |   |
| <b>PHELIX</b> | Petawatt High Energy Laser for heavy Ion eXperiments           |               |   |
| <b>PSI</b>    | Paul-Scherrer-Institut   |               |   |
| <b>PVeS</b>   | parity-violating electron scattering                           |               |   |
| <b>QCD</b>    | quantum chromodynamics   |               |   |
| <b>QED</b>    | quantum electrodynamics  |               |   |
| <b>R3B</b>    | Reactions with Relativistic Radioactive Beams                  |               |   |
| <b>RBE</b>    | relative biological effectiveness                              |               |   |
| <b>RHIC</b>   | Relativistic Heavy Ion Collider                                |               |   |
| <b>RPA</b>    | random phase approximation                                     |               |   |
| <b>SEE</b>    | single event effect  |               |   |
| <b>SEU</b>    | single event upset   |               |   |
| <b>SHE</b>    | superheavy elements  |               |   |
| <b>SLAC</b>   | Stanford Linear Accelerator                                    |               |   |
| <b>SM</b>     | standard model or shell model                                  |               |   |



Published by the European Science Foundation  
November 2010  
Printing: IREG, Strasbourg  
ISBN: 978-2-918428-29-9

**For more information contact:**

**Professor Günther Rosner**

*NuPECC Chair*  
School of Physics and Astronomy  
University of Glasgow  
University Avenue  
Glasgow G12 8QQ  
United Kingdom  
Tel: +44 141 330 2774  
Fax: +44 141 330 2630  
Email: g.rosner@physics.gla.ac.uk

---

**Dr Gabriele-Elisabeth Körner**

*NuPECC Scientific Secretary*  
c/o Physik-Department E 12  
Technische Universität München  
85748 Garching  
Germany  
Tel: +49 89 2891 2293  
Fax: +49 89 2891 2298  
Email: sissy.koerner@ph.tum.de

**[www.nupecc.org](http://www.nupecc.org)**

---

**Physical and Engineering  
Sciences Unit**

*European Science Foundation*  
1 quai Lezay-Marnésia  
BP 90015  
67080 Strasbourg cedex  
France  
Tel: +33 3 88 76 71 00  
Fax: +33 3 88 37 05 32  
Email: pesc@esf.org or  
lrp2010@esf.org

**[www.esf.org](http://www.esf.org)**

**E**UROPEAN  
**S**CIENCE  
**F**OUNDATION  
SETTING SCIENCE AGENDAS FOR EUROPE

**NuPECC**