

Current and Future Research Directions in Nuclear Physics in Canada

Prepared by the Nuclear Physics Brief-writing committee of the Canadian Institute of
Nuclear Physics (CINP)

Authors:

Krzysztof Starosta, Simon Fraser University
Charles Gale, McGill University
Gerald Gwinner, University of Manitoba
Barry Davids, TRIUMF
Corina Andreoiu, Simon Fraser University
Peter Blunden, University of Manitoba

Edited by: Kumar Sharma, University of Manitoba



Prepared for the Long Range Planning Committee of the Subatomic Physics Evaluation
Section (SAPES) of the Natural Sciences and Engineering Research Council of Canada
(NSERC)

Table of Contents

1. Introduction	3
1.1. Consultation Process	4
2. Executive summary	5
3. Nuclear Physics Research in Canada	7
3.1. The structure of nuclear matter	7
3.2. Nuclear astrophysics	40
3.3. Fundamental symmetries and physics beyond the standard model	50
3.4. Hadrons and QCD	68
4. Demographics, Facilities and Dynamics	87
4.1. Nuclear physics theory overview	87
4.2. Facilities	91
4.3. Education and demographics	95
4.4. Funding dynamics	97
4.5. Discipline dynamics and the CINP	99

1 Introduction

Nuclear physics by necessity includes a wide range of topics from the properties and interactions of hadrons to the properties of infinite nuclear matter and neutron stars. A complete theoretical description of the strongly interacting many body systems that make up hadrons and nuclei is very challenging and not available at the current time. However, significant theoretical progress has been made to the point where an ab-initio theory that is capable of describing the properties of the lighter nuclei is starting to emerge. A more complete understanding can only be attained through a clear elucidation of nuclear properties and structure through experimental efforts. With a detailed understanding of the nuclear physics that determines the behaviour of specific nuclei, one can exploit particular opportunities to test the fundamental symmetries of nature in regimes that are far from what is currently possible to directly probe with high energy physics experiments. The properties of nuclei far from stability are essential in understanding the synthesis of the elements from the primordial plasma of the Big Bang through the life cycle of stars to the ejecta of supernovae.

We are at the threshold of a period that will see several advanced radioactive beam facilities, across the world, begin operation and provide unprecedented access to such nuclei for the first time. Canada is fortunate to have the first of these full fledged facilities, ISAC-I and II at TRIUMF, operational and available for use by our community. Indeed, a very large fraction of the Canadian nuclear physics effort is based at TRIUMF and a number of very talented teams have assembled to make use of this facility. A wise and careful stewardship of this valuable Canadian resource is essential in ensuring the success of the experimental programs based at TRIUMF and to allow Canadian nuclear physicists to capitalize on the excellent suite of instrumentation in place at ISAC in a timely manner. The continued development of the ISAC facility is essential if we are to maintain the cutting-edge position that TRIUMF currently enjoys in this field.

It is efficient and justifiable for Canadian nuclear physicists to use their resources and expertise to exploit unique opportunities in their field at other available facilities when their efforts show a promise of significant impact. For example, with over 6000 nuclei predicted to exist, radioactive beam facilities have their areas of strengths and weaknesses in providing beams of specific nuclei for study. Another example is the study of QCD in the strongly interacting regime, examining the basic properties of hadrons, which plays an important role in nuclear physics and provides an interface between nuclear and particle physics. Experimental programs in this subject are only possible at laboratories outside Canada. Past work over many years at the Saskatchewan Accelerator Laboratory (SAL), TRIUMF and other laboratories has allowed the formation of a few groups in Canada who have taken a leadership role and made significant experimental and theoretical contributions in focused areas. With the upgrades planned at the Jefferson Laboratory (JLab) and other locations it appears that Canadians will have opportunities to continue this strong performance record over the next 10 years. A focused off-shore program enhances the profile of Canadian science internationally and builds international collaborations that will benefit Canadian science in the long run.

Canadian efforts in nuclear physics research address topics from each of the 4 universal facets of nuclear science. Detailed descriptions of nuclear physics efforts in each of the broad sub-fields of the discipline are presented in section 3 titled “Nuclear Physics Research in Canada”. A majority of this work is based at ISAC and involves the largest fraction of the nuclear physics community in Canada. The excellence of this facility, the suite of equipment available and the research personnel has been and is currently successful at attracting a growing international community to participate in these efforts. A smaller fraction of the Canadian community is active in focused efforts of high impact at other facilities. They are mostly organized into groups that make efficient use of the funding provided to them and their efforts are recognized as excellent internationally. Overall, the research program addresses the wide scope of the discipline in a focused manner that exploits Canadian skills, talents and resources very effectively.

1.1 Consultation Process:

The Canadian Institute of Nuclear Physics (CINP) was tasked by the NSERC SAPES (Subatomic Physics Evaluation Section) Long Range Plan (LRP) committee to prepare a brief that would provide them with a description of the goals and aspirations of the Canadian nuclear physics research community over the period of the next 5 to 10 years. The report was to provide a description of what physics goals could be achieved at the current levels of funding (possibly augmented in a modest manner) allocated to the SAPES envelope.

The process followed by the CINP began at the CAP 2010 Congress in Toronto where the community endorsed a format for the brief that would be similar to the previous brief formulated by the Division of Nuclear Physics (DNP) of the Canadian Association of Physicists (CAP) during the last 5-year plan exercise. A committee consisting of the chairs of the 5 scientific working groups focused on the key areas of Nuclear Physics: Nuclear Structure (Krzysztof Starosta), Nuclear Astrophysics (Barry Davids), QCD and Hadron Physics (Charles Gale), Fundamental Symmetries (Gerald Gwinner) and Education and Training (Corina Andreoiu) of the CINP, a representative of Nuclear Physics theory (Peter Blunden) and chaired by the director of the CINP (Kumar S. Sharma) was assembled.

The members of the community were contacted by email and information was gathered from individuals about the current status and future plans of their research programs. Input was obtained from a nearly complete set of individuals active in nuclear physics research. This information was used by the chairs of the working groups to formulate section 3 of this report titled “Nuclear Physics Research in Canada” where each of the 4 sections describes the work being carried out or planned in 4 broad scientific areas of investigation: nuclear structure, nuclear astrophysics, fundamental symmetries, and hadrons and QCD. The chair of the working group on Education and Training formulated the section on demographics and Peter Blunden produced the section providing an overview of theory efforts. It should be noted that these 4 broad areas of activity are universally used to describe work in nuclear physics by long range plans produced by

NUPECC in Europe, NSAC in the USA and other similar plans in Japan, China and other countries.

The drafts of these parts of the brief were circulated to the community and a town-hall meeting was held in Winnipeg (September 11th and 12th, 2010) to discuss their content and to gather further suggestions on the construction of the brief. The brief was modified based on the comments received and a relatively complete draft of the brief was circulated to the community on October 8th, 2010. Following this, most of the brief-writing committee met at Simon Fraser University on October 12th and 13th to construct a final draft version of the brief. The brief was again circulated for comment and after incorporating any necessary changes was submitted to NSERC.

This is the first time that the newly formed CINP was involved in the production of a LRP. The information gathered by this committee during this process represents the start of an ongoing tracking of progress in the nuclear physics community by the CINP. This will facilitate future long range planning for the discipline.

2 Executive Summary

The body of this document describes the Nuclear Physics research efforts in Canada. The main recommendations and suggestions outlined in these sections can be summarized in the following points: Some specific suggestions and observations appear in section 4 of this document and are underlined.

2.1 Maintain a broad based program of research

Nuclear physics research spans a wide range of fundamental scientific questions about the properties of hadrons and nuclei. The focused experimental and theoretical initiatives at home and abroad of teams of Canadian researchers have made internationally recognized contributions to important questions that span the range of the field. This work capitalizes on the skills and strengths that have been developed over many years. A broad based nuclear physics research program that addresses important scientific questions must continue to be supported.

2.2 Exploit the ISAC facility at TRIUMF to its full scientific potential

The highest priority for nuclear physics in Canada in the next ten years is the full exploitation of the high-intensity radioactive beams for structure and reaction studies at ISAC-I and ISAC-II. TRIUMF's ISAC leads the world with the highest primary driver beam power among ISOL-based radioactive beam facilities. For ISAC to realize its full potential and exploit the advantage it currently enjoys over its competitors, increased efforts in target and ion-source development are urgently required. In order to leverage

the considerable investments Canada has made through NSERC and CFI, new radioactive beams including accelerated beams with $A > 30$ must be developed and all beams must be reliably delivered to the existing and planned experimental facilities coming on-line.

2.3 Develop new experimental capabilities at TRIUMF

Over the next 10 years, a number of next-generation radioactive beam facilities are expected to begin operating worldwide. In order for the Canadian nuclear science community to sustain its leadership in the field it is critical that TRIUMF upgrade the capabilities of ISAC. Some of the planned high priority research requires the development of a second ISAC proton beam line in addition to the new actinide target stations that will be required for ARIEL. This would put ISAC on a trajectory to become the first multi-user radioactive beam facility worldwide with unprecedented potential for scientific discovery and advancement in the field.

2.4 Support significant Canadian contributions in offshore nuclear physics research

Some of the important questions addressed by present nuclear physics research are only accessible by experiments done by international collaborations at offshore facilities. Canadians continue to make recognized high impact contributions and assume leadership roles in many such efforts. While limited funding has made it possible to pursue only selected opportunities, history has proven that such activities have greatly enhanced the visibility, breadth, and richness of the Canadian nuclear physics research program for a relatively limited investment. Participation by Canadians in experiments at offshore facilities should be supported in order to maintain a balanced and diversified nuclear physics research program.

2.5 Review funding structure

The funding of Canadian scientific efforts involves NSERC, CFI, other federal, provincial, and university based funds. As demands for operating funds placed increasing strains on the NSERC SAP envelope, funds from other sources such as the CFI programs have played an increasing role in funding the capital costs associated with new facilities and research tools. A dialog between the various granting agencies aimed at clarifying and coordinating the application and decision process would be highly desirable.

3 Nuclear physics research in Canada

3.1 Structure of Nuclear Matter

3.1.1 Overview of the major scientific questions and current efforts addressing them

The modern era of nuclear physics was launched with the introduction of two Nobel prize-winning models: the shell model (1963 E.P. Wigner, M. Goeppert-Mayer and J.H.D. Jensen) and the collective model (1975 A.N. Bohr, B.R. Mottelson, and L.J. Rainwater). These models were proposed in response to compelling experimental evidence obtained from studies of nuclei far from the valley of stability. They have since been developed to a high level of sophistication and, together with the theory of nuclear superconductivity, have provided for the foundational framework for interpreting the abundance of nuclear structure data that is available near the valley of stability and for the nuclei near the proton drip-line.

Major breakthroughs accomplished in nuclear structure theory in coincidence with significant progress in experimental techniques are the forces which drive the current revival of the field. On the theory side it is currently possible to derive properties of light nuclei completely from first principles. For medium masses sophisticated methods have been established through well understood and controlled approximations. With this progress the theory of nuclear structure is swiftly moving from being descriptive to being predictive. On the experimental side availability of radioactive beams realized in the past two decades leads towards enormous expansion of nuclear species which can be produced and isolated for study. This progress goes hand in hand with perfection of experimental tools which have reached an unprecedented level of sensitivity.

Major scientific questions under investigation by the nuclear structure community are formulated in an excellent way in the latest TRIUMF 5 year plan:

- *What are the limits of nuclear existence?*
- *How do the properties of nuclei evolve as a function of the neutron-proton asymmetry?*
- *How do the properties of nuclei evolve as a function of proton and neutron number?*
- *What are the mechanisms responsible for the organization of individual nucleons into the collective motions that are observed?*

The main excitement of the field is driven by the fact that the nuclear structure community in Canada can, during the tenure of the 2011-2016 Long Range Plan, be in a position to address these questions in a quantitative way, in many cases for complete chains of isotopes or isotones between the proton and neutron drip-lines.

The above questions are well aligned with scientific objectives of the international nuclear science community, in particular with the efforts driving the construction of NSCL/ FRIB in the US, SPIRAL-II in France and FAIR in Germany, as well as the operation of RIBF in Japan and ISOLDE in Switzerland. It should be stressed that the Canadian nuclear structure community plays a leadership role in this world-wide effort taking full advantage of the fact that ISAC at TRIUMF is the highest power isotope separation on-line (ISOL) facility in the world. While the alignment of scientific goals of Canadian and international science community fosters collaborations it also gives Canadian scientist the advantage of being on the front line, effectively driving the development of critical projects defining the future of the field. Indeed, re-acceleration of radioactive beams, charge state boosting, gamma-ray tracking and advance beta-decay spectrometry which are either at an advance stage of development or routinely operated at ISAC are projects planned or pursued in a number of laboratories worldwide. Canadian leadership in experimental nuclear physics is also a factor that attracts large numbers of foreign scientists to participate in the ISAC program at TRIUMF.

Experimentally, the major scientific questions of nuclear structure are addressed by measurements of masses and beta-decay lifetimes of ground and isomeric metastable states, identification of excited states, measurements of electromagnetic transition matrix elements and moments, as well as studies of nuclear reaction dynamics with various probes. Only seldom is the phenomenon under investigation fully elucidated by a single measurement. More frequently, results of a number of experiments need to be combined to provide complementary information that adds to form the full picture of the physics. In this respect it is critical to emphasize the synergy between various spectrometry tools that are available, under construction, or planned at the ISAC facility at TRIUMF. While a number of them, such as the 8π and TIGRESS gamma-ray arrays, with their auxiliary detectors, the ion-trap TITAN, the recoil spectrometer EMMA, or the solid-hydrogen-target facility IRIS, are discussed below in detail, it is important to stress that in numerous cases, as illustrated by the research highlights below, the progress in understanding critically depends on the broad information available through coordinated efforts of experimental programs at ISAC and other facilities worldwide.

In a broad sense, measurements in nuclear structure yield information about the single particle states in the nuclear potential, nuclear collective excitations, and effective interactions among nucleons in nuclei. Current interest, as indicated by the major questions outlined above, is focused on the impact of the proton-neutron imbalance, or the isospin dependence, on the structure of nuclear matter. Experimentally, three major directions are pursued by the Canadian community: first, investigations of neutron-deficient nuclei along the proton dripline, next, studies of nuclei along the $N=Z$ line where protons and neutrons occupy the same shell model orbitals, and finally, studies focused on nuclei with large excess of neutrons moving towards the neutron dripline. All three areas are of direct interest to nuclear astrophysics, since the first two provide information on nuclei involved in the rapid-proton-capture process, and the last for the rapid-neutron-capture process. The program of studies along the $N=Z$ line has significant overlap with the interests of the fundamental symmetries community in the superallowed beta-decay emitters are located in that region. Another important example of synergy

between nuclear structure and fundamental symmetries efforts is provided by investigation of single-particle and collective excitations in actinide nuclei with the ultimate goal of aiding the measurement of the electric dipole moment in ^{223}Rn , as well as nuclear structure contributions to measurements of matrix elements in nuclei involved in neutrino-less double beta-decay.

Several research highlights from the Canadian nuclear structure community, undertaken during the tenure of the current Long Range Plan, are presented below. These document progress in understanding the properties of exotic nuclei which results from the combined effort of nuclear theory and the experimental programs at ISAC and elsewhere.

Topic 1: Structure of nuclear halo in light, neutron-rich systems

One of the most attractive objects of study for nuclear structure are halo nuclei, nuclei with very unusual, extreme properties. Halo nuclei exist both as neutron and proton halos and typically consist of a core nucleus, like ^4He , with added extra protons or neutrons. The extra nucleons, like the neutrons in for example ^{11}Li or ^{11}Be are bound very loosely to the core and reside in very large orbits, exhibiting satellite-like features, hence the name halo. Neutron halo nuclei in particular have been found in regions of very neutron rich nuclei, typically in the mass landscape below or around $A=20$ to 30 . This represents an excellent opportunity for nuclear theory since here many ‘few-body’ tools apply and can be tested to a very high level by the amplified behavior of halo nuclei. A goal of nuclear theory is to reproduce and, ideally, predict basic properties of nuclei, such as their mass (or binding energy), shape, half-life, etc. This requires direct comparisons of experimental to theoretical results, something that has been impossible for the very short-lived halo nuclei, found at the neutron drip lines. Various key studies of the nuclear halo systems performed at ISAC are highlighted below.

Highlight 1. Halo nuclei mass measurements from TITAN

With ISAC access to intense beams of halo nuclei is now possible and numerous experiments have been carried out. A highlight amongst them is the precision mass determination of halo nuclei with the ion trap system called TITAN. The mass, as one of the most fundamental properties of a nucleus, provides access to the strong interaction relevant for the nuclear binding, and is a sensitive tool in the determination of the size and shape of nuclei, including the extent of the halo radius itself. The experimental findings are then subject to comparisons to the most advanced theoretical predictions, including *ab-initio* calculations based on two and three-body nuclear interactions.

Penning ion traps, such as the one used at TITAN, have long been identified as the most precise tool for mass determinations of stable species where unlimited observation times lead to unprecedented precision. For unstable species, Penning traps were limited for a long time to isotopes with half-lives of approximately a second, more recently pushing towards hundreds of milliseconds. However, halo nuclei due to their very loosely bound character have half-lives in the millisecond range, for example for ^{11}Li ($t_{1/2}=8.6$ ms), while for ^{14}Be ($t_{1/2}=4.5$ ms). This tension between precision and half-life was overcome with TITAN where mass measurements of series of He, Li, and Be isotopes have been performed. This represents an advancement of the experimental technique by almost

factor of ten in half-life and sets a new record for Penning trap mass measurements. The results provided crucial input into the deeper understanding of nuclear structure and the underlying strong interaction in nuclei.

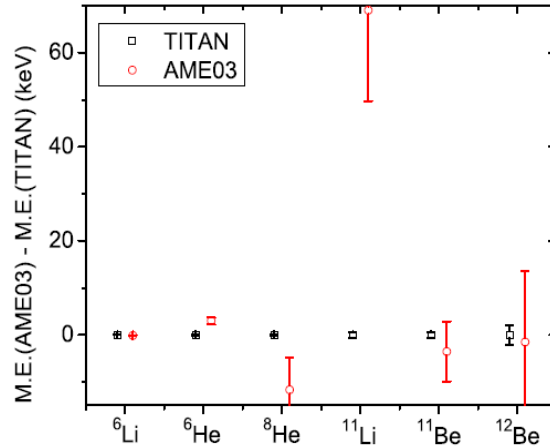

Fig. 3.1.1. The mass excess (M.E.) as derived from the TITAN mass measurements compared to previous measurements as evaluated by the AME

Fig. 3.1.1 illustrates the significant improvement in precision for the masses of the halo nuclei, but also shows the excellent agreement with the stable isotope ${}^6\text{Li}$, as confirmation of the accuracy of TITAN. Drastic deviations with previous measurements could be explained, and reliable mass and binding data now exist.

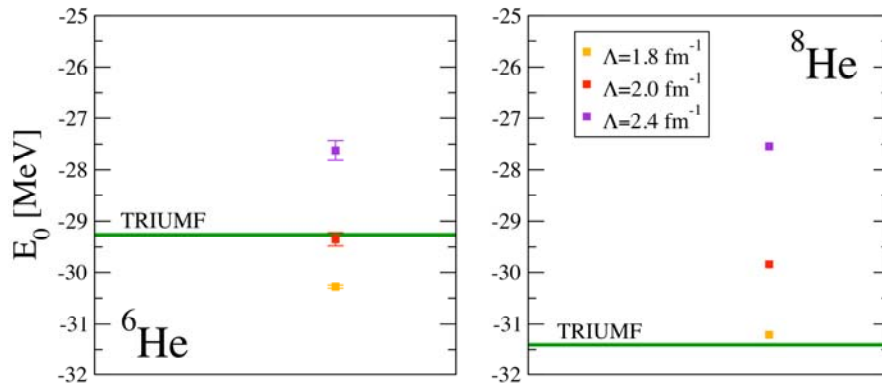

Fig. 3.1.2. Ground state energies of the halo nuclei ${}^6\text{He}$ and ${}^8\text{He}$ calculated with different two-body low momentum interactions from effective field theory potentials. Different colors correspond to different resolution scale parameters Λ in the two-body forces. ${}^6\text{He}$ is calculated with hyper-spherical harmonics and ${}^8\text{He}$ from coupled cluster theory. The running of the binding energy as a function of Λ points towards the need of including three-body forces. The line corresponds to the experimental values measured with TITAN at TRIUMF.

Theoretical predictions of binding energies and charge radii of these halo nuclei are now possible with exceedingly high precision and allow one to pin-point the relevant nuclear interactions. Fig. 3.1.2 shows results from *ab-initio* calculations that are directly compared to other theoretical approaches and the direct mass measurements from TITAN. Another parameter for comparison is the charge radius along the isotopic chains, where the halo feature will be recognizable. The charge radii can be derived from laser spectroscopy data, in combination with state-of-the-art atomic theory. A key ingredient here is also the high precision mass measurement from TITAN.

Highlight 2. β -NQR spectroscopy of neutron-rich lithium isotopes

One of the basic questions asked about the ^{11}Li nucleus is to what extent do the two halo neutrons affect the ^9Li core? Several years ago at TRIUMF it was shown that the root-mean square (RMS) charge radius of ^{11}Li was significantly larger than that of ^9Li showing that the outer neutrons were more than mere spectators. This renewed both theoretical and experimental interest in this question. The recent development of β -detected Nuclear Quadrupole Resonance (NQR) spectroscopy in a zero magnetic field at ISAC-I has significantly reduced the experimental uncertainty on the ratio of the static quadrupole deformation of ^9Li and ^{11}Li . Fig. 3.1.3 shows the experimental spectra for ^8Li , ^9Li , and ^{11}Li . The quadrupole moments are obtained from the resonant frequencies and a spin coupling factor. From these data the $^{11}\text{Li}/^9\text{Li}$ has been measured to be 1.077(1) an improvement of over an order of magnitude in precision over the current literature value.

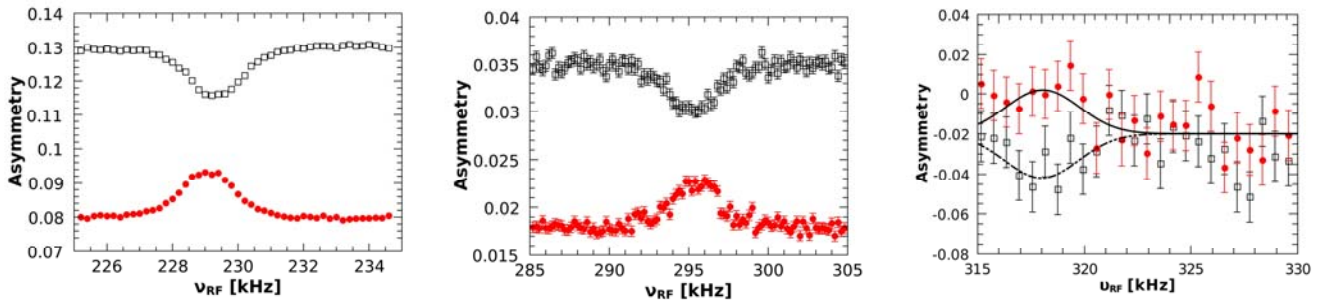

Fig. 3.1.3. β -NQR asymmetry spectra for (left) ^8Li , (center) ^9Li and (right) ^{11}Li ; the quadrupole moment of the ground state is extracted from the frequency of the resonance observed in the spectra.

Highlight 3. Halo in an isomeric state of ^{12}Be : $^{11}\text{Be}(d,p)^{12}\text{Be}$ reaction at ISAC-II

The neutron halo is a very unusual phenomenon whose complete understanding requires a careful study of evolution from normal nuclei to these exotic forms. So far, only a few neutron halo nuclei have been identified, in particular for nuclei with an even number of neutrons (N) an interesting question is whether and how pairing interaction between the valence neutrons can affect halo formation. The most prominent halo found in ^{11}Li (N=8) occurs in a Borromean nucleus whose two-body sub-system ^{10}Li is unbound. The isotonic neighbour to ^{11}Li is ^{12}Be , which is not a Borromean nucleus. Its subsystem ^{11}Be is a one-neutron halo. Therefore it serves as an interesting ground to investigate halo formation in

^{12}Be by adding one neutron to ^{11}Be . This was done using the newly developed high-intensity ^{11}Be beam ($\sim 10^5/\text{sec}$) accelerated to 5A MeV using the ISACII superconducting LINAC. The $d(^{11}\text{Be},p)^{12}\text{Be}$ one neutron transfer from a deuteron (deuterated polyethylene) target onto the incoming ^{11}Be beam was used to populate ^{12}Be . The reaction created ^{12}Be both in its ground state as well as in its excited states. The halo component (*neutron in the s-orbital*) in the ground state of ^{12}Be was found to be smaller than ^{11}Be and ^{11}Li . Interesting however, signature of halo component was seen for the first time in the long-lived (isomeric) 0^+ state of ^{12}Be , suggesting a halo character in its isomeric state. Such a feature can only be investigated using transfer reactions for which the ISACII facility at TRIUMF is ideally suited.

Highlight 4. Halo neutron correlation in ^{11}Li through the (p,t) reaction at ISAC-II

The nuclear halo in ^{11}Li exhibits a correlation of the two halo neutrons that is expected to differ from stable nuclei due to several reasons. Firstly, two halo neutrons are somewhat decoupled from the core and therefore have very small overlap with the wave function of protons inside the core. Secondly, the halo neutrons are very weakly bound and close to the neutron emission threshold implying that continuum states might have an important effect on the neutron-neutron correlation. Thirdly, the low density of the halo neutrons suggests possible changes in the pairing correlation. The spatial correlation of the two neutrons can be visualized as two extreme modes known as the cigar configuration and the di-neutron configuration. Over the last decade, various attempts have been made to study the two-neutron correlations in ^{11}Li . Two-neutron transfer reactions are sensitive tools to study neutron-neutron pairing correlations in nuclei. The ^{11}Li beam properties at TRIUMF's ISAC-II facility, coupled together with the powerful active target MAYA from GANIL made the pioneering experiment on $p(^{11}\text{Li},t)^9\text{Li}$ possible with the first accelerated beam from ISAC-II at 3A MeV.

In this experiment the ^9Li residue was observed in its first excited state as well as in the ground state. This may open new configuration possibilities for halo neutrons in ^{11}Li being coupled to 1^+ or 2^+ , while the halo neutrons are usually considered to couple to 0^+ with the ^9Li core in its ground state. The shape and magnitude of the measured angular distribution is highly sensitive to the three-body wavefunction. The curves shown in Fig. 3.1.4 are calculated with three- body wavefunctions based on the Fadeev model. It is seen

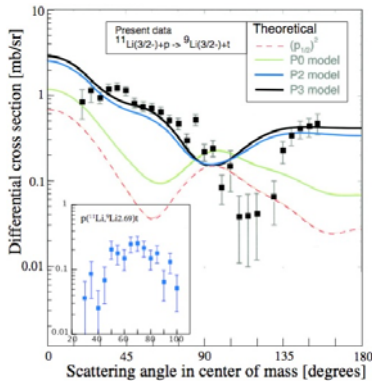

Fig. 3.1.4. The angular distributions for the $p(^{11}\text{Li},t)^9\text{Li}_{\text{gs}}$ (black squares) and the $p(^{11}\text{Li},t)^9\text{Li}^*_{2.69}$ (inset, blue squares). The solid curves are calculations with the P0/P2/P3 model having 3%/31%/45% s-wave including n-n correlation. The dashed curve shows uncorrelated neutrons in the $p_{1/2}$ orbital.

that the description of ^{11}Li with two uncorrelated neutrons in the $p_{1/2}$ orbital does not reproduce the data. The observations are consistent with a strongly mixed configuration with the intruder s -orbital and the p -orbital with strong correlation between the two-neutrons. A very recent analysis of the data with nuclear field theory shows that the two-neutron transfer to both the ground state and excited states of ^9Li provides the first direct evidence of phonon mediated pairing.

Highlight 5. ^{11}Li β -decay studies

In keeping with the recurring theme of halo nuclei, the beta decay of ^{11}Li itself is a way to probe the structure of $^{11,10}\text{Be}$ for circumstantial evidence of halo properties in excited states. This decay has the property that in the beta-neutron-gamma decay cascade, the gamma rays have a Doppler-broadened lineshape, from which lifetimes of excited states can be deduced. The 8π and SCEPTAR facilities, along with the world's most intense ^{11}Li beams, enabled high-statistics gamma-ray lineshape analysis and excited nuclear state lifetime measurements of a quality that will not be exceeded for at least a decade. The results of these studies can be compared to state-of-the-art models, and agree well with those calculations that simultaneously predict a halo nature for those states. This work was led by Colorado School of Mines in collaboration with Canadian scientists.

Topic 2: Modification of nuclear shell structure by extreme isospin

The success of the shell model applied to atomic nuclei is due to the existence of a set of “magic” numbers corresponding to particularly stable proton and neutron configurations in nuclei along, or close to, the line of β stability. However, for certain exotic nuclei new magic numbers appear while the established ones disappear. The migration of magic numbers of the nuclear shell model has been predicted for years, and recently more evidence has been found, mostly based on direct measurements with very rare exotic beams. A major research program at TRIUMF is the exploration of how the shells evolve as one moves away from the line of stability. Major changes in the locations of the shells have been linked to the underlying interaction of the valence protons and neutrons, and understanding this mechanism is of vital importance.

Highlight 6. Two-neutron separation energies from mass measurements with TITAN

An appearance of new or the migration of well known magic numbers can be investigated from two-neutron separation energies (S_{2n}), which are defined as the binding energy of a nucleus minus the binding energy of a nucleus with two fewer neutrons. A change in the linear behavior S_{2n} for a series of isotopes provides a direct evidence of the appearance of a closed neutron shell. At the shell gap there is a sudden increase in the (S_{2n}), corresponding to the enhanced binding across the shell gap, and it's worthwhile to note that this is exactly the same observation that led to the initial discovery of the magic numbers in nuclear physics. On the left, Fig. 3.1.5 shows the measured mass values in the form of mass excesses (ME) from direct measurements at TITAN compared to literature evaluations taken from the AME 2003. On the right the S_{2n} values are shown for K and Ca isotopes. The Ca isotopes in particular are of great interest due to recent theoretical predictions for magic numbers at various locations near neutron number $N=34$, where the

predicted location depends on the theoretical potential or interaction employed. This makes the experimental searches not only important as a discovery tool for new phenomena but allows direct comparison to existing theoretical calculations where magic numbers for $N=28, 32, 34$ are considered. The experimental data at this point show no indication that $N=34$ is a magic number, but further studies are needed to extend the findings to more neutron rich isotopes.

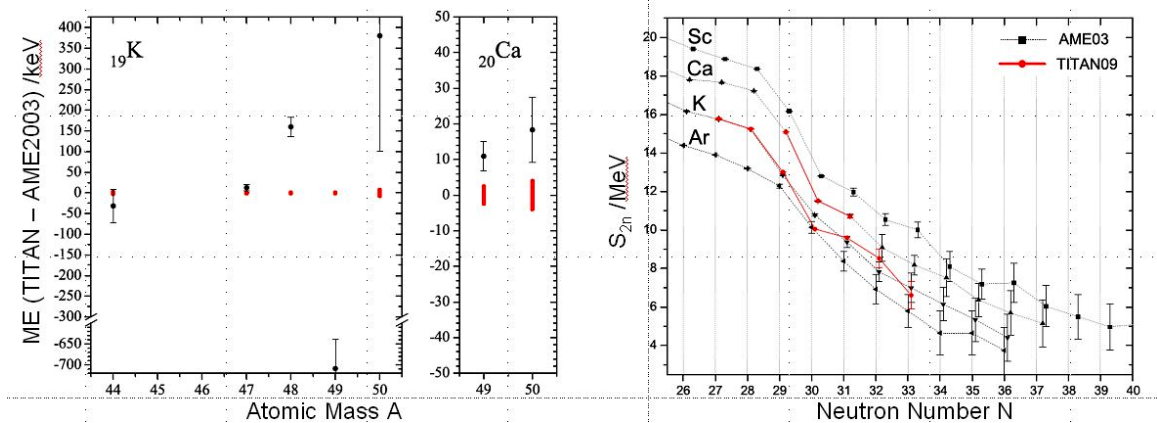

Fig. 3.1.5. Left: mass values for K and Ca isotopes as derived from TITAN measurements, and compared to the literature. Right: S_{2n} -values as a function of neutron number.

Highlight 7. ^{29}Na Coulex measurement with TIGRESS at ISAC-II

Nuclei in the so-called “Island of Inversion”, centered in the vicinity of ^{32}Mg , have been the focus of much research worldwide. A key TRIUMF contribution to these studies comes from the Coulomb excitation of ^{29}Na that was performed in order to understand the boundaries of the region where a major change in shell structure is observed. The Coulomb excitation of ^{29}Na was achieved using a beam of ^{29}Na accelerated using ISAC-I and ISAC-II. Excitation of both projectile and target was observed in the experiment. Determination of the transition matrix element $\langle 5/2^+ || E2 || 3/2^+ \rangle$ for ^{29}Na was accomplished according to the relative γ -ray yield between ^{110}Pd and ^{29}Na . The experimental result, $|\langle 5/2^+ || E2 || 3/2^+ \rangle| = 0.237(21)$ eb, is consistent with the prediction of the Monte Carlo shell model using the SDPF-M interaction of 0.232 eb, which also predicts the correct ground-state spin $I=3/2^+$ for ^{29}Na . This result supports the theoretical conjecture that allows for neutron excitations across the shell gap, resulting in neutrons filling the next major pf shell before completion of the $N=20$ sd major shell, and that it is a strongly-mixed state comprising a 30–40% admixture of $2p-2h$ configurations in the wave function. This scenario would imply a narrow sd - pf neutron-shell gap of ~ 3 MeV for ^{29}Na , much smaller than the value observed near stability.

Highlight 8. The new magic number $N=16$: ^{24}O , a new doubly magic nucleus at the drip-line

A spherical shell closure at $N=16$ would require the valence neutrons to be located exclusively in the $2s_{1/2}$ orbital with no strength in the d -orbitals. The longitudinal momentum distribution from knockout of one neutron from the drip-line nucleus ^{24}O is a

sensitive tool to determine the single particle orbitals in ^{24}O . This was investigated using the relativistic beams at 900A MeV at GSI. The observed distribution shows firm evidence of the neutrons being almost solely in the $2s_{1/2}$ orbital with no appreciable strength in the neighbouring d -orbital (Fig.3.1.6). This establishes ^{24}O as an unexpected new doubly magic nucleus at the neutron drip-line. As one moves towards more stable $N=16$ isotones the strength in the s -orbital decreases showing the absence of $N=16$ magic number close to the line of stability.

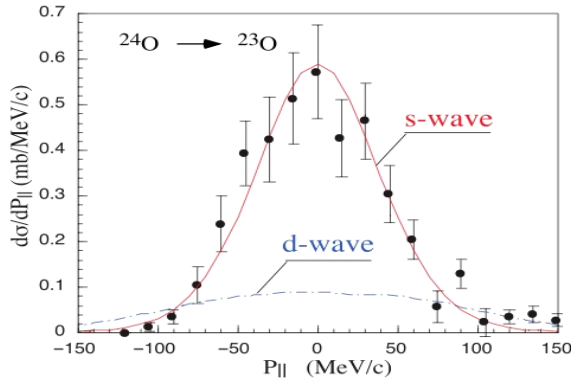

Fig. 3.1.6. The longitudinal momentum distribution data (dots) for one-neutron removal from ^{24}O . The red (blue) curves show theoretical predictions for the neutron being removed from the s - (d -) orbital.

Topic 3: The collective excitations in Cd nuclei

The idea that the atomic nucleus has deformable, droplet-like degrees of freedom has been a tenet of nuclear structure ever since Bohr and Kalckar provided an explanation of nuclear fission. Aage Bohr and Ben Mottelson developed this fundamental insight into the collective model, one of the foundational models of nuclear structure. While the modeling of nuclear collective degrees of freedom has evolved far beyond the original formulation of Bohr, the basic idea that the nucleus is a deformable liquid drop and therefore possesses quantized surface vibrational modes has remained a robust belief among nuclear physicists.

The Cd isotopes have stood out as some of the best examples of vibrational motion, or in the language of the Interacting Boson Model (IBM), at the $U(5)$ symmetry limit, being cited by Bohr and Mottelson and Arima and Iachello, as prime examples. Because they are structural paradigms, the Cd isotopes have been the subject of many investigations. Nearly all of these have used the vibrational framework to explain the observed data. When additional levels in the vicinity of the two-phonon triplet were observed, these were explained as intruding $2p$ - $4h$ excitations caused by the promotion of a pair of protons across the $Z=50$ closed shell. Due to enhanced proton-neutron correlations, the intruder excitations form more-deformed structures, and after taking into account the mixing with the spherical levels, the underlying vibrational interpretation of the “normal” phonon states was not questioned. In fact, a survey of possible $U(5)$ candidates found that the Cd isotopes were still the best examples.

In the past 5 years, significant effort has been extended towards complete spectroscopy of the even-even Cd isotopes using the powerful $(n,n'g)$ reaction. The results for $^{112,114}\text{Cd}$, revealed serious discrepancies with the IBM-2 calculations near the spherical $U(5)$ limit.

Further work on $^{110,116}\text{Cd}$ has shown that these discrepancies are not isolated but appear systematically. As deviations from the vibrational model have been attributed to mixing effects, the fact that these deviations appear systematically across an isotope chain, where energies between the excited states are continuously changing, would imply that various mixing matrix elements would also need to be changing in a very precise manner so as to cause certain transition matrix elements to vanish – an unrealistic scenario. The conclusion is that the Cd isotopes – our best examples of spherical vibrational motion – can no longer be considered as spherical vibrators.

Using the 8π spectrometer at TRIUMF-ISAC, a programme of β -decay experiments with very high statistics populating the Cd isotopes has been undertaken to complement the (n,n' γ) reaction results and provide precise measurements (or limits) on very weak γ -ray branches from highly excited states. Thus far, the studies of ^{110}In and $^{112}\text{In}/^{112}\text{Ag}$ β -decay have been performed. An analysis concentrating on the three-phonon 0^+ candidate in ^{112}Cd , important as a possible daughter for the neutrinoless double-electron capture of ^{112}Sn , revealed that it did not decay to the assigned two-phonon 2^+ state, in contradiction to expectations and theoretical calculations. An extended analysis of all 0^+ and 2^+ states up to 3 MeV in excitation reveals the lack of expected three-phonon B(E2) strength from these levels.

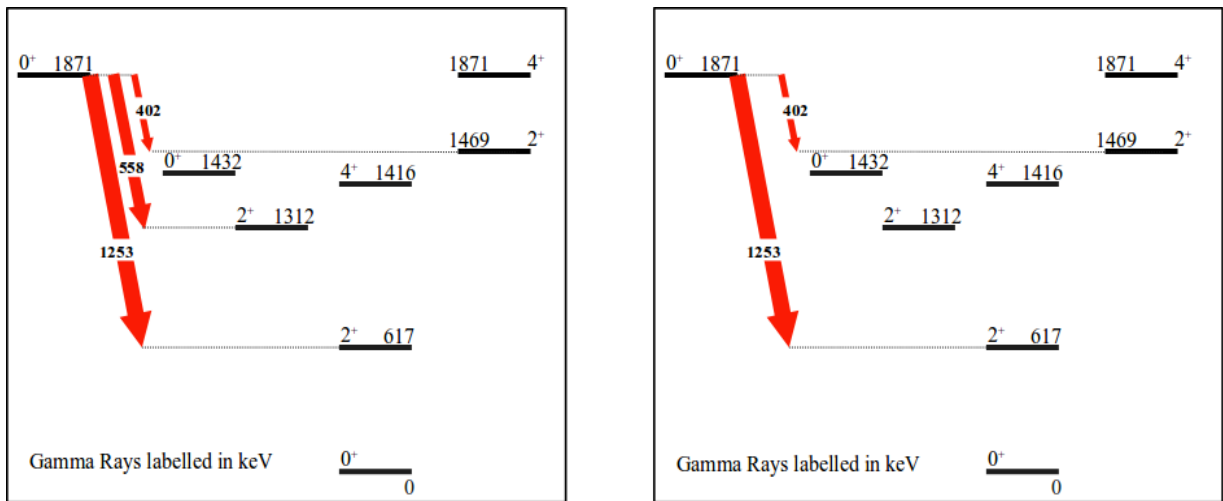

Fig. 3.1.7. Previous decay scheme of the 0^+ state at 1871-keV (left) compared with the results of the β -decay study performed with the 8π spectrometer at TRIUMF-ISAC (right). Note the absence of the 558-keV $0^+ \rightarrow 1312$ -keV 2^+ transition, for which an upper limit on the branching ratio of $< 5\%$ is established, that rules out a three-phonon interpretation for the 1871 keV 0^+ level.

Topic 4: Charge radius measurement of unstable ^{74}Rb

This has been seen by the direct observation of the energy and strength of E0 transitions in conversion electron spectroscopy in Kr. ^{74}Rb is a spin 0 nucleus in its ground state and therefore has no measurable static deformation however, as laser spectroscopy reveals changes in the mean square charge radii any dynamic deformation will be seen as an increase in the RMS charge radius. The two competing 0^+ configurations have been

predicted to have deformations of $\beta_2 = -0.35$ and $+0.41$. It can be shown that a change from one pure 0^+ state to the other would result in a change in $\langle r_{\text{ch}}^2 \rangle$ of 0.37 fm^2 , implying a change in $\langle r_{\text{ch}} \rangle$ of 0.04 fm which is approximately 1%.

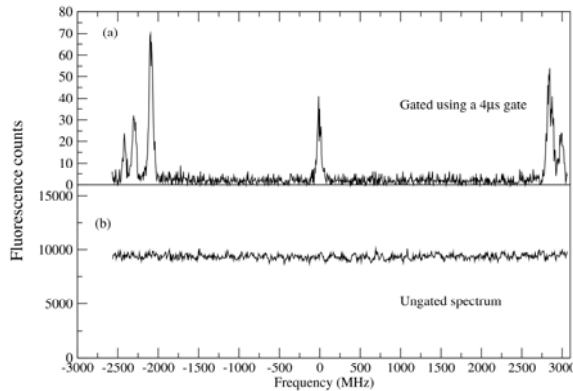

Fig 3.1.8. Fluorescence from bunched $^{78,78\text{m}}\text{Rb}$ beam following Doppler-free absorption from the co-linear laser setup with (top) and without (bottom) a timing coincidence condition between the RF bunching frequency and the photon detector.

The first steps towards this measurement have been made by successfully performing laser resonance spectroscopy on a beam from ISAC that was stopped, cooled and bunched using the TITAN radio frequency quadrupole (RFQ) cooler buncher. Here the beam from ISAC is injected into the cooler and buncher and collected for several tens of milliseconds. The collected sample is then stored in the gas filled RFQ for a further few ms in order to cool the ions via collisions with the buffer gas before being ejected into a collinear laser spectroscopy line as a short burst of approximately $2 \mu\text{s}$ duration. The advantage of this is that the background that normally dominates this type of measurement is reduced by the duty cycle of the beam pulses. In the recent measurement of ^{78}Rb , $^{78\text{m}}\text{Rb}$ at ISAC this enhancement was approximately 4 orders of magnitude, see Fig. 3.1.8. This demonstrates that the technique has the required sensitivity for the more challenging ^{74}Rb measurement.

3.1.2 Experimental facilities needed for this work

On the experimental side, two major recent milestones have advanced research in nuclear structure: accelerator facilities which provide experimental access to intense mass-selected (isotope-selected) beams with lifetimes down to the microsecond scale and large arrays of detectors with extraordinary data-collecting power. The combination of these two capabilities marks a unique, major advance in nuclear physics that has not been seen in a number of decades. Developments in both areas were driven to large extent by the Canadian community as documented below.

3.1.2.1 ISAC facility at TRIUMF, a premiere tool for nuclear structure research

The Isotope Separator and Accelerator (ISAC) located at TRIUMF in Vancouver, Canada, is the world's most powerful radioactive ion beam facility of the isotope separator on-line (ISOL) type. A major expansion of the ISAC facility began operation in

2007 when the new ISAC-II superconducting linear accelerator delivered its first accelerated radioactive ion beam to an experiment. The online operation of the ISAC charge-state booster, and the completion of the ISAC-II high-acceleration cavities, will further extend the range of nuclear masses that can be accelerated from $A = 30$ to $A = 150$, and the maximum energy to between 6.5A MeV and 15A MeV.

The Canadian community has invested heavily in experimental capabilities at ISAC and has started to reap considerable benefits. Specifically, it is at TRIUMF-ISAC that the most intense mass-separated beams ever have been used for experimental studies. Some of these studies have used the 8π and TIGRESS arrays of detectors that are among the most advanced, in their respective deployment, ever applied to nuclear structure studies. In addition, at TRIUMF-ISAC highly competitive experimental capabilities for trapping and characterizing rare isotopic species, such as TRINAT and TITAN and for investigating reactions produced by secondary beams of these species, such as DRAGON, TUDA and TACTIC have been built.

During the tenure of the current Long Range Plan the TRIUMF facility will enter the era of exploiting the investments of the past 5 years as well as developing new experimental capabilities: routine operation of actinide targets, a second proton beam line for ISAC, and ARIEL, a new electron accelerator for radioactive beam production through photo-fission of uranium. In particular, the new ISAC actinide production target, which successfully underwent its first online tests in the past two years, will provide access to both the actinide beams required by the fundamental symmetries program and the extremely neutron-rich beams of key interest to the nuclear structure and astrophysics program. This greatly expanded range of isotopes and energies available at ISAC will ensure Canada's continued leadership role in the emerging field of radioactive ion beam research, which has been identified as among the highest priorities of the Canadian subatomic physics community in the previous NSERC Long-Range Plan, "Perspectives on Subatomic Physics in Canada 2006–2016".

3.1.2.1.1 The 8π spectrometer

The 8π gamma-ray spectrometer was built in 1985 by a team of Canadian physicists. It consists of 20 High Purity Germanium (HPGe) detectors used to measure very precisely the energy of one or more gamma rays emitted by atomic nuclei. Originally operated at Chalk River and later Berkeley for in-beam studies, the 8π was relocated to TRIUMF in 2001 to serve as the premier decay spectrometer of ISAC-I. In the decade since this, a series of ancillary detector systems have been developed to optimize the spectrometer for its current role at ISAC. The physics program with the 8π at ISAC-I has expanded continuously with the evolving capabilities of the spectrometer and currently supports 22 separate experimental proposals approved by the TRIUMF EEC. The ancillary detector systems, which include:

- an in-vacuum moving tape collector system,
- a 20-element plastic scintillator beta detector array, SCEPTAR
- a 5-element Si(Li) conversion electron spectrometer, PACES and

- a 10 element BaF (or LaBr₃) fast gamma-ray timing array, DANTE

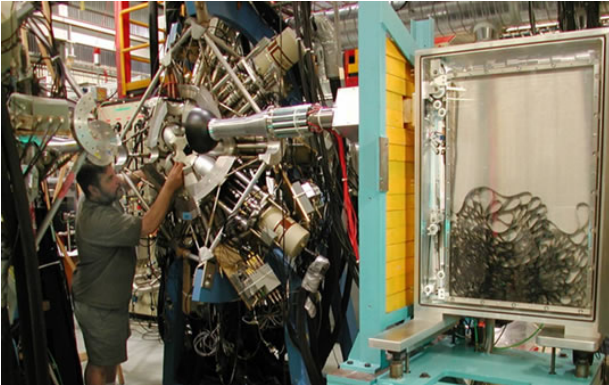

Fig. 3.1.9. The 8π spectrometer, SCEPTAR and the moving tape system.

These ancillary systems combine to make a unique facility for high-efficiency gamma-beta-conversion electron coincidence decay studies which is currently unrivalled in the world for such decay studies with low-energy radioactive beams, see Fig. 3.1.9.

The 8π data acquisition system, based on analogue electronics, has been developed to maximize the versatility of the spectrometer for a wide variety of nuclear physics investigations. In nuclear structure experiments the highest through-put of data is required to collect high statistics for the detailed characterization of nuclear decays. The system also incorporates a large degree of accountability in every aspect of the data collection and processing. This is vital for the high-precision half-life and branching ratio measurements performed in the fundamental symmetries program.

3.1.2.1.2 The TIGRESS spectrometer

The TRIUMF-ISAC Gamma-Ray Escape Suppressed Spectrometer (TIGRESS) is a state-of-the-art gamma-ray spectrometer designed for a broad program of nuclear structure and nuclear astrophysics research with the accelerated radioactive ion beams now being provided by the ISAC-II accelerator at TRIUMF. The radioactive ion beams delivered by ISAC-II are accelerated to energies (continuously variable between 1.5 and 6.5 MeV/nucleon for heavy nuclei and higher for light nuclei) sufficient for them to undergo Coulomb excitation, nucleon transfer, and/or nuclear fusion reactions in thin foils supported in a reaction chamber at the centre of the TIGRESS spectrometer. The gamma rays emitted by the excited atomic nuclei produced in these reactions are measured by TIGRESS to study the structure of the nucleus and the forces which hold it together.

TIGRESS design, development, and installation was supported by an \$8.06M Research Tools and Instruments grant awarded by NSERC in 2003-2009 to a collaboration of researchers from across Canada (the University of Guelph, Université Laval, McMaster University, Université de Montreal, Simon Fraser University, University of Toronto, and TRIUMF). TIGRESS is now operational and is used in a wide range of experiments at ISAC-II.

The "heart" of the TIGRESS spectrometer is an array of 16 high-purity germanium (HPGe) clover-type detectors. Each of the four large HpGe crystals in a TIGRESS detector has 9 separate electrical contacts, one inner core contact which provides the high-resolution measurement of the total energy deposited in the crystal as well as 8 outer segment contacts which provide information on the location of the gamma-ray interaction within the crystal. Each clover is surrounded by a segmented Compton-suppression shield formed of high-efficiency scintillator crystals of bismuth germanate (BGO) and cesium iodide (CsI). These shields detect gamma rays that scatter out of the HPGe crystals without depositing their full energy. Such information is used to veto these unwanted events and improve the peak-to-background ratio of the gamma-ray spectra recorded by TIGRESS.

All of the TIGRESS detector signals are continuously digitized 100 million times per second (100 MHz) in custom-designed 14-bit 10-channel (TIG-10) waveform digitizer modules. The detailed analysis of these digitized waveforms from the HPGe allows the gamma-ray interaction location to be determined with much finer resolution than the physical size of the detector segments. An average position sensitivity for single gamma-ray interactions of 0.44 mm has been achieved through these techniques. The ability to pin-point the gamma-ray interaction locations within the TIGRESS detectors enables accurate correction of the measured gamma-ray energies for the Doppler shifts inherent in experiments with ion beams accelerated to several percent of the speed of light, while still allowing each HPGe crystal to subtend a large solid angle about the reaction point at the centre of the spectrometer. TIGRESS thereby attains the excellent gamma-ray energy resolution that is the defining feature of HPGe detectors, while simultaneously achieving the very high gamma-ray detection efficiency required for experiments with accelerated radioactive ion beams.

As shown in Fig. 3.1.10 the mechanical design of the TIGRESS support structure enables the rapid reconfiguration of the entire spectrometer between a "maximum efficiency" configuration in which the HPGe detectors are close-packed at an 11.0 cm radius from the reaction centre, and an "optimal peak-to-background" configuration in which the HPGe detectors are withdrawn to 14.5 cm and the BGO front shields are inserted radially to form a full Compton suppression shield around each HPGe detector.

In both configurations of the TIGRESS array, an inner sphere of 11.0 cm radius is available to accommodate the auxiliary detection systems necessary to detect reaction products in coincidence with the gamma rays measured by the surrounding TIGRESS



Fig. 3.1.10. Part of the TIGRESS spectrometer in the “maximum efficiency” (left) and the “optimal peak-to-background”(right) configuration.

detectors. The initial experiments with TIGRESS at ISAC-II were performed with the segmented Si CD detectors of the Bambino array developed by collaborators at Lawrence Livermore National Laboratory and the University of Rochester in the United States. Since 2009 the Silicon Highly-segmented Array for Reactions and Coulex (SHARC) developed by collaborators from the University of York in the United Kingdom and Louisiana State University and Colorado School of Mines in the United States, has been employed in its first experiments with TIGRESS. SHARC is one of the most advanced detector systems of its kind and represents an almost 4π solid-angle coverage with less than 1 degree angular resolution and typically better than 25keV energy resolution for charged-particle and heavy ion detection. The powerful coupling of the TIGRESS and SHARC devices forms the most sensitive instrument currently operating anywhere in the world for Coulomb excitation and transfer reactions with ISOL produced radioactive beams.

Additional detectors which are being constructed for operation with TIGRESS at ISAC-II include the DESCANT neutron detector array under development at the University of Guelph, the ElectroMagnetic Mass Analyser (EMMA) being developed at TRIUMF, the TIGRESS Integrated Plunger (TIP) being developed at Simon Fraser University, and the SPectrometer for Internal Conversion Electrons (SPICE) being developed at TRIUMF. These combined systems will provide a powerful new facility to pursue nuclear structure, nuclear astrophysics, and nuclear reactions research with the high-quality accelerated radioactive ion beams from ISAC-II through the detection of light charged particles, neutrons, and heavy ion recoils in coincidence with the gamma rays measured by TIGRESS.

3.1.2.1.3 The TITAN ion trap

TITAN (TRIUMF's Ion Trap for Atomic and Nuclear science) is a unique multi-ion trap system installed at the radioactive ion beam facility ISAC. TITAN is designed to carry out mass measurements of very high precision, with $\Delta m \approx 1$ keV, (or $\delta m/m < 1 \cdot 10^{-8}$) even for isotopes with short half-lives ($T_{1/2} \approx 10$ ms) and for isotopes very far from the

valley of stability, hence with low production yields. After only a few years of on-line operation TITAN has set new standards of performance for ion traps. For example, ^{11}Li is the shortest lived isotope ever weighed in a Penning trap ($T_{1/2}=8.6\text{ms}$), and was measured to a precision of $\delta m = 660 \text{ eV}$. ^8He is the most exotic isotope ever investigated, and TITAN was able to measure its mass. The sensitivity of TITAN could be demonstrated with recent on-line runs of Be and neutron rich Ca and K isotopes, where measurements were possible at isotope beam intensities of a few tens per second. With these proven capabilities and proposed improvements TITAN is geared up to reach the required precision for the mass measurements of the different high priority experimental programs. Key to the success of TITAN are its fast beam preparation and measurement cycle, and its unique capability to go to higher charge states. This latter feature is important to achieving high precision with a relatively short measurement time. In addition, the coupling of TITAN to ISAC as a source of some of the most intense radioactive beams of very exotic nuclei worldwide provides excellent experimental opportunities. ISAC has been operational for more than 10 years, and has demonstrated its capability to deliver a broad variety of radioactive species with sufficient production yields, which for TITAN can be as low as a few ions/second. The ISAC target materials for the production of the exotic isotopes include now also U (UC or UO) and ISAC has brought a suite of ion sources (surface, laser, ECR, FEBIAD) online.

Fig. 3.1.11 shows a photo and the schematic set-up of the TITAN system at ISAC. TITAN consists presently of three, and will be expanded in 2011 to four main components; 1. a gas-filled linear radio-frequency quadrupole (RFQ) ion trap (RFCT), for cooling and bunching the radioactive beam, 2. an electron-beam ion trap (EBIT), for charge-stage boosting, 3. Penning ion-trap for mass determination (MPET), 4. a cooler Penning ion trap (CPET), between EBIT and MPET for beam quality enhancement. In addition there are also off-line test ion sources, below the RFCT and in the EBIT beam line.

The core piece of the TITAN setup is the Penning trap mass spectrometer. Penning traps are the most precise devices to measure masses reaching an accuracy of $\delta m/m < 10^{-12}$ for stable species. The precision of the mass measurement in a Penning trap is given by the inverse of the excitation time T_{RF} , and for TITAN the following applies:

$$\frac{m}{\delta m} \propto \omega_c T_{RF} \sqrt{N} = \frac{qB}{m} T_{RF} \sqrt{N}$$

where N is a statistical factor, B is the magnetic field strength, q/m is the charge-to-mass ratio. Hence the precision is therefore directly proportional to the charge state of the ion q . Ideally, one would try to increase the excitation time as much as possible. However, this is limited in the case of short-lived isotopes by the decay half-life of the ion. Similarly, increasing the magnetic field will give an increase in precision, yet the improvement is limited by the current magnet technology. The TITAN setup is the first online system worldwide to utilize the significant increase in the charge q of the measured ion to improve the accuracy. Fig. 3.1.12 shows the relative accuracy of Penning

trap spectrometers as a function of measurement time, in sets of magnetic field strength B and charge state q of the ions for given statistics N and ions at mass 100 u.

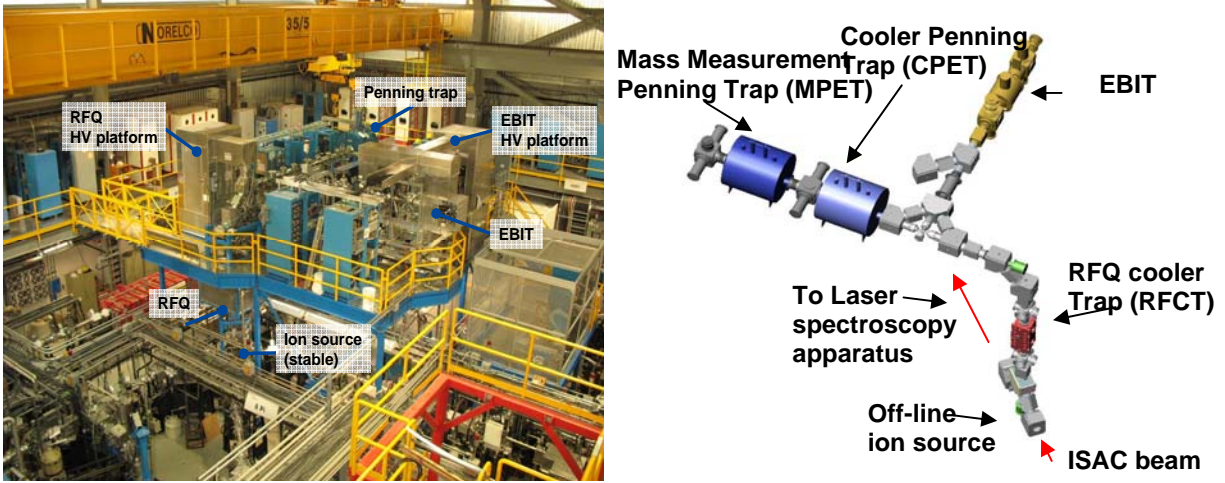

Fig. 3.1.11. Left: Photo of the TITAN set-up at ISAC, indicated is the Penning trap, the EBIT and the RF Cooler Trap on the photo. Right: schematic set-up of the complete TITAN set-up. The Cooler Penning trap is presently under construction.

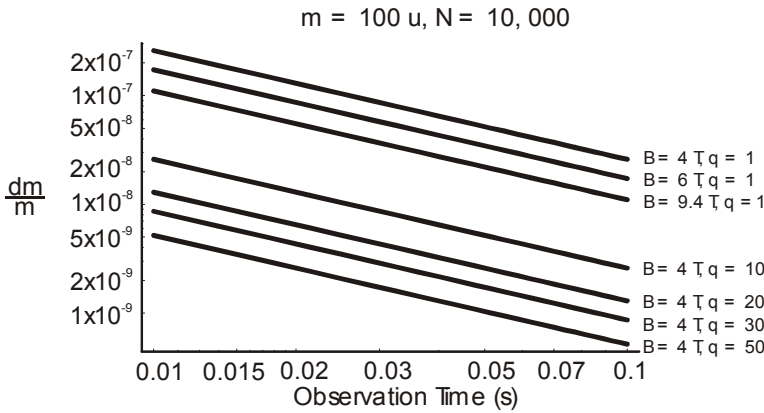

Fig. 3.1.12. Relative accuracy of the Penning trap measurement as a function of observation time. The different sets of graphs represent different charge states q and different magnetic field strength B . The case shown is for 10 000 measurement cycles

3.1.2.1.4 The Heracles spectrometer

Experimental evidence indicates that the nuclear potential includes a term of a significant strength that depends on the neutron-to-proton ratio in a nucleus. Unstable beams available at ISAC, when used as projectiles to generate nuclear collisions provide one of the best tools to investigate the dependence of nuclear interactions on the proton/neutron asymmetry. The projectiles at hand at ISAC differ by up to 50% in neutron-to-proton ratio, which in turn causes the products of nuclear reactions to emerge with variable but measurable probability. The detection facility which identifies those reaction products and measures their energy at ISAC-II is called Heracles. This multidetector system consists of nearly 80 detection units of various types mounted at variable angles

providing an almost complete identification of all particles produced in each event, allowing in turn a nearly full reconstruction of a history for each collision on an event-by-event basis. The detectors are plastic scintillators, CsI and BaF₂ crystals, and silicon crystals. The distribution of a particular detector type within the Heracles array is based on the detection properties of a unit, its capability to stop particles of different energies, charge and mass, as well as the unit's energy resolution. The analysis of data acquired from thousands of collisions allows the extraction of different distribution of physics observables which in turn are compared to theoretical predictions based on state-of-the-art models of nuclear collisions.

3.1.2.1.5 β -detected Nuclear Quadrupole Resonance (β -NQR) facility for quadrupole moment measurements

Over the past few years a significant effort has been applied at the ISAC facility to make use of the extremely successfully β -NMR experiment developed for the TRIUMF material science programme to enable precise measurements of nuclear quadrupole moments. The feature that makes this such an advantageous device is the ability to reduce the magnetic field in the vicinity of the sample to a few 100 nT. Therefore whilst in conventional β -detected NMR techniques the quadrupole interaction is observed as a perturbation on the magnetic dipole interaction here it is observed directly. This enables quadrupole moments to be extracted with an extremely high precision and has also allowed hitherto unseen systematic effects that are inherent to this type of measurement to be investigated.

In addition to the existing resources there are major infrastructure developments under construction or planned. The most significant are listed below.

3.1.2.1.6 The GRIFIN spectrometer

Gamma-Ray Infrastructure For Fundamental Investigations of Nuclei (GRIFFIN) is a future world class gamma-ray spectrometer for decay spectroscopy studies at ISAC-I that will increase the gamma-gamma coincidence detection efficiency by a factor of 300 over the current 8π gamma-ray spectrometer, which was constructed almost 25 years ago. GRIFFIN will enable full exploitation of the radioactive ion beams produced by ISAC (with intensities as low as 0.01 ions/s), and its upgrades via the new superconducting electron-linear accelerator and ARIEL facility. GRIFFIN will be comprised of 16 large-volume "clover-type" high-purity germanium (HPGe) gamma-ray detectors, each of which contains 4 large germanium single crystals as shown in Fig. 3.1.13. All of the detector signals from GRIFFIN will be continuously digitized 100 million times per second (100 MHz) and processed in custom-designed digital electronics modules capable of complete data readout from the array with each of the 64 HPGe crystals recording as many as 50,000 gamma-ray interactions per second.

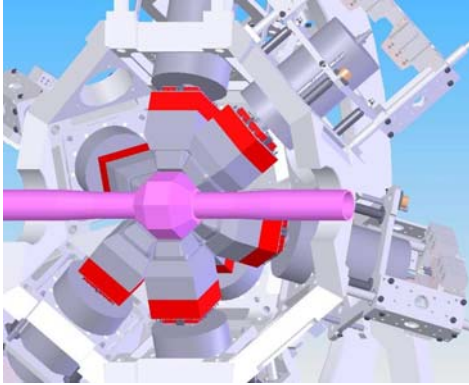

Fig. 3.1.13. Schematic of one hemisphere of the GRIFFIN gamma-ray spectrometer in its maximum efficiency configuration. The low-energy radioactive ion beam will be implanted in a thin foil in the middle of the central vacuum chamber, where the radioactive decays will take place.

GRIFFIN has been designed to incorporate all of the existing auxiliary detection systems currently operating with the 8π spectrometer; the moving-tape collector, SCEPTAR, PACES, DANTE, as well as being fully compatible with the new DESCANT neutron detector array under development at the University of Guelph.

The GRIFFIN project has been approved by the Canada Foundation for Innovation and, \$9,230,248 has been committed toward the project to date, which is sufficient to construct the full GRIFFIN spectrometer without the Compton-suppression shields. An additional \$2,237,764 is required to complete the GRIFFIN Compton-suppression shields. The ultimate outcome of the GRIFFIN funding applications will have a significant impact on the long-range plan for nuclear physics research in Canada over the next 5-10 years. A successful funding decision will make GRIFFIN one of the major new infrastructure developments in Canadian nuclear physics and will enable the community to fully exploit the major investments in the ISAC facility and its further upgrades to ARIEL in the next 5 years. Conversely, a negative outcome for the current GRIFFIN application through CFI will leave ISAC with a 25 year old detector facility to fulfill its decay spectroscopy program, a core component of any radioactive beam facility. This is an untenable situation that, within the next 5 years, would require a major (of order \$10M) capital funding request to NSERC. At the time of writing, the funding situation for the GRIFFIN project remains unknown, and hence both scenarios will need to be considered within the Long-Range Plan.

3.1.2.1.7 The EMMA spectrometer

A new class of structure experiments at ISAC-II will be enabled by a coupling of the upcoming Electro-Magnetic Mass Analyzer (EMMA) with TIGRESS and its auxiliary detectors. EMMA will separate the recoils of nuclear reactions from the radioactive beams and transport them to the back of the separator, the focal plane of EMMA. An array of detectors at the focal plane will allow for determination of mass and atomic number of the recoils using position, energy loss and time-of-flight information. These parameters are of crucial importance in identifying and studying exotic nuclei populated in very weak, outgoing channels embedded in a very high background. Gamma-ray detection is a critical component of this future research application of EMMA. Radioactive beams and new equipment present high innovation potential for TRIUMF researchers by enabling studies essential for elucidating the changes in nuclear structure

away from stability, ultimately impacting our understanding of the origin of elements in the Universe.

An example is provided by delayed gamma-ray spectroscopy at the focal plane of EMMA such as isomer studies and particle decay spectroscopy. A system including an implantation detector — typically a double-sided silicon strip detector (DSSD) used to measure the energy of the ions that are implanted and the α - and β -particles they subsequently emit — and a high-efficiency segmented clover Ge detector to measure the energies of high-energy gamma rays is envisioned to be applied for and constructed under the auspices of SFU. Such a system can either be used as a sensitive, stand-alone device for decay measurements at EMMA's focal plane or to provide selective tags for prompt gamma rays measured with an array of detectors at the target position. In the latter case, detectors can be used in different combinations at EMMA's focal plane, with their particular arrangement governed by the aims of individual experiments.

3.1.2.1.8 The IRIS solid hydrogen target facility

The ISAC reaction induced spectroscopy station, IRIS, is a new facility under construction for studying direct reactions by charged particle spectroscopy using the re-accelerated beams of rare isotopes with energies from 5-12.4 MeV provided by the ISAC-II facility at TRIUMF. The facility was recently funded by the Canada Foundation for Innovation (CFI) and is being developed in partnership with Japan by a Canada-wide collaboration involving Saint Mary's University, University of Guelph, Simon Fraser University, McMaster University and TRIUMF. It will pioneer in developing a thin solid hydrogen target (see Fig. 3.1.14) to boost the reaction yield, thereby allowing reaction studies of very neutron-rich nuclei possible, since they can only be produced with rather small intensity. Such a target is also necessary to eliminate backgrounds arising from the carbon content of polyethylene foils that are currently being used. A low-pressure ionization chamber is another new development in the facility that will make it possible to identify beam contaminants before reaction with the target. Arrays of segmented silicon strip detectors will detect the reaction products. These powerful innovative features make IRIS a major world-class facility in Canada that should play a significant role in the rare isotope science program in the Long Range Plan in the coming years.



Fig. 3.1.14. Solid hydrogen target cell under development. The cell is backed by a thin silver foil.

The first scientific program of IRIS will focus on certain key issues where the IRIS facility and ISAC can lead Canada to play a pioneering role internationally in the research of unstable rare isotope science. The study of pairing correlation in neutron halos and skins with two-nucleon transfer reaction is one of the major interests with IRIS. A strong program is planned for understanding the evolution of shell structure through the study of one-neutron transfer reactions in neutron-rich regions, since the appearance of exotic structures and shell structure are closely related. Neutron halos and skins in give rise to new modes of excitation, in particular soft dipole resonances that are expected to be neutron-unbound resonances and necessarily require charged particle spectroscopy for their detection. The detection of charged particles is the fundamental requirement to study nucleon transfer reactions.

3.1.2.1.9 The auxiliary detectors for TIGRESS: DESCANT, TIP and SPICE

Reactions above the Coulomb barrier using neutron-rich beams will produce copious amount of neutrons. For some experiments, such as those utilizing fusion-evaporation reactions, it will become necessary to obtain information about the evaporated neutrons, requiring the construction of a neutron-detector array. Furthermore, it will be of interest to obtain direct information on the neutrons emitted in reactions, as in the case of neutron-halo breakup reactions, in order to probe di-neutron correlations. For this purpose, a specially designed and constructed neutron detector array, DESCANT, is being built led by the University of Guelph.

DESCANT will be a 70-element array based on deuterated liquid scintillator. Funding for the \$1.8M project was obtained through the CFI and the Ontario MRI. The detector elements are being constructed by St. Gobain, and were designed at the University of Guelph. Using both the pulse height and time-of-flight information, this innovative array will use custom-built 1GHz waveform digitizers compatible with the “TIG” standard used in the TIGRESS spectrometer, and will represent the most advanced fast-neutron detector array in the world. Designed to be coupled to TIGRESS for experiments at ISAC-II, it will also be possible to couple DESCANT to the newly proposed GRIFFIN array (see below) for beta-delayed neutron emission studies.

The prototype detector, shown in Fig. 3.1.15, was received in June 2010 and was evaluated at the University of Kentucky accelerator facility. The prototype met or exceeded all performance measures, and achieved a timing resolution for ^{60}Co γ rays of <1 ns FWHM. The detector also had impressive discrimination between neutrons and γ rays, exceeding that of many normal scintillators. Manufacture of the production units has commenced, and the array is expected to be completed and ready for commissioning experiments in spring 2012.

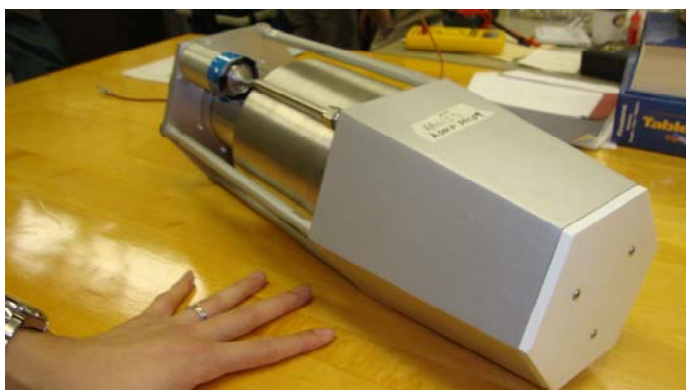

Fig. 3.1.15. Photograph of a DESCANT prototype detector. The detector scintillator can has a depth of 15 cm, and is filled with deuterated benzene liquid scintillator.

The TIGRESS Integrated Plunger (TIP) provides means for implementation of the Recoil Distance Method for picosecond lifetime measurements of gamma-ray decaying nuclear states utilizing the TIGRESS array at ISAC-II. In the TIP set-up the plunger device for micrometer positioning of a reaction target with respect to a stopper of recoil products is coupled to a $\sim 4\pi$ CsI array for identification of protons and α -particles evaporated during cooling of a compound nucleus formed in a fusion-evaporation reaction. Both, the plunger and the CsI ball of the TIP project were funded by separate NSERC grants and are being built in collaboration between Simon Fraser University, St. Mary's University and TRIUMF. TIP is planned to be first deployed in 2011 for studies of shape evolution and coexistence along the $N=Z$ line between doubly magic ^{56}Ni and ^{100}Sn .

The SPectrometer for Internal Conversion Electrons (SPICE) is a future ancillary detector to be coupled to the TIGRESS array. The spectrometer consists of a permanent magnetic lens which collects and transports internal conversion electrons to a set of semiconductor detectors located in vacuum. SPICE will have a unique ability to efficiently detect high-energy (0.1-4MeV) internal conversion electrons making it the ideal tool for the investigation of shape coexistence and shell evolution in exotic nuclei through the observation of $E0$ electron transitions following nuclear reactions. The project is fully funded (\$312,208) by a CFI grant with matching funds from the Ontario MRI. Construction will begin in 2010 and the first experiments will be performed in 2011.

3.1.3 International collaborations and Canadian-driven programs in foreign laboratories

The high impact of the Canadian nuclear structure community world-wide is further represented by a number of cutting-edge programs driven by Canadians in laboratories

outside the country. These programs, as listed below, address the fundamental physics questions outlined in the introduction by performing experiments which may not necessarily be possible at TRIUMF. While details are explained in corresponding subsections, the synergy of the world-wide effort should be emphasized here. Taking advantage of a range of probes which differ in mass, charge, and energy, at TRIUMF and elsewhere, the Canadian nuclear structure community continues the effort of pursuing the most fundamental scientific questions in optimal and the most advanced way.

3.1.3.1 Canadian Penning Trap (CPT) at Argonne National Laboratory

Since 2001, the Canadian Penning Trap (CPT) mass spectrometer, originally constructed for use at the TASCC facility of the AECL Chalk River Laboratories, has been operational at the ATLAS facility of the Argonne National Laboratory. Canadian physicists from Manitoba and McGill (4 NSERC eligible investigators, 1.5 post-docs and 2 graduate students from Canada) use this facility. They are joined by collaborators from ANL, Northwestern University and LBL. The CPT has been used for the measurement of super allowed beta decay q-values for CKM matrix unitarity tests, double-beta decay q-values and atomic masses and Q-values that determine the rates and paths of the astrophysical r- and rp- processes. The isotopes are produced in fusion evaporation reactions or in the fission of (100 mCi) ^{252}Cf and are captured, in-flight, in a precision Penning trap. This allows the study of a diverse range of short-lived nuclides independent of their volatility or chemical properties. These studies are complementary to those with TITAN at ISAC because the solid-target/diffusion technique applied at ISAC traditionally excludes involatile species.

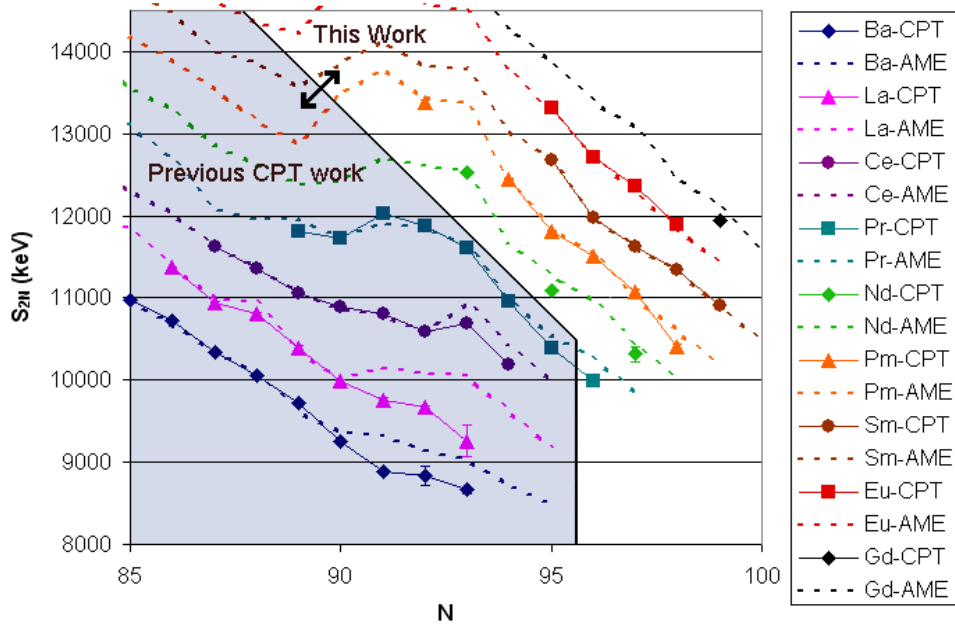

Fig. 3.1.17. S_{2n} values for neutron rich isotopes. The dotted lines represent the predictions of the AME 03 and the symbols represent the measured values from the CPT.

The CPT has been used to measure the masses of a number of neutron-rich nuclei produced in the fission of ^{252}Cf . These results increase the precision with which the masses are known in this region far from stability and show significant differences from the values predicted by the Atomic Mass Evaluation. A plot of the S_{2n} values derived from these measured masses reveals the known region of deformation around $N=92$ and illustrates its evolution and eventual disappearance for the lanthanum isotopes.

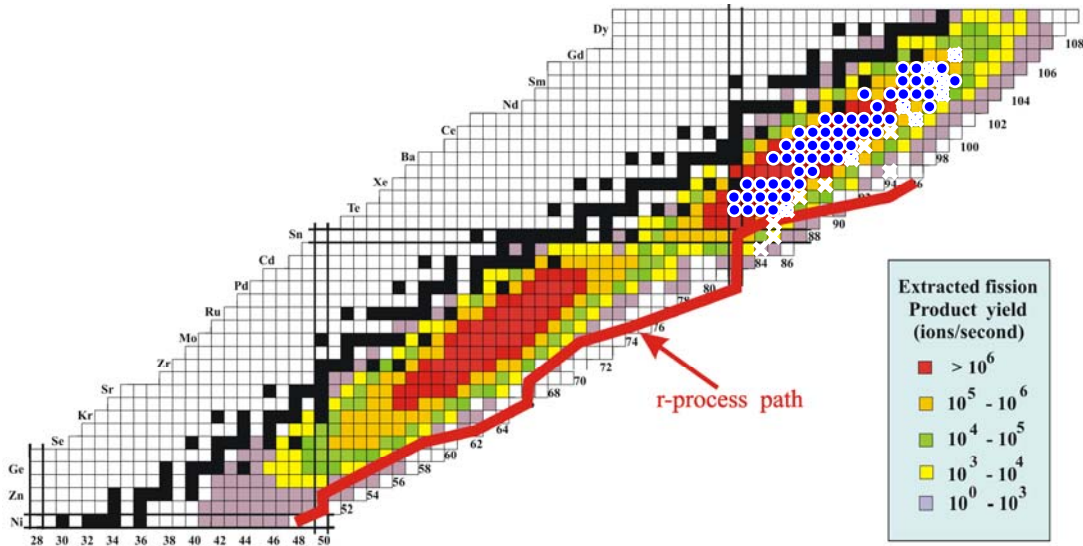

Fig. 3.1.16. Nuclides produced by ^{252}Cf fission. Blue circles and white crosses represent nuclides whose atomic masses have been determined with the CPT mass spectrometer

The addition of the Californium Rare Isotope Breeder Upgrade (CARIBU) at the ATLAS facility will exploit this technique and scale up the strength of the ^{252}Cf source currently used at the CPT to an appreciable fraction of a curie greatly extending the range of nuclei far from stability that can be reached by the CPT. The CPT has been moved to a new beamline that will allow it to directly access the neutron rich nuclei from CARIBU for measurements. It is also planned to inject and accelerate the CARIBU ion beam using the existing ATLAS accelerator and use these very neutron rich projectiles for nuclear structure and astrophysics measurements. After exhausting the possibilities with ions derived directly from CARIBU (in about 2 years), we plan to move the CPT once more to a new location that will allow us to exploit the potential of these new, neutron-rich beams from ATLAS.

3.1.3.2 Reactions with relativistic beams at GSI

The rare isotope beams produced through in-flight fragmentation at the Helmholtzzentrum für Schwerionenforschung GmbH (GSI), Darmstadt, Germany are the highest energy rare isotope beams in the world with maximum energy currently reaching 1A GeV. These relativistic beams offer a quite different scope of studying the exotic nuclei that are not possible using the low-energy beams at TRIUMF. Two of the major

research programs where Canada is playing a leading role in this facility are described below.

Topic 1: Changes in shell structure through nucleon removal reactions

The concept of nuclear shell structure is one of the basic foundations of nuclear science. The greatest success of the shell model is the explanation of the magic neutron and proton numbers, where nuclei exhibit stronger binding. This handful of nucleon numbers (found to be same for neutrons and protons) are of great importance in nuclear physics and nuclear astrophysics. The extra stability at magic numbers leads to a large abundance of these nuclei during nucleosynthesis in the r and s processes. Interestingly, studies around the line of stability showed that the nucleon magic numbers were always the same for different elements. However, the access to nuclei with a large excess of neutrons over protons (or vice versa) is now leading us to find that the conventionally magic numbers are not universal. Magic numbers change because of the migration of nuclear orbitals. How and why the orbitals migrate is an ongoing research topic of great importance world-wide.

The relativistic beams at GSI allow us to look into the valence neutron orbitals by removing the outermost (one or two) neutrons in an instantaneous impact with a light target nucleus (such as carbon). The energy needs to be high enough to ensure that while removing the neutron, the remaining part of the projectile behaves as a spectator. In this sudden approximation limit, which is best fulfilled at energies greater than few hundred A MeV the shape of the momentum distribution of the fragment is directly connected to the wavefunction and hence orbital of the knocked out neutron. Following are some recent explorations of neutron knockout reactions that made a notable impact.

An unexpected new doubly magic nucleus (^{24}O) was recently established that lies at the extreme edge of stability in the isotopic chain of oxygen isotopes. This new magic number at N=16 is found only in very neutron-rich isotopes. It is important to also note that the conventional magic number at N=20 seems to have disappeared in these regions, due to which the expected doubly magic isotope (^{28}O) does not exist. The new doubly magic nucleus ^{24}O can now serve as a benchmark point for new structure models.

To understand the cause of disappearance of the N=20 magic number, an investigation of the arrangement of nuclear orbitals in neutron-rich Mg isotopes was recently undertaken. Our understanding so far, guided by new shell model theories was that the N=20 gap vanishes because of the upward shift of the $1d_{3/2}$ level coming close to or crossing the $1f_{7/2}$ level. The ^{32}Mg nucleus was one of the early candidates where N=20 breakdown was observed. The location of the odd-neutron in the N=21 isotope (^{33}Mg) can be expected to shed light on this arrangement. Very surprisingly, our observations suggest that a higher lying orbital $2p_{3/2}$ is probably moving closer (or might be even crossing) the $1f_{7/2}$ orbital. This finding is also consistent with large Coulomb dissociation cross section observed for ^{31}Ne . For a full quantitative understanding of the level spacing the observations will stimulate further refinement of the models.

Topic 2: Nuclear halo, skin and equation of state of asymmetric nuclear matter through measurements of radii and density distribution of rare isotopes

Nuclei in regions away from the line of stability show unusual distribution of the excess neutrons (for neutron-rich regions). As the neutron number along an isotopic chain increases a thick neutron-rich skin is likely formed. While a small neutron skin is often discussed for the stable nucleus ^{208}Pb , the neutrons in the skin layer here are fairly strongly bound. Unlike this, in neutron-rich nuclei the region of neutron skin is expected to be much thicker and with increasing thickness the neutrons become more weakly bound than the protons. In the limit of extreme weak binding where the neutrons are within less than 1 MeV below the Fermi-level, a dramatic phenomenon happens, where the outermost one or two neutrons can move to very large distances from the rest of the nucleus forming a low-density halo. The existence of such exotic forms of nuclei is established through the determination of nuclear matter radii and density distribution.

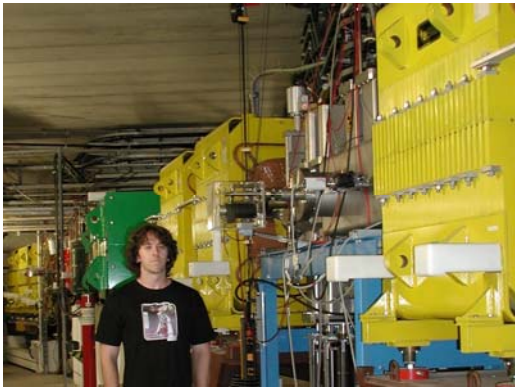

Fig 3.1.18. Saint Mary's University student Christopher Perro, working at the fragment separator, FRS, at GSI.

The highest energy beams at GSI are ideally suited to extract the matter radii through measurement of the total interaction cross section. This measurement is possible with fairly low beam intensities allowing us to access near the drip-lines. Some recent measurements around the $N=16$ and 20 regions recently performed are under analysis. A more traditional method of determining matter density is via proton elastic scattering. The inverse kinematics conditions for unstable nuclei, where the proton is the target, make these experiments quite challenging for medium heavy nuclei. The collaboration has developed a thick solid hydrogen target to facilitate such studies and the first experiment was performed recently. The elastic scattering experiments however require moderate intensities, higher than what is permissible for interaction cross section measurements.

A new attempt is underway to determine charge radii of neutron-rich isotopes from charge changing cross sections. The matter and charge radii will allow us to extract the neutron skin thickness. A systematic measurement of neutron skin places constraints on key parameters in the description of the equation of state of asymmetric nuclear matter.

3.1.3.3 Nuclear structure studies with GAMMASPHERE at ANL

The ATLAS facility at Argonne National Laboratory (ANL) can provide intense beams of stable nuclei across the periodic chart, and select radioactive beams. The prime nuclear structure facility at ANL is the GAMMASPHERE array, and it currently represents the most powerful γ -ray spectrometer at a stable beam facility worldwide. Coupled with its vast array of auxiliary detectors, and a recoil spectrometer, a wide and varied programme of nuclear structure studies can be performed. A very select program of such studies is outlined below.

Topic 1: Coulomb Excitation of the Cd Isotopes

Multi-step Coulomb excitation will be used to provide a vigorous test of the suggestion that the Cd isotopes are not spherical vibrational systems but rather possess a weakly-deformed rotational structure. Using Cd beams on a ^{208}Pb target, the scattered and recoiling ions will be detected with the CHICO heavy ion counter located in the GAMMASPHERE target chamber. The use of CHICO allows for a precise Doppler correction to be applied, and to study the γ -ray yield as a function of the scattering angle. Using the large amount of complementary data known for the Cd isotopes, especially ^{112}Cd , a GOSIA analysis will be used to extract unknown transition matrix elements and quadrupole moments. It has been demonstrated that multi-step coulomb excitation can reach very high spins (20^+ in ^{152}Sm), enabling the B(E2) values to be extracted for the proposed band structures and providing a sensitive test of the nuclear shape in a model independent way via the Kumar-Cline invariants.

In addition to the study of stable Cd isotopes, with the commissioning of CARIBU at ANL access to neutron-rich radioactive beams will become available, including the heavy Cd isotopes. The nucleus ^{118}Cd is especially important as it was claimed to be a nearly-perfect example of an harmonic vibrational system. The predicted yields of the Cd isotopes indicate sufficient beam intensity for such studies up to ^{122}Cd , and possibly ^{124}Cd .

Topic 2: β -decay studies of the Pd and Ru isotopes

One of the limitations of ISOL facilities, such as TRIUMF, is the chemical dependence of the efficiency with which specific elements can be extracted from the target/ion source. Many of the refractory elements, for example, cannot be produced (or produced with rather limited intensities in molecular forms). The beam extraction method for CARIBU, however, uses a gas stopper and thus will be highly independent of the chemistry. Using CARIBU, and the planned beam transport to the GAMMASPHERE array, the β -decay of the neutron-rich Rh and Tc isotopes will be studied. With the sensitivity of GAMMASPHERE, high-statistics studies can be performed down to beam intensities of $10^3 - 10^4$ ions/s. These studies complement the systematic studies of the Cd, Sn, Te, and Xe isotopes discussed for the 8π /GRIFFIN spectrometers, and allow the systematic study of the development of collectivity in the $Z=50$ region.

3.1.3.4 Direct reaction studies with the Q3D spectrometer at Munich

There have been recent advances in calculations for the isospin-symmetry-breaking corrections for the $0^+ \rightarrow 0^+$ Fermi superallowed β -decay programme that have resulted in significant shifts in some of the corrected Ft values. The new calculations have included the promotion of specific orbitals from (previously considered) closed-shell cores. To determine which core orbitals should be included, the results of single-nucleon transfer reactions have been examined. For some cases, this information is readily available, while for other cases it is not. The information required can be obtained from single-neutron pickup reactions, and a programme of (d,t) reactions will be performed on the targets ^{46}Ti , ^{54}Fe , and ^{64}Zn . These experiments will be performed using the powerful Q3D spectrometer (Fig. 3.1.19 below) at the Maier-Leibnitz Laboratory of the Ludwig Maximilians University and Technical University Munich (LMU/TUM). The (d,t) reactions provide not only information on which core orbitals may be important to include in the calculation, but at the same time act as important direct tests of the shell model calculations. The ^{64}Zn reaction, while not the reaction desired since it gives information on ^{63}Zn , will still provide a stringent test of the shell model calculations employed for ^{62}Ga decay.

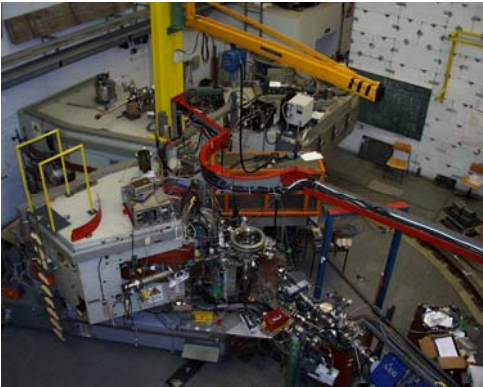

Fig 3.1.19. The Q3D spectrograph at the MLL Munich. This facility is unsurpassed world-wide for its sensitivity and resolution for light-ion induced direct reactions such as inelastic scattering and nucleon transfer.

A limitation on the amount of information that can be extracted from analysis of the superallowed decay spectrum is the knowledge of excited states in the daughter nucleus, especially for the non-analogue 0^+ states. An ideal way to obtain this information is via two-neutron-transfer reactions. The excited 0^+ states in ^{46}Ti , ^{50}Cr , and ^{62}Zn will be sought with the (p,t) reaction, also using the Q3D spectrometer at the MLL. Once located, the corresponding $0^+ \rightarrow 2^+$ transitions will be sought in the decay γ -ray spectrum.

3.1.3.5 Reaction dynamics program at GANIL

A Canadian contribution to the reaction dynamics program at GANIL has begun through the involvement in the INDRA collaboration, which was French in the early nineties but which became more international with time and which currently includes members from different countries. The nuclear reaction group at Laval University has been a full member of that collaboration for many years. The collaboration provides an opportunity to do original and unique physics studies. The Laval group has access to all data

accumulated through all INDRA measurement campaigns done at GANIL and at GSI. The last campaign was done with the INDRA multidetector system coupled to the VAMOS spectrometer to make a unique detection device. The Laval group participates in the INDRA program at all levels: it submits proposals, leads and conducts experiments, analyzes and publishes the data. This participation involves a significant number of students at both, the M.Sc. and Ph.D. level. A unique aspect of this program results from the fact that at the Ph.D. level, several students make their thesis in “cotutelle” according to an agreement between French universities and Laval. This arrangement allows students to share their research and course requirements at both universities under the supervision of two scientists, one in France and one at Laval. As a result, students can get both Ph.D. degrees with one thesis and one thesis defense held in France or at Laval, at the choice of the student.

Two students are in cotutelle presently. So far, there has been one with IPN (Lyon), one with Paris XI, two with GANIL/Caen University completed. When it is in the frame of a cotutelle, students have access to different fellowships, releasing the strain on the Laval's group budget, which in turn opens an opportunity for increased recruitment. Though this program students enjoy the opportunity to work with many collaborators from different countries. They can also frequently get help for financing their stay at GANIL (room, meals at student price, etc.).

3.1.4 International collaboration in Nuclear Theory:

Nuclear theory by its virtue is truly a collaborative effort. Numerous examples can be provided, from direct researcher-to-researcher connections to involvement in big formalized collaborations. One of the latter is the UNEDF SCIDAC collaboration whose goal is to arrive at a comprehensive and unified description of nuclei and their reactions, grounded in the fundamental interactions between the constituent nucleons. The collaboration develops connections between the ab initio approaches for light nuclei, energy-density functional theories and nuclear reactions on medium and heavy nuclei and includes TRIUMF researchers working in the field of nuclear structure.

3.1.5 International involvement at ISAC

Another aspect of the international involvement of the ISAC and Canadian nuclear structure community in the world-wide effort should not be overlooked; this is the presence of foreign researchers and students driving science programs at TRIUMF. Especially the TIGRESS facility has both enabled and been enabled by contributions to the ISAC program from the United States and United Kingdom through auxiliary detectors, in particular the Bambino and SHARC silicon detector devices. In both cases, loose, collaborations between foreign institutions and Canadian scientists were formed around a small number of well-focused experiments, where the experimental technique required both high efficiency and granularity (i.e. large numbers of small solid-angle detector elements) for both gamma-ray and charged particle products of reactions

involving accelerated rare isotopes. Bambino represents a ~\$350k (Cdn) investment by Lawrence Livermore National Laboratory and the University of Rochester, and was motivated specifically by Highlight 2.2, ^{29}Na ; it has also been used for one U.K.- and three Canadian-led experiments (e.g. Highlight 1.3, ^{12}Be), primarily investigating the shell model behavior of exotic isotopes. Although this device was well suited to those experiments, a program proposed primarily by U.K. scientists required a new device, SHARC, which was optimized for experiments especially motivated by astrophysically-motivated nuclear structure measurements. This device represented a ~\$1M CAD capital investment by U.K. and U.S. universities (led by University of York, with contributions from Colorado School of Mines, Louisiana State, Manchester and Surrey). It is worth noting that these collaborations evolved naturally from the unique expertise and talents of the scientists involved, in particular the exotic isotope expertise of TRIUMF-ISAC-II, in-beam gamma-ray spectroscopy expertise of TIGRESS, and silicon detectors for light and heavy ions of UK and US collaborators.

3.1.6 Long term vision

3.1.6.1 The next 5 years

The highest priority for nuclear physics in Canada in the next ten years is full exploitation of the high-intensity radioactive beams for structure and reaction studies at ISAC-I and ISAC-II. This implies the operation of the ISAC facility within its full capability of beam delivery for experiments with radioactive beams at TRIUMF to take full advantage of the investments made in the ISAC science program. This will be achieved through

1. Continued target and ion source development to increase the reliability, intensity and diversity of radioactive beams available to experiments at ISAC,
2. Delivery of re-accelerated beam with mass higher than 30,
3. Implementation of the actinide production target.
4. Completion of the major infrastructure improvements initiated in the current LRP cycle such as the recoil spectrometer EMMA and its focal plane detectors, the GRIFFIN spectrometer for decay spectroscopy at ISAC-I, the TIGRESS auxiliary detectors TIP and SPICE as well as the solid hydrogen target facility IRIS.

The community will also pursue a broad program of complementary efforts that will provide breadth and diversity to nuclear structure and fundamental symmetry research. In particular programs based on reactions with stable beams at ISAC and spontaneous fission with TIGRESS will be initiated. The community will also maintain the support for high-visibility science programs driven by Canadians in laboratories other than TRIUMF such as the CPT and GAMMASPHERE with CARIBU at ANL, the light-ion reactions program at GSI, direct-reaction measurements with the Q3D at Munich, and the reaction dynamics program at SPIRAL.

3.1.6.2 Beyond the next 5 years

In the 10-year time scale it is critical for the Canadian nuclear structure community to sustain its leadership in the environment when a number of next-generation radioactive beam facilities become operational world-wide. For that reason it is important to build on the expertise of TRIUMF in operating the highest power ISOL facility worldwide. To maintain this leadership for the ISAC facility it requires that the second high-intensity proton beam-line to actinide targets is secured in addition to the electron-linac and new target stations/frontends associated with the ARIEL project. The sustained leadership role of the ISAC facility will require high-intensity proton induced spallation of actinide targets since the current target stations at ISAC-I are intensity-limited. These implementations would put ISAC on the trajectory to become the first multi-user radioactive beam facility world wide with unprecedented potential for scientific discovery and advancement in the field.

3.1.7 The current scope of NP Theory efforts in support of this work

Given the complexity of many of the reaction networks that operate in stellar burning and explosive nucleosynthesis, and the locations of the various nucleosynthetic paths, which often occur very far from stability, it cannot be expected that all necessary data will be measured. Therefore, nuclear models must, at least partly, be relied upon. The development of accurate and predictive nuclear models, however, has proven to be a challenge for decades. The very nature of the strongly interacting many-body system does not lend itself to easy computation. Nuclear structure experiments reveal the properties of nuclei in an attempt to understand their natures and to guide the development of nuclear models so that they are able to accurately predict properties beyond the reach of experiment.

From nuclear forces to nuclei: From the theoretical point of view enormous progress has been made in the last decade in understanding atomic nuclei as quantum many-body objects made by protons and neutrons interacting together with effective forces that originate from the fundamental theory of quantum chromo-dynamics. Recent advances in the framework of chiral effective field theory have allowed the systematic derivation of nuclear interactions in terms of effective degrees of freedom, starting from the symmetries of quantum chromo-dynamics. The predictive power of this theory has to be tested on a variety of nuclear observables by comparing accurate calculations with experimental observations. The theoretical challenge lies in describing the nuclear dynamics starting from the first principles of quantum mechanics. Only with such a microscopic approach can one hope to achieve a unified view and a deeper understanding of nuclear properties.

The TRIUMF theory group aims at combining the recent major advances in developing nuclear forces and ab-initio many-body methods to study a variety of phenomena, including halo nuclei, neutron-rich isotopes of medium-light elements and electroweak reactions on light nuclei. The many-body theoretical methods in use include coupled cluster theory, hyper-spherical harmonics expansions and the Lorentz Integral Transform

method. This project exploits synergies with the rare isotope physics program at TRIUMF as well as with other nuclear laboratories abroad. An example of such theoretical studies is provided by Fig. 3.1.20.

Ab-initio theory of light nuclear reactions: Reactions important for astrophysics, such as ${}^7\text{Be}(p,\gamma){}^8\text{B}$, ${}^3\text{He}(\alpha,\gamma){}^7\text{Be}$ or the famous ${}^{12}\text{C}(\alpha,\gamma){}^{16}\text{O}$ are hard or impossible to measure at energies at which they occur in the stellar environment. The measurements are typically performed at higher energies and then extrapolated to the energy of interest. A predictive, reliable nuclear theory of these reactions is then essential. Even if low energy measurements are achievable in underground laboratories, the beam-target experiments suffer from electron screening absent in the stellar environment. Again, predictive nuclear theory becomes indispensable to extract the correct physics. The No-Core Shell Model/Resonating Group Method (NCSM/RGM) calculations underway at TRIUMF are currently the best efforts in this direction. An example of recent (and the first ever *ab-initio*) calculation of the ${}^3\text{He}(d,p){}^4\text{He}$ reaction is presented in Fig. 3.1.20. Similarly, predictive *ab-initio* nuclear theory is essential to understand fusion reactions important for future energy generation such as the ${}^3\text{H}(d,n){}^4\text{He}$ as well as the accompanying processes involving tritons such as $n+{}^3\text{H}$ scattering or ${}^3\text{H}({}^3\text{H},2n){}^4\text{He}$ that are hard to measure in particular when no triton beams are available. These reactions can be calculated within the NCSM/RGM approach. Presently, a member of the TRIUMF theory group is investigating the ${}^7\text{Be}(p,\gamma){}^8\text{B}$ S-factor within the NCSM/RGM. Also, the experiments with exotic nuclei at rare isotope facilities will benefit from calculations performed within our first-principles nuclear structure and reaction calculations.

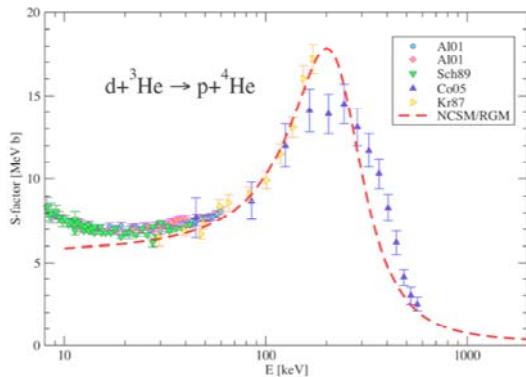

Fig. 3.1.20. Experimental results for the S-factor of the ${}^3\text{He}(d,p){}^4\text{He}$ reaction. The dashed line represents the *ab-initio* NCSM/RGM calculation. No low-energy enhancement is present in the theoretical results contrary to the laboratory data.

Coupled-channel theory for light ion reactions: Using a recently developed methodology for Multi-Channel Algebraic Scattering (MCAS), a method of coupled channels is also used to obtain detailed information about the scattering of nucleons, or light ions of mass 3 and mass 4, on light and medium-mass nuclei. These studies provide information on the interactions between light and medium mass nuclei, corresponding reaction rates, as well as the structure of the compound nuclei formed as bound states of the projectile with the target nucleus. With the advent of radioactive ion beam experimental facilities, such as ISAC-I and ISAC-II at TRIUMF, the range of nuclei that is subject to detailed experimental study has increased enormously. The comparison between predictions and data is no longer confined to the narrow valley of stability but can be explored towards the proton and neutron drip lines. The predictive power of the

MCAS formalism is demonstrated best by the calculations for the proton-unstable ground state and several narrow, high-energy resonances published for ^{15}F three years prior to experimental observations. The method having been tested for well-known stable systems, is now being applied to unstable systems, nuclei at and beyond the drip lines, such as all the mass-7 isobars, ^{15}F already mentioned, as well as exotic processes such as hyperon scattering. These studies are able to provide reliable information on radiative capture (fusion) processes at very low energies for nuclear systems important to stellar evolution and nucleosynthesis.

Progress and developments of the collective model: Major goals of some nuclear structure researchers are to establish the shell model in its most general form as the standard model of nuclear physics and to express the various collective models as sub-models of the shell model. Enormous advances have been made in recent years in establishing the shell model as a many-nucleon theory of nuclei with interactions derived from few-nucleon data and effective field theory. However, for medium and heavy mass systems it must be recognized that the shell model in its most general form is really a formal framework and that practical calculations can only be carried out in highly truncated model spaces. Thus, instead of attempting to describe nuclear data with a shell-model calculation in the largest space that can be handled with the best effective interactions available, it appears to be profitable to start from preliminary interpretations of the data in terms of phenomenological models and subsequently to use these models to identify appropriate shell-model coupling schemes and truncated spaces to gain a microscopic many-nucleon understanding of what is observed. An algebraic paradigm for proceeding in this way drives recent developments of the collective model as a tool for understanding the structure of medium and heavy-mass nuclei.

In particular, it has been shown that by expressing phenomenological models of nuclear phenomena in algebraic terms, and then using Lie algebra representation theory to map the states of these models into microscopic shell model states, it is possible to give the phenomenological models a microscopic interpretation and subsequently seek an explanation of why their symmetries are preserved by realistic and fundamental nucleon interactions.

A research program in current progress is the application to nuclear theory of some powerful methods of invariant theory developed in mathematics. Investigations of the significance of these methods in nuclear physics reveal a remarkable duality relationship between symmetry groups and quite distinct dynamical groups. Thus, whereas symmetries have traditionally contributed enormously to the solution of model problems, their relationship with commuting dynamical groups prove to extend the power of group theory in understanding nuclear structure to a remarkable extent. A lengthy review article on the applications and potential applications of these dual symmetries is currently being prepared for publication in the *Reviews of Modern Physics*.

Recent progress has seen the publication of a book, entitled "Fundamentals of Nuclear Models" by David Rowe (University of Toronto) and John L. Woods (Georgia Institute

of Technology), which reviews both the experimental and the mathematical foundations of the current models of nuclear structure. A second volume is in preparation.

3.2 Nuclear Astrophysics

3.2.1 Introduction

The key question in nuclear physics of how protons and neutrons are bound together into nuclei is closely connected to the question of how the chemical elements were formed in stars and the early universe. Ultimately, we seek a theoretical understanding of the quantum many-body problem of the atomic nucleus that will enable us to reliably predict the properties of all nuclei and make sense of the observed abundances of the elements. To solve this fundamental problem, it is essential to study nuclei far from stability because our present understanding of nuclear structure is based almost entirely on the properties of stable nuclei. Moreover, many of the nuclei involved in stellar and explosive nucleosynthesis and in astrophysical energy production are unstable; therefore the reactions they undergo are very difficult to initiate in the lab and the overwhelming majority have not yet been studied. It is neither possible nor necessary to study every single nucleus and reaction, since important cases can be identified and used to test nuclear theory and constrain the necessary extrapolations into unknown territory. Further progress in nuclear astrophysics is directly tied to precise new experiments with both stable and radioactive beams.

One of the principal goals of nuclear astrophysics is to determine how and where the chemical elements were formed. Both by mass and by sheer numbers, the lightest two elements H and He represent the overwhelming majority of nuclei. This can be seen in Fig. 3.2.1, which plots the observed abundances of the isobars in the solar system. Our understanding of the origin of H and He is relatively complete, with primordial big bang nucleosynthesis and the hydrostatic stellar fusion of H into He accounting for their enormous universal abundances. Apart from the light nuclei with mass number A satisfying $4 < A < 12$, which were produced dominantly by cosmic ray spallation reactions, nuclei with $12 \leq A < 70$ were produced in both hydrostatic stellar fusion and in supernova explosions. Charged particle induced reactions on nuclei with $A > 56$ are generally endothermic and therefore most heavy nuclei are produced by other means, principally neutron capture.

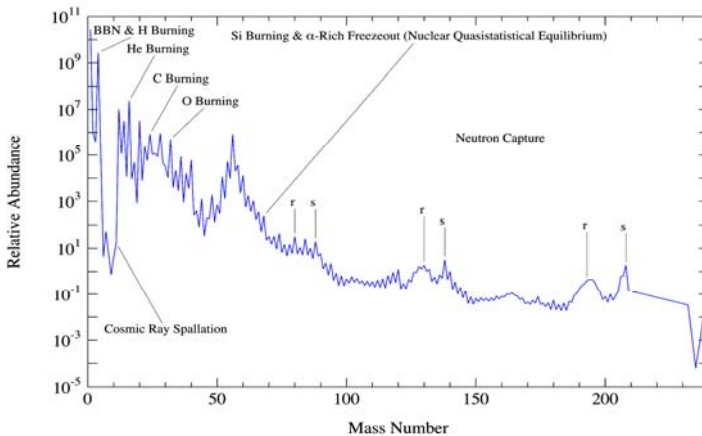

Fig. 3.2.1. Relative abundances of the isobars in the solar system

3.2.2 Ongoing Work and Future Plans

Most stars are powered by the fusion of H into He either directly via the pp chains or using heavier elements as catalysts in the CNO cycles. Following the exhaustion of H fuel, the cores of these stars contract and heat up, allowing He burning to begin through the 3α and subsequent $^{12}\text{C}(\alpha,\gamma)^{16}\text{O}$ reactions. As the temperatures that characterize this quiescent stellar burning are very low by nuclear physics standards, the rates of H- and He-induced thermonuclear reactions must be known at very low energies, generally below the reach of direct experimental measurements. For this reason, indirect laboratory measurements and reliable nuclear reaction theory are indispensable for extrapolating direct measurements to determine the rates of thermonuclear reactions in most stars, including the Sun. Recent efforts in *ab initio* nuclear theory combining the no-core shell model with the resonating group method promise to greatly improve the reliability of cross section extrapolations from accessible energies to those relevant to the stars. The focus of current and planned theoretical work at TRIUMF is on the $^7\text{Be}(p,\gamma)^8\text{B}$, $^3\text{He}(\alpha,\gamma)^7\text{Be}$, and $^{12}\text{C}(\alpha,\gamma)^{16}\text{O}$ reaction rates. The first two are vital for predictions of solar neutrino fluxes while the last has a prodigious effect on all stellar evolution and nucleosynthesis occurring after He burning, including core collapse supernova explosions.

With experiments at TRIUMF's ISAC facility, the Canadian community is already making important contributions at the forefront of understanding hydrostatic stellar nucleosynthesis. Fig. 3.2.2 shows a γ ray spectrum from a recent $^{12}\text{C}(\alpha,\gamma)^{16}\text{O}$ measurement using ISAC's DRAGON recoil mass spectrometer which identified an important transition that had been neglected previously. Energy release in the CNO cycles is controlled by the slowest reaction in the sequence, $^{14}\text{N}(p,\gamma)^{15}\text{O}$. Direct measurements of this reaction rate at stellar energies are impossible, but the largest remaining uncertainty is due to the lifetime of a state in ^{15}O that is the subject of measurements at ISAC's DSL facility. A measurement of the $^3\text{He}(\alpha,\gamma)^7\text{Be}$ reaction rate, relevant to both solar neutrino production and big bang nucleosynthesis, is planned at DRAGON. In addition, a measurement of $^7\text{Be}(p,p)^7\text{Be}$ is planned with the active target TACTIC to help constrain extrapolations of $^7\text{Be}(p,\gamma)^8\text{B}$.

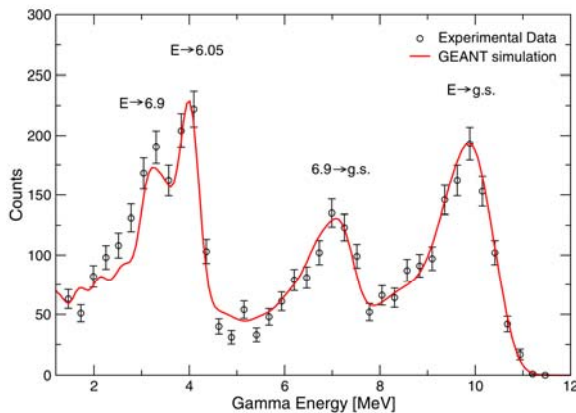

Fig. 3.2.2. γ ray spectrum obtained in coincidence with ^{16}O recoils in TRIUMF's $^{12}\text{C}(\alpha,\gamma)^{16}\text{O}$ measurement

3.2.3 Catastrophic Binaries: Novae and X-ray Bursts

A large fraction of stars are found in binary systems. As the two stars don't generally evolve at the same rate, many of these systems contain an ordinary star and a stellar remnant, either a white dwarf or a neutron star. If the separation between the star and remnant is small enough, matter can be transferred from the star to the remnant via an accretion disk, eventually falling onto the surface of the remnant. When the temperature and density at the base of the accreted layer grow large enough, explosive thermonuclear fusion reactions begin and rapidly consume the accreted fuel. If the accreting stellar remnant is a white dwarf this is known as a classical nova while if the remnant is a neutron star, the resulting explosion is a Type I x-ray burst.

3.2.4 Future Plans

Choosing which of the thousands of nuclear reactions that may occur in these events to study experimentally is motivated by their expected influence on the energy release in the explosion and on the resulting nucleosynthesis. Of particular interest are the reactions that strongly influence the production and destruction of radionuclides whose decays lead to the emission of potentially detectable γ rays, such as ^{18}F , ^{22}Na , and ^{26}Al . The identification of these important reactions in all stellar environments through sensitivity studies is the major aim of the planned Canadian Nuclear Astrophysics Centre to be located at TRIUMF. This interdisciplinary Centre would bring together the experimental expertise at McMaster and TRIUMF with the observational astronomy capabilities at Alberta, Manitoba, McGill, and UBC and the theoretical modeling expertise at McGill, UBC, and Victoria. The Centre would include a server for running the state-of-the-art NuGrid and MESA stellar evolution and nucleosynthesis codes and two postdocs who can maintain this system, modify the codes for user-specific applications, and assist users in running their own simulations. It would also support two graduate students as well as an undergraduate co-op student. Such a Centre would enhance and guide the experimental nuclear astrophysics program at TRIUMF, provide training opportunities for postdocs, graduate and undergraduate students at participating universities, and provide the participating groups with enhanced international visibility and an organizational framework for international collaboration and workshops.

3.2.5 Past Accomplishments

TRIUMF is already recognized worldwide for its direct measurements of nuclear reactions important in these cataclysmic binary systems. Highlights from DRAGON include the textbook example of measuring a radiative capture reaction with a radioactive beam, $^{21}\text{Na}(p,\gamma)^{22}\text{Mg}$, and the determination of the weakest resonance strength ever measured in inverse kinematics with a radioactive beam, $^{26g}\text{Al}(p,\gamma)^{27}\text{Si}$. The particle identification spectrum from the latter measurement is shown in Fig. 3.2.3. Indeed, of the six radiative capture measurements ever made with radioactive beams, three were performed at TRIUMF using DRAGON. All of these reactions are related to the production or destruction of γ ray emitters in classical novae. In the near future, $^{18}\text{F}(p,\gamma)^{19}\text{Ne}$ and $^{26m}\text{Al}(p,\gamma)^{27}\text{Si}$ will be investigated with DRAGON to determine their effects on ^{18}F and ^{26}Al yields in classical novae.

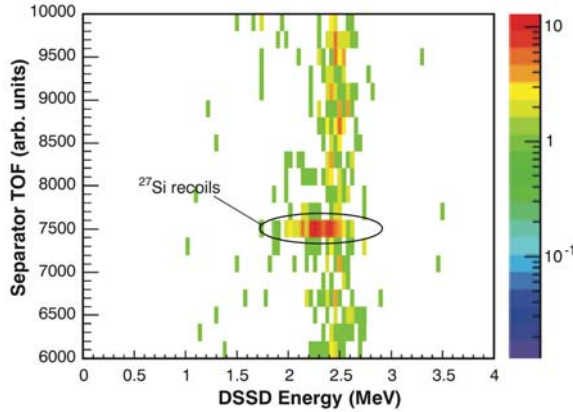

Fig. 3.2.3. Recoil nucleus particle identification spectrum from TRIUMF's $^{26}\text{gAl}(p,\gamma)^{27}\text{Si}$ measurement

Astrophysically important reactions that have only charged particles and no photons in the final state are studied directly at ISAC using the TRIUMF United Kingdom Detector Array (TUDA) facility. Recently the only direct measurement of the $^{18}\text{F}(p,\alpha)^{15}\text{O}$ reaction rate at energies relevant to classical novae was carried out at TUDA. Further measurements of this reaction rate may be required to eliminate remaining uncertainties. Indirect measurements to study the properties of nuclei relevant to nova nucleosynthesis such as $^{30,31}\text{S}$ via transfer and fusion-evaporation reactions are planned with the combination of EMMA and TIGRESS and at stable beam facilities with high resolution magnetic spectrometers such as Yale and Munich.

In Type I x-ray bursts lacking appreciable amounts of H fuel the thermonuclear runaway is initiated by the 3α reaction. If the accreted fuel is rich in H the hot CNO cycles operate until the temperature rises enough to initiate breakout from the CNO cycles into the rp process via the $^{15}\text{O}(\alpha,\gamma)^{19}\text{Ne}$ reaction and subsequently the $^{18}\text{Ne}(\alpha,p)^{21}\text{Na}$ reaction. These breakout reactions have a strong impact on the predicted x ray light curves and the former reaction may be crucial in igniting the burst. While direct measurements of the $^{15}\text{O}(\alpha,\gamma)^{19}\text{Ne}$ reaction rate are presently impossible, precise measurements of the lifetimes and α decay branching ratios of the relevant states in ^{19}Ne can be used to determine the rate to sufficient precision. Recently the lifetime of the dominant state at x-ray burst ignition temperatures was measured at TRIUMF's DSL facility. The Doppler shifted γ ray spectra and best fitting lineshapes are shown in Fig. 3.2.4.

The study of reactions that create and destroy cosmic γ ray emitting radionuclides is not limited to those that occur in binary systems. Most of the ^{26}Al found in the galaxy is thought to be formed in massive stars and supernovae. At Los Alamos National Lab, the Canadian community is planning measurements of the two reactions whose uncertainties significantly limit the precision of predictions of ^{26}Al yields in these environments, $^{26}\text{Al}(n,\alpha)^{23}\text{Na}$ and $^{26}\text{Al}(n,p)^{26}\text{Mg}$ using the new NEURAL detector. In addition, the destruction of the detected γ ray progenitor ^{44}Ti via the $^{44}\text{Ti}(\alpha,p)^{47}\text{V}$ and $^{44}\text{Ti}(\alpha,\gamma)^{48}\text{Cr}$ reactions in supernovae will be studied with TUDA and DRAGON respectively.

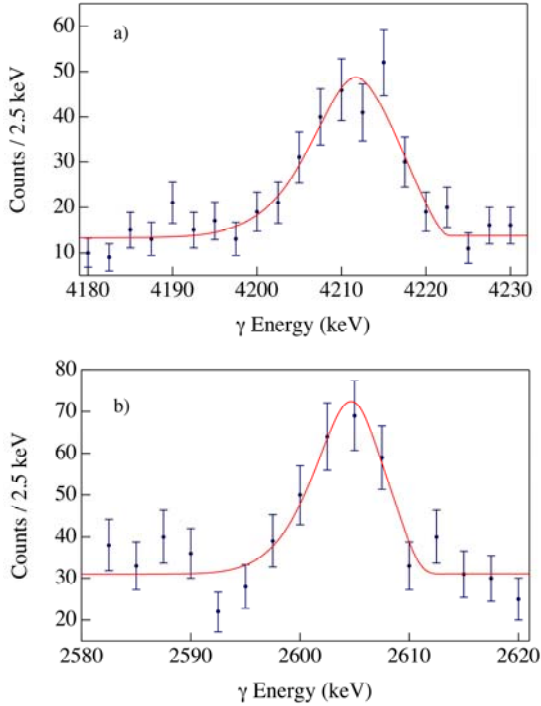

Fig. 3.2.4. Doppler shifted γ ray spectra of the transition from the 4.03 MeV level in ^{19}Ne to (a) the ground state, and (b) the excited state at 1.54 MeV.

3.2.6 Future Plans

In the near future the $^{18}\text{Ne}(\alpha, p)^{21}\text{Na}$ reaction rate will be measured directly using TUDA. Other indirect measurements addressing reactions of interest in Type I x-ray bursts are planned with TUDA, including $^{37}\text{K}(p, \alpha)^{34}\text{Ar}$, $^{18}\text{Ne}(^6\text{Li}, d)^{22}\text{Mg}$, and $^{21}\text{Na}(p, \alpha)^{18}\text{Ne}$; inelastic proton scattering will be used for the same purpose with TIGRESS and SHARC.

3.2.7 Future Initiative: Neutron Rich Nuclei with ARIEL

The question of the origin of the heavy elements is universally acknowledged to be one of the most important unsolved problems in science. The present evidence indicates that roughly half of the elements heavier than zinc ($A \sim 70$) are synthesized in a series of rapid neutron capture reactions interspersed with photodisintegrations and β decays known as the r process. This production mechanism involves highly unstable, neutron-rich nuclei that can't be found on Earth.

At least two distinct neutron capture processes are thought to be responsible for the production of nearly all the heavy elements ($A > 70$), the slow (s) and rapid (r) neutron capture processes. The adjectives slow and rapid describe the average pace of neutron captures in the processes relative to the β^- decay lifetimes typical of the nuclei involved. The s process hews close to the valley of β stability and involves neutron captures that are slower than the β^- decay rates of the nuclei that participate. Hence the nuclei involved are stable or have relatively long β decay lifetimes and can be fashioned into targets and bombarded with neutrons to experimentally determine their capture rates and expected abundances. In contrast, the r process is a series of rapid neutron captures that takes place in a hot environment with an extraordinarily high density of free neutrons ($> 10^{20} \text{ cm}^{-3}$),

combined with a series of β^- decays that bring the newly formed, neutron-rich nuclei closer to the valley of β stability. The s process has at least two distinct components, one responsible for producing light and another for heavy elements. Similarly, abundance differences between light and heavy r process nuclei found in primitive meteorites led to the idea that there are at least two distinct r process components or sites. However, all the detailed astrophysical models constructed to date fail to produce conditions that lead to a robust r process that can successfully account for the elemental abundances observed in old stars and the solar system. Given the uncertainty in the astrophysical site, experimental and observational constraints are crucial. Dynamical calculations of the core-collapse supernova scenario suggest that a wide range of correlated parameters such as neutron density and entropy can result in r process nucleosynthesis, so it is presently impossible to uniquely specify the astrophysical conditions that obtain during the process.

For this reason r process calculations are typically performed in a astrophysical site-independent waiting point approximation. This assumes that the temperature and neutron density are so high that for a given element, neutron captures proceed rapidly until reaching an isotope whose neutron separation energy is so low that its neutron capture rate is in equilibrium with the photodisintegration rate of its neutron capture daughter. This $(n,\gamma) - (\gamma,n)$ equilibrium implies that the neutron captures within an isotopic chain halt at waiting point nuclei which must β^- decay before further neutron captures can occur, synthesizing heavier nuclei. Once the free neutrons are exhausted or the temperature drops sufficiently, the neutron capture reactions fall out of equilibrium with the corresponding photodisintegrations (freezeout), and the remaining nuclei β^- decay back toward stability. These waiting point nuclei are said to lie in the r process path or be r process progenitors since at the time of the freezeout, the vast majority of the isotopes of a given element are the waiting point nuclei.

In addition to β decay lifetimes, the identities of the waiting point nuclei depend principally on their neutron separation energies S_n , and the temperature and neutron density of the environment, which determine the abundances in an $(n,\gamma) - (\gamma,n)$ equilibrium. Since the astrophysical site of the r process remains unknown, the temperature is uncertain. Moreover, within any given scenario the temperature drops with time, implying that a range of different S_n values define the r process path. In the core collapse supernova scenario, the path is defined by $2 \text{ MeV} < S_n < 4 \text{ MeV}$. Since S_n is given by the mass difference between adjacent isotopes, nuclear masses determine the location of the r process path and thereby have the largest influence on predicted r process abundances.

Even if the neutron separation energy of the r process path nuclei were known precisely, the waiting points would be extremely neutron-rich nuclei about which very little is known, including masses. For this reason, calculations rely on global nuclear mass models whose parameters have been adjusted to reproduce the masses of nuclei that have been measured with a root mean square deviation around 700 keV. It is clear from comparisons of these different mass models that there is a degeneracy between the astrophysical conditions and the nuclear masses, i.e., the same final abundances can be produced by different combinations of physical conditions and the hypothesized masses

of unmeasured neutron-rich nuclei. The behaviour of the mass trends near the closed neutron shells, e.g. $N = 82$, has the most profound influence on the final abundances. Systematic studies of the masses and low-lying excited states of neutron-rich nuclei must be performed to look for deviations from theoretical predictions. Even where the (hypothesized) r process path cannot quite be reached, it would still be very helpful to precisely measure the masses of neutron-rich nuclei as far out along an isotopic chain as possible, seeking surprises. It will likely never be possible to measure the masses of all the relevant nuclei. Therefore, the nuclear mass models that must be relied upon to extrapolate to neutron-rich nuclei beyond the reach of present experiments will continue to be crucial; they must be tested and refined using data near the closed neutron shells, particularly $N = 82$.

To date, the masses of only about a dozen r process progenitors have been measured, most only via rather imprecise β^- decay Q value determinations. With neutron-rich beams produced by the photofission of uranium at TRIUMF's new ARIEL facility and the spontaneous fission of ^{252}Cf at Argonne National Lab's CARIBU facility, the Canadian community will be able to make important contributions to the understanding of the r process through mass measurements. It will be possible to reach the r process path in a number of places, but substantial coverage of the path near $N = 82$ represents the most exciting opportunity. The best option will be direct mass measurements using TITAN and the Canadian Penning Trap (CPT). Yield calculations indicate that we will be able to reach some of the most important r process waiting point nuclei whose masses have not yet been measured or confirmed, including $^{126,127,128}\text{Pd}$, ^{129}Ag , $^{131,132}\text{Cd}$, $^{131,132,133}\text{In}$, $^{134,136}\text{Sn}$, $^{137,139}\text{Sb}$, and $^{138,140,142}\text{Te}$.

In addition to strongly influencing the progenitor abundances, β^- decay lifetimes determine the timescale of the r process, particularly at and near the closed neutron shells at $N = 50$ and 82 . TRIUMF will make an impact in this area by carrying out β^- decay lifetime measurements using the 8π array when it is possible to produce and ionize the nuclei of interest before they decay. In cases where the lifetime is too short for this, EMMA can be used to study the β^- decays of nuclei produced in secondary reactions.

Beta-delayed neutron emission probabilities P_n affect the final abundances in the r process by shifting the mass of a decaying nucleus by one mass unit and liberating neutrons at late times far from thermal equilibrium. This has the effect of smoothing out the odd-even staggering present in the progenitor abundances to some extent. However in the scenarios with high entropy, freezeout occurs very quickly and the capture of neutrons after the $(n,\gamma) - (\gamma,n)$ equilibrium is broken is not very significant. Moreover, measurements indicate that the P_n values of the relevant nuclei that have been studied are not very large. If these assessments hold true as more measurements are performed, then the importance of non-equilibrium neutron capture is not great. But if not, the neutrons liberated following these decays will quickly be captured again by other nuclei, again shifting the mass distribution. In this case the neutron capture rates for nuclei which lie closer to stability than those in the r process path are likely to influence the final abundances. Although direct (n,γ) measurements are not presently feasible on these radioactive nuclei, theoretical efforts to relate (d,p) and (n,γ) reaction cross sections have

met with success and may allow a determination of some relevant bound state neutron capture cross sections using the powerful combination of TIGRESS, SHARC, and EMMA.

Experimental data on the β^- decay lifetimes and P_n values of r process progenitors and daughters have been obtained for approximately 50 nuclei from ^{68}Fe to ^{140}Te . Since such experiments require lower beam intensities and can be performed with less pure beams than mass measurements, more progress has been made. Yet there are still a number of nuclei around the $N = 82$ shell closure for which lifetime and P_n values remain unmeasured. Some that will be within reach at TRIUMF include a number of nuclei in the Zr to Pd ($40 \leq Z \leq 46$) region. Among these, the most important ground state cases are ^{110}Zr and ^{128}Pd . While Zr is a highly refractory element that effectively resists ionization, its isotopes can be reached via proton transfer reactions with Y beams. Low-lying isomers that are likely to be thermally populated in any reasonable r -process scenario can have an important role in astrophysical outcomes. Examples of such nuclei with important low-lying isomers that have not been definitively measured include ^{129}Ag , ^{131}In , and ^{127}Rh . For such cases, experiments with EMMA, SHARC, DESCANT, and TIGRESS will enable substantial progress on lifetime and P_n determinations.

3.2.8 International Collaborations

The principal international collaborators on nuclear astrophysics experiments at ISAC include groups from the University of York and the University of Edinburgh in the UK, the Colorado School of Mines, Louisiana State University, and Yale University. The TRIUMF-led NEURAL Experiment at Los Alamos National Laboratory also involves collaborators from TU Munich and Argonne National Laboratory. Reciprocally, Canadians make measurements at Argonne, CNS Tokyo, TU Munich, the NSCL, and the University of Washington.

The TRIUMF group collaborates with a modeler at the IEEC in Barcelona investigating the impacts of nuclear reaction rate measurements on models of classical novae and x-ray bursts. Recently the TRIUMF group has begun collaborating with a modeler at the NSCL on sensitivity studies of nuclear reaction rates in x-ray bursts and on extrapolating pp chain reaction rate measurements to solar energies for neutrino flux predictions.

3.2.9 Future Needs

The most important factors that will enable the success of the Canadian community in nuclear astrophysics are the following.

1. Continued support for Canada's first class experimental facilities such as DRAGON, TUDA, TACTIC, NEURAL, EMMA, TITAN, and the CPT to permit their full exploitation
2. Rapid development and reliable delivery of new radioactive beams at TRIUMF-ISAC
3. Support for the new Canadian Nuclear Astrophysics Centre

4. Hiring of additional nuclear astrophysics faculty at Canadian universities
5. Hiring of theorists active in nuclear astrophysics at TRIUMF and Perimeter
6. A new LaBr_3 array for γ ray detection at DRAGON and TACTIC

3.2.10 Facilities

3.2.10.1 DRAGON

The DRAGON spectrometer at ISAC, depicted in Fig. 3.2.5, was designed to measure the rates of (p,γ) and (α,γ) reactions important for energy release and nucleosynthesis in novae and x-ray bursts. Radioactive and stable heavy ion beams are accelerated up to astrophysical energies and bombard a windowless target filled with hydrogen or helium gas. The recoiling fusion products are emitted around 0° and enter the recoil mass separator. Using magnetic and electrostatic elements in two main stages, the recoiling fusion products are separated from the beam and detected at the focal plane. Beam suppression ranging from 10^8 to 10^{13} is routinely achieved by the electromagnetic separator, and additional suppression of up to 10^5 is obtained when the recoil is observed in coincidence with the emitted prompt reaction γ ray using a BGO array around the gas target. In addition, time of flight and energy considerations allow further background suppression in software. The collaboration currently consists of 10 NSERC eligible researchers from TRIUMF, McMaster, Simon Fraser, UNBC, and Toronto.



Fig. 3.2.5. DRAGON at TRIUMF-ISAC

3.2.11 EMMA

The ElectroMagnetic Mass Analyser EMMA is a versatile recoil mass spectrometer currently under construction for ISAC-II at TRIUMF. Its large angular acceptance (20 msr) and energy acceptance ($\pm 20\%$) facilitate high recoil detection efficiency without compromising mass resolving power. As such it will be used in a variety of nuclear structure and astrophysics measurements of fusion evaporation and transfer reactions to identify the heavy recoils and isolate them for subsequent decay studies. EMMA has been designed to operate in conjunction with TIGRESS as shown in Fig. 3.2.6; it is estimated that approximately half of all TIGRESS experiments will require EMMA for coincident recoil detection. The EMMA collaboration includes 13 NSERC-eligible researchers from Guelph, McMaster, St. Mary's, Simon Fraser, and TRIUMF. EMMA will be commissioned by 2013.

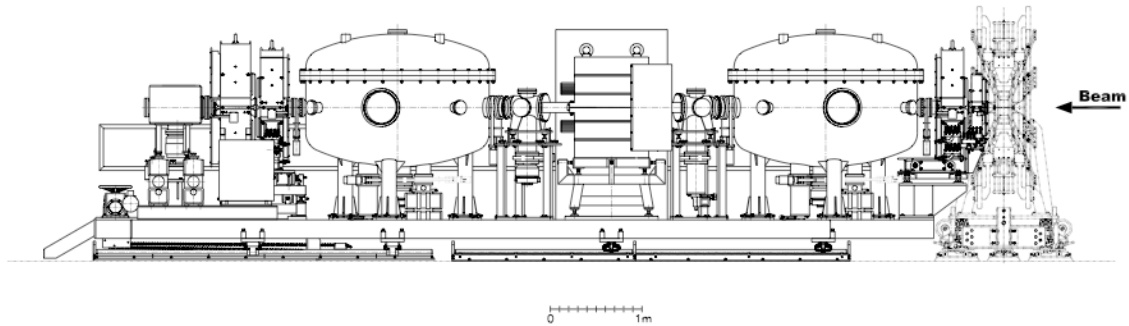

Fig. 3.2.6. EMMA with TIGRESS surrounding the target position

3.2.12 TUDA and TACTIC

The TRIUMF United Kingdom Detector Array (TUDA) is an array of highly segmented annular Si detectors designed to identify charged particles emitted from reactions of radioactive beams at astrophysical energies. This facility is complementary to DRAGON in that DRAGON is designed for radiative capture studies whereas TUDA is used for reactions with charged particles in the final state. The TUDA facility is an extremely flexible apparatus that can be modified internally to meet the needs of a variety of experiments. The Si detectors can be positioned both upstream and downstream of the target up to 75 cm away. The chamber can accommodate both foil targets and gas cells and can be moved between ISAC-I and ISAC-II as needed. The TACTIC detector, being developed by TRIUMF and the University of York, shown in Fig. 3.2.7, is a time projection chamber that employs He gas as an active target. The Canadian component of the TUDA and TACTIC collaboration consists of 7 NSERC eligible researchers from McMaster, Simon Fraser, UNBC and TRIUMF.

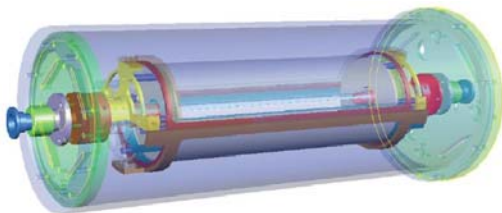

Fig. 3.2.7. TACTIC, an active target time projection chamber

3.3 Fundamental symmetries and Physics Beyond the Standard Model

3.3.1 Overview

Low energy tests of fundamental symmetries in nuclei and atoms have traditionally played an important role in the search for ‘new’ physics. The field is more active than ever, particularly in Canada, and is complimentary to the searches carried out at the ‘energy frontier’ by colliders. The study of symmetries in subatomic physics is of key importance for two reasons. On one hand, the fundamental forces and conservation laws of nature are intimately linked to corresponding symmetries; the investigation of those symmetries and their violations give unique insights. In addition, from a practical point of view, symmetries can be exploited to single out vanishingly small signatures of new physics in the presence of much larger ‘conventional’ interactions, giving low-energy experiments a physics reach to energy scales order of magnitude higher, and keeping them competitive with direct searches conducted at colliders. As an example, at the Z -resonance, the neutral current weak interaction dominates as real Z bosons are readily observed in e^+e^- collisions; in an ordinary atom with binding energies on the order of electron volts, the Z -boson exchange amplitude between electrons and quarks is 12 or more orders of magnitude suppressed relative to the prevalent electromagnetic photon exchange, yet with help of the violation of the parity symmetry in the Z -exchange, this amplitude has been measured to 0.3%, providing an important test of electroweak physics.

Our current understanding of the fundamental interactions and symmetries is reflected in the Standard Model (SM); constructed 40 years ago, it is essentially still in agreement with experimental findings. It is a quantum field theory founded on the assumptions of Lorentz symmetry and invariance under the combined transformation of charge (C), parity (P), and time reversal (T), or CPT. Since the 1950’s and 60’s we know that C, P, CP, and T are violated separately. However, the Standard Model contains an uncomfortably large number of free parameters, and while the P and CP symmetry violations have been successfully incorporated, the SM cannot explain their origin. In addition, no link exists between the SM and gravity (GR).

Theories such as quantum gravity and string theory are pursued intensely as a unifying approach valid up to the Planck scale. While they yield the SM and GR in the low-energy regime, they frequently assume Lorentz and CPT violation. High precision, low-energy fundamental symmetry-type experiments in nuclei and atoms can probe for very faint remnants of these symmetry violations occurring at energies far beyond the current frontier of direct searches.

In Canada, there is currently a strong community of researchers working on fundamental symmetry tests. The work covers many of the hot topics and also has a remarkable breadth in the experimental approaches, from electron scattering experiments at the GeV level to beta decay in laser traps using atoms at micro-Kelvin temperatures.

3.3.2 What are the pressing questions that need to be answered?

- Is there additional CP and T violation beyond what has been observed in kaons and B-mesons, and could this explain the apparent matter-antimatter asymmetry in the universe? This is an extremely important topic that also illustrates the connections between the subatomic and the cosmology frontier. Searches for permanent electric dipole moments (indicative of T-violation) in neutrons, nuclei and atoms try to answer this question, along with direct T-violating decay observables.
- What is the structure of the weak interaction? Soon after the discovery of parity violation, it was established in the early 1960's that the weak interaction current is predominantly of vector-axial vector (V-A) structure. This form was adopted in the SM. Surprisingly, the current data cannot rule out other possibilities such as scalar or tensor interactions at the few percent level. Other important questions are the unitarity of the CKM matrix and the validity of the conserved vector current hypothesis.
- Can we find violations of Lorentz and CPT invariance? Both symmetries are closely linked through the CPT theorem and the 'reverse' CPT theorem. Any observation of a violation of one of them would have profound consequences for our understanding of nature. The Standard Model is a quantum field theory founded on Lorentz and CPT invariance. Anything beyond is a glimpse at what is happening towards the Planck scale.

3.3.3 Fundamental Symmetries in Canada

Canada has a sizeable, strong, and diverse community of experimenters in the field of fundamental symmetries, supported by Canadian theorists in nuclear and particle physics. The field is represented by the working group "Beyond the Standard Model" within the Canadian Institute of Nuclear Physics (CINP); the group has currently 34 members and is the largest one within the CINP. In July 2010, one of the first CINP-sponsored events, the international workshop "Fundamental Symmetries 2010" was held at TRIUMF, bringing together 50 researchers from around the world. An impressive array of work was presented, underlining the vitality of fundamental symmetries research in Canada and world-wide. In addition to exciting results from running experiments, a large number of new, promising initiatives were presented. Clearly, within the next five and ten years, significant progress will be made in the search for new physics beyond the Standard Model, given the right level of support.

In 2010, Canadian researchers equivalent to roughly 71 FTEs (grant eligible (GE): 32, research associates and postdocs (PDF): 14, graduate students (GS): 25) were active in fundamental symmetries research. Operating grants in 2010 amounted to \$ 1,950,000 with significant additional support for equipment and facilities.

3.3.4 Highlights from the past five years

During the past five years, Canadian researchers have obtained some impressive achievements. The TWIST experiment at TRIUMF delivered order of magnitude improvements in the precision of the muon decay parameters ρ , δ , and $\mathcal{P}_\mu^\pi \xi$. At ISAC, great progress was made in measuring lifetimes and branching ratios in beta decay, in particular ^{62}Ga , $^{38\text{m}}\text{K}$, $^{26\text{m}}\text{Al}$, ^{18}Ne , ^{74}Rb , vital to testing the unitarity of the CKM matrix and the validity of the conserved vector current hypothesis. The Qweak experiment at Jefferson Lab, measuring the weak charge of the proton via parity-violating electron scattering, was commissioned in 2010 and is ready to take data. Atom and ion trapping and cooling methods play an increasingly important role in fundamental symmetry experiments, and Canada appears to be particularly well represented. The ALPHA collaboration has successfully produced anti-hydrogen at CERN, and in 2010 has observed candidate events for anti-hydrogen trapping. At the TITAN facility at TRIUMF, a first proof-of-principle experiment observing electron-capture in a Penning trap has been conducted. Li ions stored and electron-cooled in the storage ring TSR in Heidelberg were used to measure relativistic time dilation, testing Lorentz invariance. Finally, the TRINAT atom trap facility at TRIUMF continued its series of correlation measurements with laser-cooled and trapped beta-emitters, measuring the neutrino asymmetry in polarized ^{37}K , and testing for tensor interaction in ^{80}Rb , putting new, complementary limits on right-handed currents and tensor interactions, respectively. The 2006 Bonner Prize of the American Physics Society went to Ian Towner and John Hardy for their precise measurements and analysis of superallowed beta decay.

3.3.5 The road ahead: The next five years

In the coming five years, we will see a good mix of continuing, proven efforts, experiments which enter data-taking mode, and the development of new initiatives. ISAC based groups will continue to improve lifetime, branching ratio and Q-value measurements, as will the CPT group working at Argonne National Lab. The TRINAT group will push beta-neutrino correlation measurements to the 0.001 level, and the CPT group should finish a correlation measurement with $^8\text{Li}^+$ in a Paul (ion) trap. ALPHA will move on from anti-hydrogen trapping to performing microwave spectroscopy, searching for violations of the CPT symmetry. The Qweak experiment will be in full swing and deliver the most precise low-energy weak neutral current measurement to date. The TREK collaboration will exploit the low-intensity phase of J-PARC with searches for lepton flavour violation and heavy sterile neutrinos, and in 2014 or 2015 the TREK experiment will start taking data. TITAN EC will make the first in-trap branching ratio measurement for an isotope relevant to double-beta decay, ^{100}Tc . The francium laser trapping facility will become operational at ISAC, and focus on measuring the anapole moment in a chain of isotopes, giving insights into the parity violating weak hadronic interaction in nuclear matter. RnEDM at ISAC aims at a proof-of-principle measurement of a permanent electric dipole moment in radon. Both the Fr and Rn work will rely on the routine delivery of beams from actinide targets. Finally, while making progress on establishing an ultra-cold neutron facility at TRIUMF, a first neutron EDM measurement will be carried out at Osaka, perfecting the techniques envisioned for an upgraded version

at TRIUMF. All of these efforts either push the frontier in fundamental symmetries, or pave the way to do so in the following 5 year period. To accomplish this body of work, a modest increase in available FTEs is anticipated, as well as operating grants amounting to roughly \$ 2,800,000.

3.3.6 Further down the road: The 10-year horizon

Fundamental symmetry experiments are demanding and long-term. Many of the efforts that are now in development will come to fruition in the period 2016-21. At this time, we expect to see precision spectroscopy on anti-hydrogen performed by the ALPHA collaboration, delivering a clean, direct test of CPT symmetry. Following the 12 GeV upgrade at Jefferson Lab, the Moller experiment will measure the weak charge of the electron with unprecedented precision, determining electro-weak parameters such as the Weinberg angle at low momentum transfer to a precision that is on par with the best measurements at the Z-pole. At J-PARC, TREK will complete the time reversal violation test. Two cutting-edge searches for permanent electric dipole moments will be in full swing at TRIUMF: RnEDM will carry out its production run, using high doses delivered by the actinide targets, and a high flux of ultra-cold neutrons will allow to push the limit on or discover the EDM of the neutron. One of the two laser-trapping facilities at TRIUMF, TRINAT will tackle the ‘D’ coefficient in nuclear beta decay, sensitive to sources of time-reversal violation relatively unconstrained by EDM experiments. The other, FrPNC will attempt to measure the weak charge of francium via optical spectroscopy, with sensitivity to physics beyond the Standard Model complementary to Moller. A francium EDM experiment could commence towards the end of this period. Finally, the GRIFFIN gamma array at ISAC would increase the γ - γ coincidence efficiency 300-fold and revolutionize branching ratio measurements of high-Z superallowed beta emitters.

3.3.7 Priorities for the Canadian fundamental symmetries community

The Canadian fundamental symmetry community is diverse and involved in numerous efforts in and outside of Canada, collaborating with colleagues from around the world. With given resources, budgetary and in terms of highly qualified personnel, the community must focus on projects that play to the particular strengths of the Canadian researchers, while, at the same time, being open to new, exciting developments as they arise. An example of the latter is the possibility of a new type of ultra-cold neutron source at TRIUMF using superfluid He.

ISAC, as a world-leading ISOL facility, already houses several high-profile fundamental symmetry experiments, with the imminent addition of more. High availability of intense actinide beams, e.g. radon and francium, will be critical for the success of these projects. The vitality of the ISAC program ensures that Canada will have world-class efforts in fundamental symmetries at home. The combination of facilities available, advanced gamma arrays, ion traps, and neutral atom traps is unique in the world.

Parity-violating scattering experiments have a long tradition in Canada. This work has shifted to Jefferson Lab, where Canadian involvement is very significant, and will produce excellent return in the next decade.

Similarly, the Canadian contribution to the anti-hydrogen efforts at CERN is very strong, and in the upcoming precision spectroscopy phase their expertise will be crucial. Additional projects with Canadian involvement are located at Argonne, J-PARC, and the SNS. For relatively modest budgets, they provide breadth, international exposure, and training of Canadian students at state-of-the-art facilities around the world, and are an important component of the overall effort.

3.3.8 Theory for fundamental symmetries

In this brief paragraph we comment on the collaboration between experimentalists and theorist in this particular field. The situation is somewhat special since many fundamental symmetry experiment use the techniques of nuclear and atomic physics, but they try to address questions generally associated with particle physics. In Canada, there are numerous particle theorists, mostly phenomenologists, who work on subjects highly relevant to this field. In addition to nuclear theorists such as Peter Blunden (Manitoba), the work of Max Pospelov and Adam Ritz at the University of Victoria, John Ng and Sean Tulin at TRIUMF, Andrzej Czarnecki at the University of Alberta, and Stephen Godfrey and Bruce Campbell at Carleton is of direct importance.

3.3.9 Experimental Program

3.3.9.1 Time reversal and CP violation: Permanent electric dipole moments and other searches

Time reversal violation and non-flavor-changing CP violation are among the hottest topics in searches for ‘new’ physics beyond the Standard Model. The CP violation in the Standard Model is 10 orders of magnitude smaller than is needed to generate the baryon asymmetry of the universe in the method outlined by Sakharov. Several low-energy experiments searching directly for T-violation (implied by CP violation from the CPT theorem) are described here, complementary to B physics and the possibility of CP violation in the lepton sector at T2K. The existence of non-zero permanent electric dipole moments would directly violate time reversal symmetry, independent of any need for radiative corrections or theoretical interpretation. In this field the overlap between atomic, nuclear, and particle physics is particularly strong. Canadian groups are very active in this field and well positioned to be part of breakthrough discoveries. The Canada-based experiments benefit from the unique capabilities at ISAC/TRIUMF: The atomic EDM measurements (radon, and possibly francium) rely on the actinide target to produce heavy isotopes of choice where the underlying T/CP-violating interactions are strongly enhanced, and benefit from the availability of advanced gamma arrays for detection. TRIUMF’s cyclotron will also be the backbone of a high-density ultra-cold

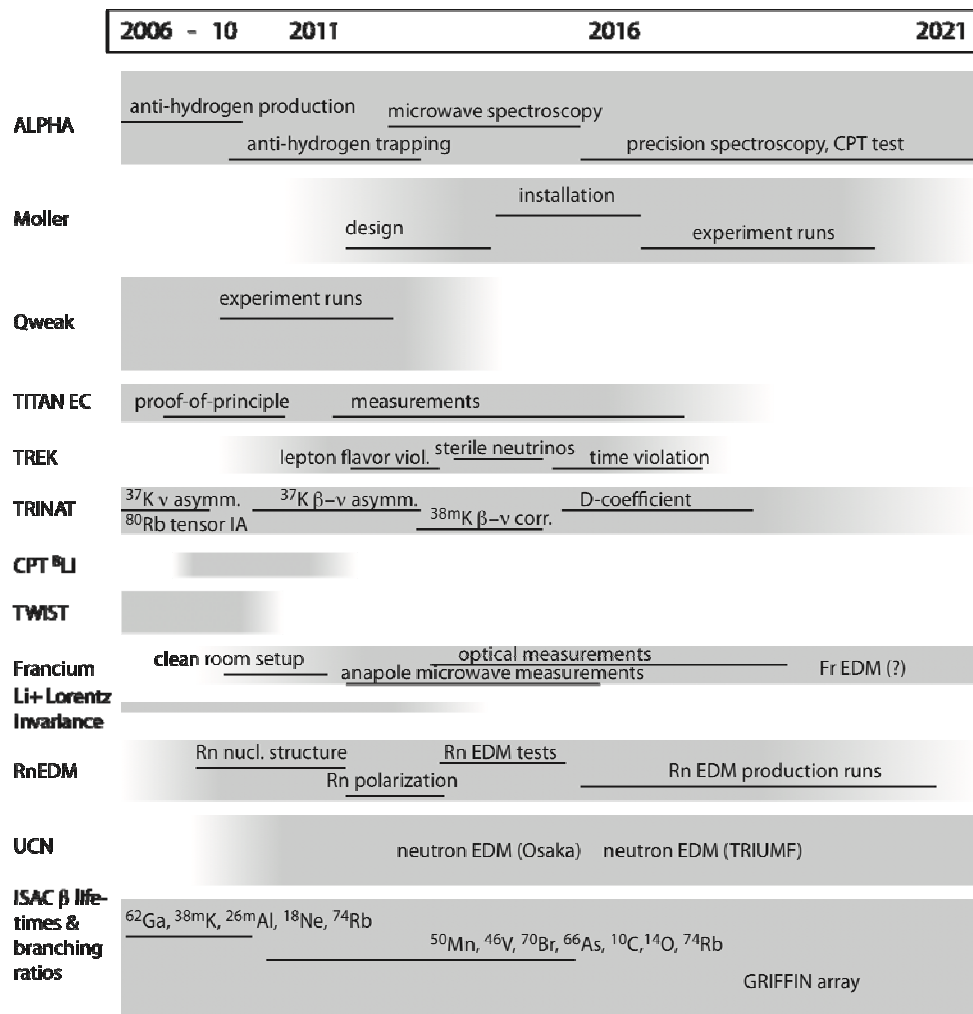

Fig. 3.3.1. Projected timelines for fundamental symmetry experiments in Canada or with Canadian participation; the vertical thickness of the bar is a rough indicator of Canadian FTEs (grant eligible, postdocs and graduate students). As a scale, the ALPHA bar corresponds to 10 FTEs.

neutron facility, enabling a competitive neutron EDM search. These efforts are complemented by the TREK effort in Japan, where Canadian scientists contribute their expertise in detector design.

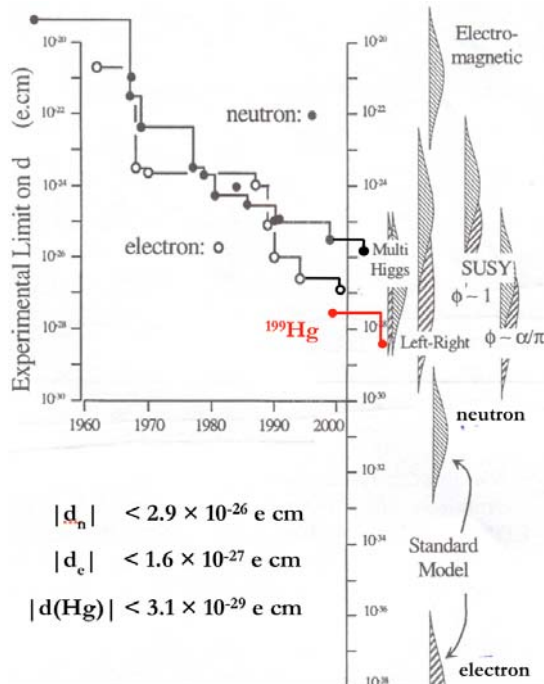

Fig. 3.3.2. Experimental limits on permanent electric dipole moments. Based on Pendlebury & Hinds, NIM A 440, 471 (2000)

3.3.9.1.1 The ^{223}Rn EDM experiment

Guelph, TRIUMF; U Michigan

In octupole-deformed nuclei, the induced atomic EDM can be strongly enhanced relative to the underlying T/CP violating interaction. In the radon isotopes, this enhancement is estimated to be on the order of 1000, making them an excellent candidate to improve limit beyond the recent results in mercury. An effort is underway at TRIUMF to search for an EDM in odd-A radon isotopes. An experimental facility has been established in the ISAC hall. With the actinide target, first measurements will focus on nuclear structure studies to identify the most suitable Rn isotope for EDM, using the 8π spectrometer. The aim is to establish the energy splitting of the parity doublet states predicted to accompany octupole deformation, a key parameter in the enhancement of the atomic EDMs. After the best candidate isotope is identified, Rn will be polarized via spin-exchange collisions with optically pumped Rb (Tardiff et al., Phys. Rev. C 77, 052501, 2008). Unlike in conventional EDM experiments, the Larmor precession of the radioactive Rn atoms in the presence of magnetic and electric fields (5 kV/cm) will be detected via the anisotropy of γ rays, using the TIGRESS or GRIFFIN array. Over 100 days, 10^{12} γ rays can be detected, yielding a competitive measurement.

Currently, there are 5.6 FTE (GE 2.2, PDF 1.7, GS 1.7). With the anticipated availability of beam from the actinide target in late 2010, nuclear structure measurements with the 8π spectrometer will commence to identify the optimal isotope for RnEDM (2010-12). Polarization studies with Rn will follow in 2012/13 and an initial Rn EDM experiment is planned for 2013-15. A production Rn EDM run will require high-intensity beams and will likely occur in the 2015-20 period.

- *Demonstration of the online collection and transfer of radioactive noble gas isotopes (S.R. Nuss-Warren et al., Nucl. Instrum. Meth. Phys. Res. A 533, 275 (2004)).*
- *Optimization of the collection foil for implanting the radioactive noble gas atoms (T. Warner et al., Nucl. Instrum. Meth. Phys. Res. A 538, 135 (2005)).*
- *Demonstration of Rn polarization and measurement of relaxation rates (E. R. Tardiff et al., Phys. Rev. C 77, 052501(R) (2008)).*

3.3.9.1.2 T-violating transverse muon polarization in the $K^+ \rightarrow \pi^0 \mu^+ \nu_\mu$ decay

UBC, TRIUMF, U Saskatchewan, U Montreal, U Manitoba; Japan, USA, Russia, Vietnam, Thailand

The observation of transversely polarized muons in kaon decay constitutes a very sensitive test for T-violation as spurious effects from final state interactions are small. Transverse polarizations in the range of $P_T \approx 10^{-3} - 10^{-5}$ are above the predicted Standard Model contribution (10^{-7}) and final state interactions (10^{-5}), and hence constitute a sensitive probe of physics beyond the Standard Model, in particular for exotic scalar interactions, e.g. a multi-Higgs doublet or SUSY with R-parity violation or large squark mixing. The simultaneous observations of P_T in $K_{\mu 3}$ decay ($K^+ \rightarrow \pi^0 \mu^\pm + \nu_{\mu 2\gamma}$) and $K_{\mu 2}$ decay ($K^+ \rightarrow \mu^\pm + \nu_\mu \gamma$) could allow a determination of the new physics involved since the sign of the P_T value for $K_{\mu 2\gamma}$ in the multi-Higgs model is opposite to that predicted by the SUSY (squark mixing) model. The international TREK collaboration is preparing this experiment at the J-PARC facility in Japan, aiming for $P_T \approx 10^{-4}$ in about 6 months of runtime. An upgraded version of the KEK E246 detector will be used, with a new fiber target provided by the Canadian collaboration.

Current FTE is 4.9 (GE 3.9, PDF 1), but graduate students are expected to join once the hardware is installed on the floor and the low intensity lepton flavour violation experiment begins data taking. The UBC TREK group currently has one student working on his Honours thesis project. Using the low-intensity beam at J-PARC the lepton flavor violation experiment is planned for 2012-13, and a search for heavy sterile neutrinos in 2013-14. The T-violation experiment requiring the intensity upgrade is envisioned to take place in 2014-16.

3.3.9.1.3 Neutron EDM using a new TRIUMF UCN facility

U Winnipeg, U Manitoba, TRIUMF, UNBC; Japan, USA

The planned UCN source at TRIUMF has the potential to provide unprecedented flux of ultra-cold neutrons, making it suitable, among other experiments, for neutron EDM searches.

UCN have such low kinetic energy that they are totally reflected from the surfaces of a variety of materials. Thus, they can be highly polarized and stored in material bottles for long periods of time, allowing low-field NMR experiments to be conducted with high

precision. These methods form the basis of the best neutron EDM measurements to date, and the increased density of UCN, together with an optimized apparatus provide the opportunity for an improved experiment. The room-temperature setup is being developed at RCNP (Osaka) and has several unique elements such as a new magnetic field geometry based on a spherical coil, optimization of the experimental volume to reduce systematic effects due to the accumulation of geometric phase, and a xenon buffer-gas comagnetometer. The UCN facility can be used for other experiments, including neutron-antineutron oscillations. These are produced in $\Delta B=2$ GUT's, and also in some versions of R-parity-violating SUSY.

Current FTE is 7.5 (GE 5.4, PDF 1.1, GS 1), expected to rise as students join. The new UCN source will be established at RCNP in 2011-12 with the goal of demonstrating the required density gains, and a first EDM experiment is expected there between 2012 and 2014. The installation and commissioning at TRIUMF is expected earliest in 2015, with a goal of reaching a sensitivity of 10^{-27} e-cm and ultimately 10^{-28} e-cm (2011).

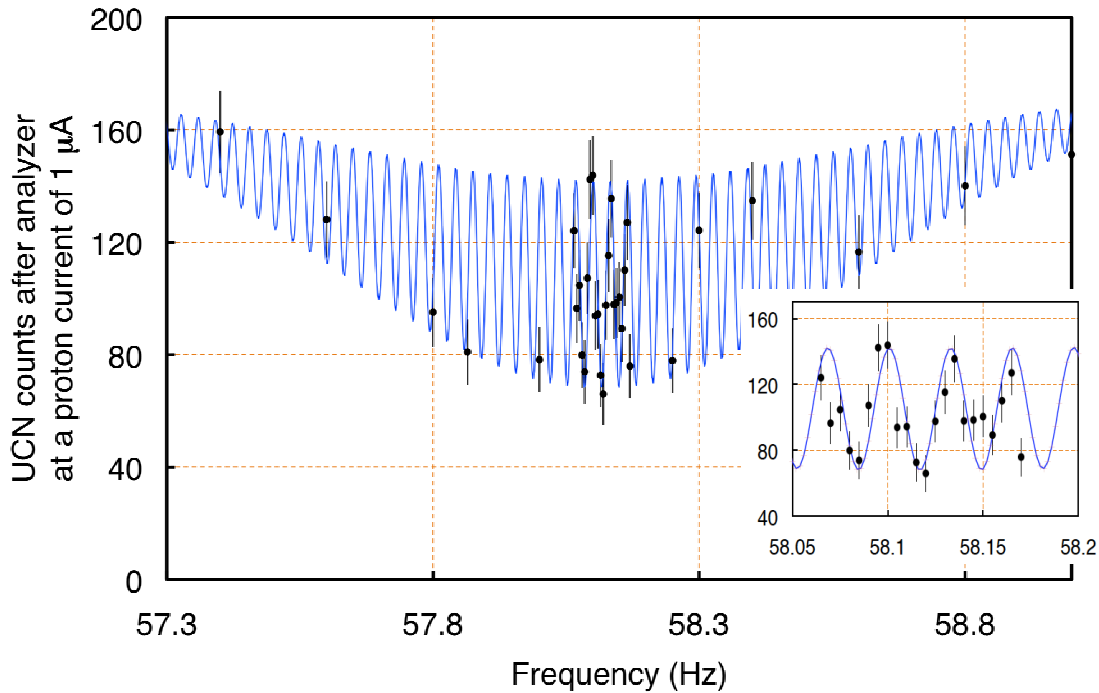

Fig. 3.3.3. Low-field NMR with ultra-cold neutrons; Ramsey resonance spectrum indicating achievement of $T_2 > 30$ sec ($H_0 = 20$ mG and $T_c = 30$ s).

3.3.9.1.4 Electron EDM in laser-trapped francium

TRIUMF, U Manitoba; LBNL, Maryland

The francium laser trapping facility in preparation in the ISAC hall at TRIUMF will provide a sample of 10^7 or more trapped, cold (< 100 μK) Fr atoms. Scientist at Lawrence Berkeley Lab have recently published a proof-of-principle experiment for measuring EDM in Cs in a cold-atom fountain (Amini et al., Phys Rev A75, 063416, 2007). They

are now establishing a larger collaboration for a full-fledged Cs experiment. Just like atomic parity violation, EDM are significantly enhanced in heavy atoms and in the Fr atom, underlying T-violating interactions are amplified by an order of magnitude relative to Cs, where a sample of $\approx 10^{14}$ Fr atoms needs to get interrogated in the fountain. The LBNL group has submitted a letter of interest to TRIUMF for a Fr fountain EDM experiment. At least near-competitive results in a Cs precursor should be obtained first. Electron EDMs are produced in many, though not all, models that produce nuclear and neutron EDMs, so their measurement is complementary.

3.3.9.2 CPT and Lorentz violation

CPT invariance and Lorentz symmetry are at the very foundation of our current description of nature, as quantum field theories are firmly based upon these principles. However, in string theory and also in quantum gravity, which unifies the standard model of particle physics with general relativity in a ‘theory of everything’, CPT and Lorentz violation are frequently assumed. As low-energy experiments are, relatively speaking, not that much further away from the Planck scale as are colliders, the former play a very significant role in this field, driven by the extreme precision that can be reached mostly with laser and microwave-based measurement techniques. Canada is strongly involved in the high-profile quest for the trapping of anti-hydrogen, having sizeable collaborations in both the ALPHA and the ATRAP efforts at CERN. Lorentz violation can be tested by accurate measurements of Doppler shifts of relativistic ions in storage rings.

3.3.9.2.1 Trapping anti-hydrogen and searches for CPT violation: The ALPHA project

TRIUMF, UBC, SFU, Calgary, York; CERN, Denmark, USA, UK, Brazil, Japan, Israel

The assumption that reality is invariant under CPT – the symmetry between left-handed particles and right-handed antiparticles evolving backwards in time – is largely based on the success of quantum field theories. Whether this CPT symmetry is exactly conserved is thus an important experimental question. A comparison of the properties of hydrogen and antihydrogen can potentially provide the most stringent test of this symmetry for baryon-lepton systems. The Antiproton Decelerator was built at CERN expressly to study this physics, and the ALPHA project is one of its principal experiments, receiving approximately 1/3 of the available beam time/year. The present program aims at developing a trap for antihydrogen atoms which will enable precision measurement of their 1s-2s atomic transition and their ground state hyperfine interval. Measurements of these properties in hydrogen are among the most precise in experimental physics. The ALPHA collaboration has successfully introduced a new type of nested trap where a Penning trap for anti-protons and positrons is overlapped with an octupole trap that will confine the neutral anti-hydrogen via its magnetic moment. In 2010, the collaboration reported candidate events for trapped anti-hydrogen. The Canadian contingent is taking a lead on preparing high-precision microwave spectroscopy for comparisons between the hyperfine structure of anti-hydrogen and hydrogen.

Currently the FTE is 9.9 (GE 3.9, PDF 1, GS 5), which constitutes more than

one third of the entire ALPHA collaboration. In the near future (2010-11), the collaboration plans to confirm the trapping of anti-hydrogen and increase the number of trapped anti-atoms. In addition, first microwave spectroscopy studies will proceed. In 2012-13, a new apparatus will be commissioned which is optimized for spectroscopy, and from 2014 onward, precision spectroscopy is anticipated, leading to a direct CPT test.

- *Andresen et al., Evaporative Cooling of Antiprotons to Cryogenic Temperatures, Phys. Rev. Lett. 105, 013003 (2010)*
- *Andresen et al., Formation Dynamics in an Anti-atom Trap, Physics Letters B 685,141(2010).*

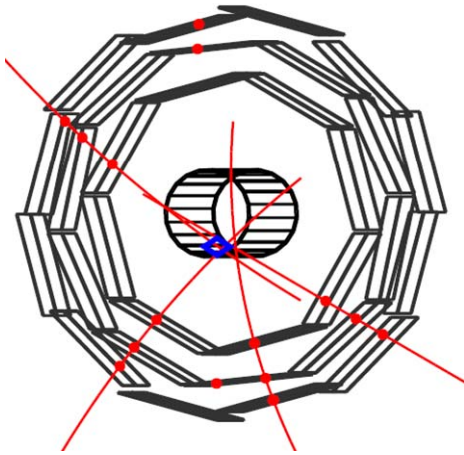

Fig. 3.3.4. Anti hydrogen trapping candidate annihilation event recorded in the Si detector during the rapid ramp-down of the ALPHA magnetic trap. The diamond symbol is the reconstructed vertex. The detector electronics and reconstruction software are the responsibility of ALPHA-CANADA.

3.3.9.2.2 *Sub-doppler laser spectroscopy on relativistic beams and tests of Lorentz invariance.*

U Manitoba; GSI, Mainz, MPIK Heidelberg, MPQ Munich

The determination of the second-order Doppler shift in fast moving atoms or ions is still the most precise way of testing relativistic time dilation, decades after Ives and Stilwell used this method to confirm time dilation for the first time. Experiments with Li^+ ions confined in storage rings (first TSR at MPIK, now the ESR at GSI) at up to 34% of the speed of light provide the most stringent test of the time dilation in special relativity and also constrain Lorentz-violation, as parametrized e.g. in the Standard Model Extension (SME) framework by Kostelecky and co-workers. The TSR experiment has set best limits on parameters in the photon and the particle sector of the SME, and upcoming measurements at the ESR will give access to a whole range of SME parameters that have no constraints at all.

- *S. Reinhardt et al., Test of relativistic time dilation with fast optical atomic clocks at different velocities, Nature Physics 3, 861 (2007).*
- *C. Novotny et al., Sub-doppler laser spectroscopy on relativistic beams and tests of Lorentz invariance. Phys Rev A 80, 022107 (2009).*

3.3.9.3 Neutral current weak interactions

The neutral current weak interaction is generally masked by much larger electromagnetic processes. The parity violating nature of the neutral weak current can be harnessed to isolate it and conduct very sensitive experiments testing the Standard Model by confirming the ‘running’ of the Weinberg angle (see Fig. 3.3.5) and determining the parity-violating electron quark couplings. At the same time, these experiments search for ‘new’ physics such as extra gauge bosons, leptoquarks, and signatures of supersymmetry. There is a long tradition of parity-violating scattering experiments in Canada, and with the strong involvement in Qweak and MOLLER, this line of research is stronger than ever. Atomic parity violation work using the actinide target at ISAC is the goal of the newly formed FrPNC collaboration.

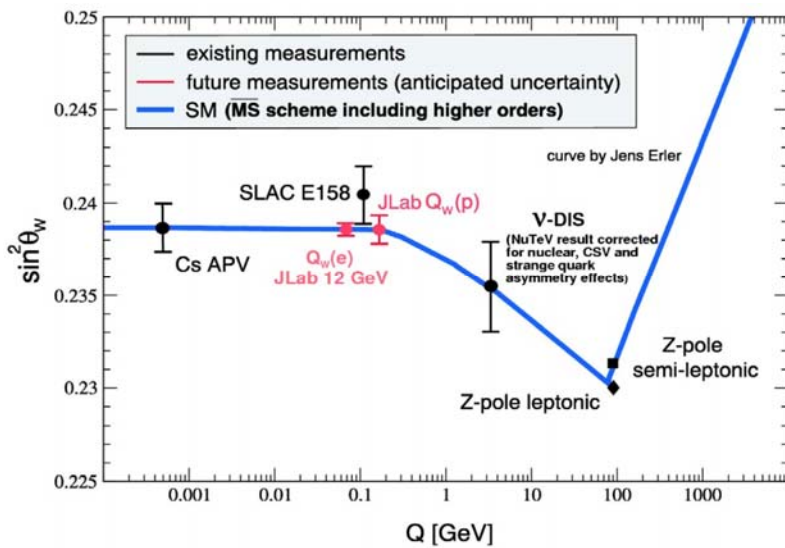

Fig. 3.3.5. The running of the Weinberg angle.

While the goals of these efforts looks similar (especially when interpreted as $\sin^2(\theta_w)$ measurements), it must be noted that the physics is highly complementary: The weak charge of the electron (MOLLER) is insensitive to leptoquarks; atomic parity violation, which largely measures the neutron weak charge, is sensitive to leptoquarks, but not supersymmetry; the latter is probed by the proton weak charge (Qweak).

3.3.9.4 The weak charge of the proton: The Qweak experiment at Jefferson Lab

U Manitoba, U Winnipeg, TRIUMF, UNBC; [USA](#),

The Canadian group plays a leading role in the Qweak experiment at Jefferson Laboratory, which will make a precision measurement of the proton's weak charge, via parity violating electron proton scattering at low momentum transfer. The Qweak experiment will determine the proton's weak charge with 4% combined statistical and systematic errors, leading to a 0.3% measurement of the weak mixing angle. The

Standard Model makes a firm prediction of its running from the Z pole down to low energies, corresponding to a 10 standard deviation effect in our experiment. As a standalone measurement, the Qweak experiment will be competitive with any channel measured in the SLD and LEP programs at the Z resonance. A longitudinally polarized electron beam, a liquid hydrogen target, a room temperature toroidal magnetic spectrometer, and a set of detectors for the scattered electrons at forward angles are the key elements of the experimental apparatus. The toroidal magnetic field focuses elastically scattered electrons onto a set of 8, rectangular quartz Cerenkov detectors coupled to photomultiplier tubes, which are read out in current mode to achieve the high statistical precision required for the measurements. A 3-stage tracking detector system is introduced for auxiliary measurements at low beam current to measure the Q2 acceptance, needed to interpret the asymmetry data. The Canadian group has designed and supplied the high power toroid magnet QTOR, and mapped it precisely; prototyped/built a novel set of multistrip diamond electron detectors and a quartz scanning detector to verify the counting mode and current mode measurements of the Q2 acceptance; played a leading role in prototype testing and development of the final Qweak main Cerenkov detectors; low-noise preamps/ADCs, luminosity monitors were contributed by TRIUMF.

The experiment was installed in Jefferson Lab Hall C commencing in October, 2009 through July, 2010, and it is scheduled to receive 431 days of beam from 2010 through 2012. Currently, FTE is 10 (GE 4.8, PDF 2.2, GS 3).

3.3.9.5 Parity-violating electron scattering at 12 GeV: The Jefferson Lab MOLLER experiment

U Manitoba, U Winnipeg, TRIUMF, UNBC; [USA](#)

The next generation parity-violating electron scattering experiment at Jefferson Lab will be measuring the weak charge of the electron by scattering longitudinally polarized electrons of positive and negative helicity off the electrons of a liquid hydrogen target. The objective in the experiment is to reach a precision five times better than in the E158 experiment performed at SLAC in terms of the ‘running’ of $\sin^2(\vartheta_w)$. Such a precision compares favorably with the precision attained in the two better experiments at the Z_0 pole. However the latter (one semi-leptonic, the other leptonic) differ in their result by three standard deviations and give predictions for the Higgs mass both excluded by a compilation of other measurement results. Clearly this requires elucidation through another experiment on the ‘running’ of $\sin^2(\vartheta_w)$. The MOLLER experiment with its anticipated accuracy constitutes another important search for physics beyond the Standard Model of leptons and quarks. The MOLLER experiment passed a number of important reviews and is being considered for inclusion in the DOE’s budget for FY 2012. The experiment will be mounted on the beam floor in Hall A after establishing a ‘parity-quality’ 11 GeV beam from the upgraded CEBAF.

Once the experiment moves from the conceptual phase to the design/construction phase, participation at the 10 FTE level (similar to the current Qweak involvement) is expected.

In early 2011 the CD0 request will be filed with the US Department of Energy; at the CD2 level (2013) major funding from DOE is expected, and installation could begin in 2015.

3.3.9.6 Atomic parity violation in laser-trapped francium

TRIUMF, U Manitoba; Maryland, William & Mary, Stony Brook, San Luis Potosi, New South Wales

In atoms, extremely weak electric dipole transitions between states of the same parity are induced by the parity-violating exchange of Z-bosons between the electrons and the quarks in the nucleus, an effect known as atomic parity violation (APV). By measuring this amplitude, one can study neutral-current weak interactions with atomic physics methods and search for ‘new’ physics such as extra gauge bosons and leptoquarks. APV is strongly enhanced in heavy atoms, but the atomic structure calculations necessary to extract the weak physics is only feasible in alkali atoms. In francium, the APV effect is 18 times larger than in Cs. However, Fr has no stable isotopes, must be produced at a radioactive beam facility such as TRIUMF's ISAC in Vancouver, and needs to be accumulated in a laser trap. The FrPNC collaboration has been formed to perform fundamental symmetries measurements with cold, trapped Fr at ISAC. In 2011, a electromagnetically shielded laser facility will be put on the floor in the ISAC hall. The Maryland group will move their existing laser trap apparatus to TRIUMF. Once Fr beams are available from the actinide target, first measurements will measure hyperfine anomalies (Bohr-Weisskopf effect) in a chain of neutron-deficient Fr isotopes/isomers, which will help shed light on neutron distributions in the Fr nuclei. Starting in 2012, online work toward parity violation experiments will take place. The Maryland group will lead efforts to measure the anapole moment in Fr, a parity-violating nuclear moment that arises from parity-violating hadronic interactions inside the nucleus, using a novel microwave scheme. Optical work on the 7s – 8s transition will focus on measuring the nuclear spin independent APV amplitude.

Current FTE is 2.2 (GE 1.2, GS 1). Once the trapping facility is established in 2011, a FTE of 4 is expected, including two graduate students. Given the availability of Fr beams from the actinide target, first experiments with trapped Fr atoms could start in late 2011. The anapole moment measurements could start in 2012 and will take several years. In parallel, techniques for optical spectroscopy on 7s-8s line will be developed and in after 2014, a nuclear-spin independent atomic parity violation experiment will be ramped up.

- *D. Sheng et al., Preliminary studies for anapole moment measurements in rubidium and francium, J Phys B 074004 (2010).*

3.3.9.7 Unitarity of the Cabibbo-Kobayashi-Maskawa matrix

The weak interaction eigenstates are rotated against the quark mass eigenstates, parametrized by the Cabibbo-Kobayashi-Maskawa (CKM) quark mixing matrix. The unitarity of this matrix requires the sum of the absolute squares of any row of matrix elements to be unity. At present, the test on the first row is more precise than the others:

$|V_{ud}|^2 + |V_{us}|^2 + |V_{ub}|^2 = 1$. While V_{us} and V_{ub} are derived from high-energy experiments, V_{ud} is the domain of nuclear beta decay, more precisely the determination of the ft value of super-allowed $0^+ \rightarrow 0^+$ Fermi decays. V_{ud} is dominating ($|V_{ud}|^2 \approx 0.949$, $|V_{us}|^2 \approx 0.051$, $|V_{ub}|^2 \approx 1.5 \times 10^{-5}$), giving it a pivotal role in this important Standard Model test. V_{ud} is determined from the beta decay's ft value, which in turn is obtained from precise lifetime and branching ratio measurements. However, radiative corrections and isospin-breaking (Coulomb) corrections have to be taken into account, a significant complication. For quite some time, a puzzling 2.3σ deviation between the experimental value and unity existed. The large contribution of V_{ud} and the uncertainties in the corrections suggested that beta decay might be at fault. Somewhat surprisingly, recently a 5% increase in kaon decay branching ratios has led to a revision of V_{us} , such that $|V_{ud}|^2 + |V_{us}|^2 + |V_{ub}|^2 = 0.9999 \pm 0.0006$, in very good agreement with the Standard Model. Behind this success is a long series of careful beta decay measurements. Precise ft value determinations require three ingredients: lifetime measurements, branching ratios, and Q-values. These, together with the radiative/Coulomb corrections permit to determine a transition-independent Ft value from the experimentally measured ft value. The constancy of Ft across all measured superallowed Fermi decays is a powerful test of the conserved vector current (CVC) hypothesis, currently at the 1.3×10^{-4} level. The world-average of Ft in turn is used to determine V_{ud} . Canadian experiments at TRIUMF and at the Canadian Penning Trap at Argonne National Lab play a very prominent role in this endeavor, providing precision data on lifetimes, branching ratios and Q-values.

TRIUMF, Guelph, St. Mary, Simon Fraser

At TRIUMF, the 8π spectrometer and a dedicated lifetime measurement tape system are used for precision lifetime and branching ratio measurements. The TITAN mass measurement facility which has become operational in 2007 will take up measurements of Q-values by determining atomic masses of parent and daughter nuclei with high precision. In addition, collinear laser spectroscopy using the TITAN RFQ will contribute to determining the Ft value of ^{74}Rb , the heaviest superallowed Fermi emitter currently measured, by providing a charge radius measurement for this nucleus. The ISAC facility is exceptional in its ability to contribute to all aspects of the V_{ud} and CVC work. Recently, very precise lifetime and branching ratio measurements have been carried out on ^{26}mAl , using the new TRILIS laser ion source.

The branching ratio/lifetime group currently has 11.6 FTE (GE 3.4, PDF 2.3, GS 5.9). The collaboration has a long list of measurement to carry out over the next five years: ^{74}Rb branching ratio, ^{14}O lifetime, ^{10}C lifetime, and the branching ratio and lifetimes of ^{50}Mn , ^{46}V , ^{70}Br , and ^{66}As . There will be numerous other opportunities as new beams get developed at ISAC. In the period after 2016, the new GRIFFIN array has the potential to

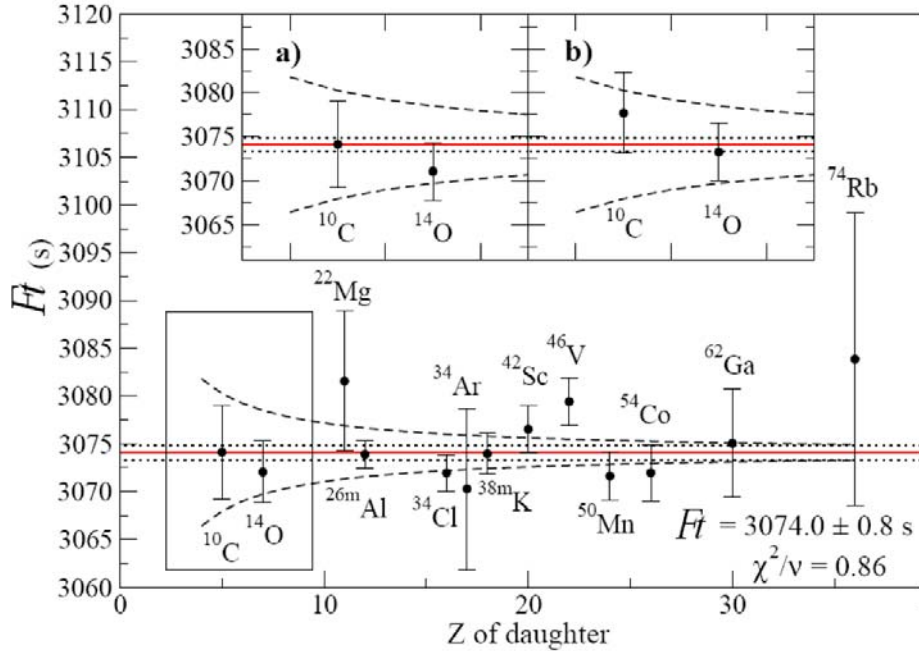

Fig. 3.3.6. Ft values of all measured superallowed $0^+ \rightarrow 0^+$ emitters. The Z – independence indicates the validity of the CVC hypothesis and the averaged Ft value determines V_{ud} .

revolutionize branching ratio measurements with its vastly improved γ - γ coincidence efficiency.

- ^{62}Ga superallowed branching ratio (B. Hyland et al, Phys Rev Lett 97, 102501 (2006)) - the first truly high-precision superallowed branching ratio measurement in the $A \geq 62$ region, overcoming the "Pandemonium" problem, and confirming the large isospin symmetry breaking effects predicted for the $A \geq 62$ superallowed decays.
- ^{38m}K superallowed branching ratio (K.G. Leach et al, Phys Rev Lett 100, 192504 (2008)) - identified the internal M3 gamma decay of ^{38m}K for the first time, changing the superallowed branching ratio by more than 16 times its previously quoted uncertainty and shifting the ft value (at the time the most precise for any of the superallowed decays) by a full sigma.
- ^{26m}Al superallowed half-life (P. Finlay et al., submitted to Phys Rev Lett (2010)) - an "ultra-high" precision half-life result (0.01%), a factor of 2 more precise than any other single superallowed half-life measurement. This measurement improved the world-average half-life for ^{26m}Al by a factor of 2.7, making it by far the most precisely determined experimental ft -value and corrected Ft value.

U Manitoba, McGill; Argonne Natl. Lab, Chicago, Northwestern

The Canadian Penning Trap at Argonne Natl. Lab has recently provided an improved Q -values for ^{22}Mg , where isospin mixing corrections can be expected to be smaller, and for

^{46}V . It has currently one of the more poorly determined Ft values in the lighter mass region.

FTE is currently 2.6 (GE 1.1, PDF 1.5).

- *G. Savard et al., Q value of the superallowed decay of ^{46}V and its influence on V_{ud} and the CKM matrix unitarity, Phys Rev Lett 95, 102501 (2005).*

3.3.9.8 Searches for right-handed currents, scalar and tensor interactions and exotic particles

3.3.9.8.1 Beta-neutrino correlations with trapped atoms and ion

TRIUMF, UBC, SFU, U Manitoba; Texas A&M, Tel Aviv

TRIUMF's atom trap (TRINAT) has pioneered the use of trapped atoms to measure beta decay correlations. There are two main technical features: The nuclear recoil escapes freely from the trap, and its momentum and that of the beta can be deduced, so the neutrino momentum can be determined directly. Also, the nuclei can be spin-polarized by optical pumping, with the spin polarization determined by atomic methods independent of the nuclear decays. Upgrades of two experiments are approved, a beta-neutrino correlation measurement that presently puts the best model-independent constraints on scalar interactions in the first generation of particles, and a spin-polarized experiment sensitive to a variety of new interactions. The goal is to reach sensitivity of 0.001 in several observables. This level of sensitivity could for example uniquely constrain left-right sfermion mixing in MSSM. Longer term activities aim at measuring an observable sensitive to time reversal by flipping the nuclear spin and the signs of the beta and recoil momentum (D-coefficient). The envisioned sensitivity would be 5×10^{-4} per week of counting. Though electric dipole moment searches constrain many models of extra time-reversal symmetry, phenomenological leptoquark tree-level exchange provides a source of time-reversal symmetry relatively unconstrained by EDM experiments.

FTE is currently 4.4 (GE 1.4, PDF 1, GS 2).

- *Complementary limits on tensor interactions from ^{80}Rb recoil asymmetry measurements (R. Pitcairn et al., Phys Rev C 79, 015501, 2009)*
- *Best general limits on scalar interactions in beta decay from beta-neutrino correlation in ^{38}K (A. Gorelov et al. Phys Rev Lett 94, 142501, 2005)*

McGill, U Manitoba; Livermore, Argonne, Chicago, Northwestern

The Canadian Penning Trap collaboration at Argonne has recently embarked on a measurement of beta-neutrino correlations in the decay of ^8Li stored in an ion trap. The nearly pure Gamow-Teller decay of ^8Li makes it very sensitive to tensor interactions. The light mass, large Q-value, and the fact that ^8Be immediately breaks up into two alpha particles of equal and opposite momenta results in Doppler shifts orders of magnitude larger than those sought in other beta-neutrino correlation experiments. Production and

transfer of the ^8Li ions into the Paul trap has been demonstrated. In the near future, the collaboration expects to measure the beta-neutrino asymmetry coefficient with a statistical uncertainty on the order of 1%.

Current FTE is 2.5 (GE 1, PDF 0.5, GS 1).

3.3.9.9 Muon decay

TRIUMF, UBC, Victoria, Regina

The TWIST experiment at TRIUMF is currently completing the most precise determination of the muon decay parameters via the measurement of the energy-angle spectrum of positrons from the decay of polarized muons. At the current, almost final state of data analysis, the decay parameters ρ , δ , and $\mathcal{P}_{\mu\xi}^{\pi\xi}$ are in agreement with the Standard Model prediction and the improvement compared to previous measurements is about one order of magnitude. The decay parameters measured by TWIST together with other observables put constraints on scalar, vector and tensor interactions for muons and electron of both left and right chirality. For example, in a left-right symmetric extension of the Standard Model, TWIST's result for the Michel parameter ρ puts the tight constraints on the mixing angle and mass of a heavy W boson.

Current FTE is 4.8 (GE: 1.7, PDF 0.9, GS 2.2). The data taking has finished, final analysis and dissemination are in progress.

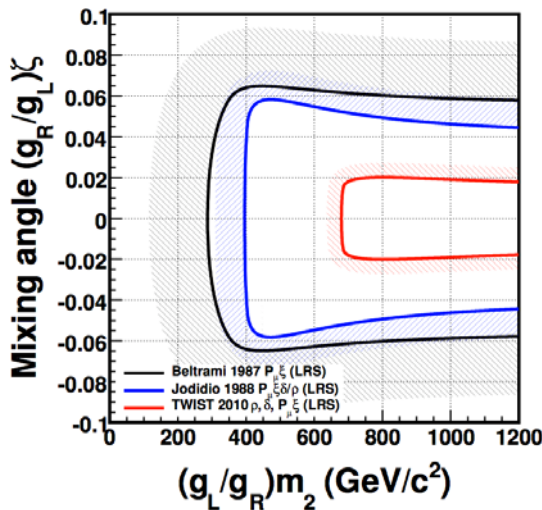

Fig. 3.3.8. Allowed region of mixing angle and heavy W mass in a left-right symmetric model as measured by TWIST

- *MacDonald et al., Precision measurement of the muon decay parameters, Phys. Rev. D. 78, 032010 (2008).*
- *Jamieson et al., Measurement of P_{μ} in polarized muon decay, Phys. Rev. D 74, 072007 (2006).*

3.3.9.10 Double beta decay nuclear matrix elements from in-trap spectroscopy

TRIUMF, UBC, SFU; Münster, TU Munich, Dresden, Giessen, Yale

The TITAN ion trap facility at TRIUMF is currently implementing a novel method to observe very weak electron capture (EC) decays inside a Penning ion trap. These decays are usually hard to measure due to a dominating beta background. The measurements aim towards the determination of transition nuclear matrix elements in 2-neutrino double beta ($2\nu\beta\beta$) decays. Knowledge of these matrix elements is essential for the theoretical description of these decays. The experiment opens the door to a new field of in-trap-decay spectroscopy.

FTE is 3.1 (GE 1.1, PDF 1, GS 1). A first measurement using in-trap spectroscopy for an isotope relevant to $2\nu\beta\beta$ decay (^{100}Tc) is anticipated in late 2011.

- *In-Trap Decay Spectroscopy of Radioactive Nuclei at TITAN/TRIUMF for a Determination of $2\nu\beta\beta$ -Matrix Elements, AIP Conf. Proc. Volume 1182, 100 (2009).*

3.3.10 Outlook

Canada has a very successful program in low-energy fundamental symmetry experiments which has produced many highlights in the recent past. Several new initiatives described in this document, if appropriately funded, will assure that the country's leadership role can be maintained. This will be particularly exciting in the LHC era when potential new discoveries at the energy frontier need to be complemented with low-energy studies.

3.4 Hadrons and QCD, Hadron Structure and Hadron Interactions

3.4.1 Introduction

The whole of nuclear physics relies on two fundamental interactions: Quantum Chromodynamics (QCD) and Electroweak physics, which in turn constitute the Standard Model (SM). The SM is without any doubt a cornerstone of modern physics. In this context, understanding the structure, the spectroscopy, and interaction of hadrons in terms of QCD is one of the main challenges of modern nuclear physics. QCD, the theory of how nucleon constituents – quarks and gluons –interact, is deceptively simple in its apparent structure, but the self-coupling of the gauge gluon fields introduces nonlinearities that have made a formal solution elusive. Renormalization group arguments insure that the overall coupling strength of QCD varies with the energy with which the system is probed: QCD is the first known theory where the running yields a charge that decreases at short distance (equivalently, at high energies). This remarkable effect is called *asymptotic freedom* and has been amply confirmed by experiments. Its

theoretical elucidation by Gross, Wilczek, and Politzer was awarded the 2004 Nobel Prize in Physics.

At high energies (> 10 GeV), the asymptotically free theory has been well-tested in scattering experiments. However, at low energies (< 1 GeV), QCD is not amenable to a perturbative solution, and is a strongly-coupled theory. In this text, we concentrate on phenomena whose energy scale is typically around 1 GeV, and that energy region is dubbed that of hadronic physics. In parallel with this effort to understand the dynamics of hadrons, a sizeable effort has been devoted to elucidate the structure of bulk, many-body, QCD through extensive investigations of its phase diagram. Canadian leadership has been manifest in both those directions, and this will extend into the future by building on strengths and successes. Examples of accomplishments of Canadians in hadronic physics include:

- Canadian leadership in measuring Strange-Quark Effects with G-Zero at the Thomas Jefferson Laboratory (JLab). Although very little is known about the role played by strange quarks in the proton and neutron, tantalizing evidence from a number of experiments indicate that they may be important. By exploiting a set of unique “parity-violation” measurements, the G-Zero experiment was able to study the contributions from strange quarks to the basic properties of the proton, such as its magnetic moment and electric charge distribution. The full experiment took more than 15 years to accomplish, with tons of new equipment and exclusive use of one third of the experimental space for over two years at JLab. In addition, it benefited from the assistance of nearly 50 undergraduates, graduate students and postdoctoral researchers and hundreds of support personnel. Now, the G-Zero experiment is publishing the first of several of papers detailing its final conclusions. Led by Willem van Oers at the University of Manitoba, Canadian scientists based at TRIUMF, and the Universities of Manitoba, Northern British Columbia and Winnipeg have played an important role in the G-Zero experiment. In addition, Canadian funding agencies (NSERC, NRC) have played a key role in subsidising the many subsystems needed for the operation of G-Zero.
- Canadian leadership in the establishment, review, and approval of the JLab 12 GeV Scientific Program. The doubling in energy of JLab (to be completed in 2013 with the delivery of the first beam) to 12 GeV will seek to further our understanding of the transition between the hadronic and quark-gluon degrees of freedom in nucleons and nuclei. Canadians are on the frontline and carrying spokesperson responsibilities for two A-rated approved experiments at JLab: GlueX (Lolos, Regina), and Fpi-12 (Huber, Regina)¹.
- Canadian leadership in the first non-quenched lattice QCD calculation. Owing to a set of technical breakthroughs, lattice calculations that genuinely include dynamical quarks have become accessible in the last five years. The Canadian contribution (Trottier, SFU) to this large collaborative effort has been crucial, in

¹ Notably, A-rated experiments represent but 10 – 15% of all approved experiments.

the form of analytical determination of fundamental parameters of the standard model, and in the development of a highly-improved lattice discretization scheme for charm quarks.

- Canadian leadership in the theoretical modeling and characterization of the quark-gluon plasma (QGP) formed at RHIC (Relativistic Heavy Ion Collider, Brookhaven National Lab.). Canadian theorists (Gale, Jeon, Moore, McGill) have led the effort to evaluate the complete electromagnetic emissivity of the quark-gluon plasma and of the hot hadronic matter formed in relativistic nuclear collisions. These in turn have proven invaluable to evaluate the temperature of the QGP at RHIC.

3.4.2 EXPERIMENTAL STUDIES OF HADRON STRUCTURE

Experimentally, a lot of effort worldwide has been devoted to elucidating the internal structure of the nucleon and of hadrons in general. Canadians have had a very significant role in this work. The Canadian effort there has been manifest at laboratory facilities like the U.S. Thomas Jefferson National Accelerator Facility in Newport News, Virginia (JLab), and at MAMI (Mainz). JLab is currently upgrading its electron beam to an energy of 12 GeV (from 6 GeV), to access new domains of Q^2 . The new facility will be operational in a couple years. A large amount of effort is devoted to experimental studies of nonperturbative QCD at energy scales germane to hadronic physics. Concentrating on the period covered by this long range planning exercise, some key projects where Canadian leadership is manifest are briefly summarized below.

3.4.2.1 The scope of the Jefferson Lab 12 GeV Upgrade

It is well known that inclusive electron scattering at high momentum and energy transfer is governed by elementary interactions with quarks and gluons. In the energy regime of asymptotic freedom, where perturbative QCD (pQCD) is applicable, it has proven very robust and accurate. But our understanding is fragmented, particularly in the confinement region of QCD. This regime remains an outstanding problem of QCD and its solution is one of fundamental importance. One obstacle to our improved comprehension is the sparse coverage and inconsistent quality of the experimental data set. On a strategy to remedy this situation:

- In QCD, in addition to the colour-singlet combinations of $q\bar{q}$ (mesons) and qqq (baryons), others are also possible, such as $q\bar{q}g$ (hybrid mesons) and gg or ggg (glueballs), states collectively known as “gluonic excitations”. The experimental confirmation of any gluonic excitation state would be a breakthrough for our understanding of QCD, but this goal has remained elusive despite several decades of study.
- Another obstacle to our improved comprehension is that exclusive and semi-inclusive deep inelastic scattering studies at large Q^2 are difficult because they require continuous, high luminosity electron beams, and detectors with good

particle identification and reproducible systematics. The experimental data needed to comprehend how QCD transitions from the non-pQCD (confinement) region to the pQCD (asymptotic freedom) region either simply do not exist, or they are of such poor quality that any conclusions drawn from them are suspect.

The Jefferson Lab (JLab) 12 GeV Upgrade is intended to address these issues, with a doubling of the maximum electron beam energy to 12 GeV, and the construction of new experimental apparatus. The 12 GeV Upgrade was identified in the 2007 NSAC Long-Range Plan as the highest priority for the U.S. Nuclear Physics program. Jefferson Lab is one of the leading nuclear physics laboratories in the world, with approximately 1,300 scientists from around the world conducting experiments there. Canadians have had a long and distinguished association with JLab and their activities as part of the “12 GeV Upgrade” span Halls A, C, and D. The facility is designed such that up to three halls can receive electron beam, of different energies, simultaneously. The upgrade received formal construction approval from the DOE in the fall of 2008. Advanced funds for the upgrade were received as part of the U.S. infrastructure stimulus funding plan. Most elements of the project are now either under construction or in final planning stages. The first higher energy beam is presently scheduled to be delivered in 2013, with the full scientific capabilities expected to be operation in 2015.

3.4.2.2 Canadian Contributions to the GlueX Experiment

The main Canadian effort is related to the GlueX experiment, and has started in earnest in 2000, with the last several years having seen intense activity leading to the approval of the funding of the Upgrade and starting of construction. GlueX is one of only two experimental proposals within the 12 GeV Upgrade scientific program that have been highlighted for their “discovery potential” by the DOE Science and Technology international review committee for the JLab Upgrade. The leading role of Canadians within GlueX and the Hall D Collaboration is further emphasized by the fact that Lolos is

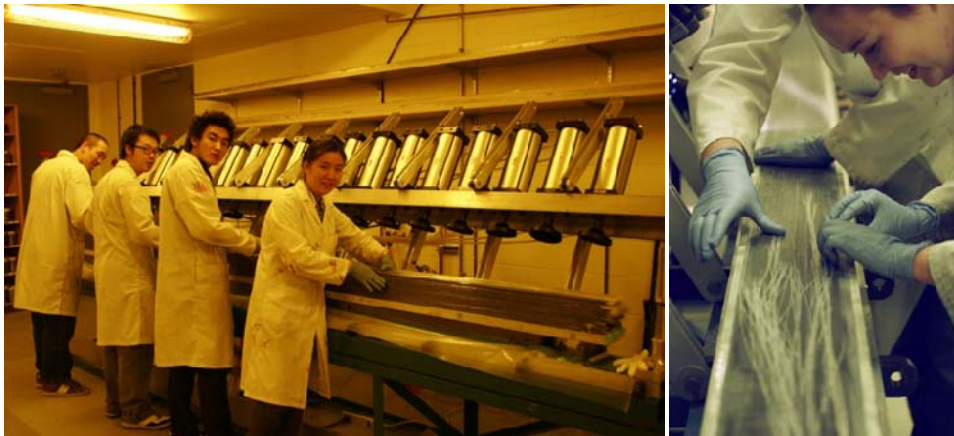

Fig. 3.4.1. GlueX Barrel Calorimeter (BCAL) construction by students at the University of Regina.

the GlueX Deputy Spokesman and Papandreou (both from Regina) is the Chair of the Hall D Collaboration Board.

The primary scientific objectives of GlueX are to identify the existence of exotic hybrid mesons by determining their unique J^{PC} numbers, to measure their masses and decay channels, and then map out the spectrum of the nonets, including $g\bar{s}s$ hybrid states. Conventional mesons (flux tube in its ground state) that are made from u, d, and s quarks are grouped in nonets, each characterized by a given J^{PC} combination, as determined by the relative orientation of the spins of the quarks and their orbital angular momentum. Hybrid mesons (the gluonic flux tube between the quarks is in an excited state) obtain their quantum numbers from the addition of the angular momentum quantum numbers of the gluons to those of the two quarks. This additional orbital angular momentum can result in both ordinary as well as exotic combinations of hybrid mesons. Hybrid mesons will mix with all other non-hybrid states of same J^{PC} decaying into the same mode. Thus, a direct and unequivocal identification of such states as a hybrid meson is not possible. A better choice, experimentally, is to search for so-called exotic states. Glueballs are the most exotic of all QCD states. Exotic hybrid mesons, on the other hand, cannot mix with any other $q\bar{q}$ state and can be uniquely identified by determining their J^{PC} quantum numbers.

The central piece of the Hall D experimental equipment is a hermetic, multi-particle detector with a 2.25 T solenoidal magnetic field. One of the most critical detector components is the Barrel Calorimeter (BCAL). Due to the importance of the BCAL and the long construction time required, the UofR GlueX group was the first research group at JLab to be fully funded for 12 GeV detector construction. This device will be responsible for the detection, identification and total energy measurement of all photons and charged (π , K, p) particles within its detection volume. The dynamic energy range for the photons of interest spreads from as low as 40 MeV to as high as 4 GeV. Since the four-momenta of all the final state particles must be determined, a sufficient fraction of the energy from the electromagnetic showers produced must be contained within the BCAL to allow the correct reconstruction of the photon four-momentum. The Canadian responsibilities within GlueX cover all R & D tasks in hardware related to the BCAL and its readout sensors, as well as the software associated with detector integration simulations and event reconstruction, and eventually data analysis. Within the previous 5-year plan, the major Canadian contributions to GlueX are:

- Completed all R & D on BCAL module construction with two full-scale prototypes built and tested.
- Performed a small-scale beam test of the first prototype at TRIUMF M11.
- Organized and mounted a test beam experiment at JLab with the first full-scale prototype, the first such major effort by GlueX.
- Completed the exhaustive testing of all types of scintillating fibers available in the market and played the main role in the final selection of the production fibers.
- Passed all technical and quality assurance reviews by JLab and the DOE and was awarded non-domestic sole-source status by the DOE, a difficult process given the importance of the BCAL on GlueX and GlueX on the Upgrade.

- Was awarded a U.S.\$1,130,000 contract with DOE for the construction of the BCAL, which will be completed by fall 2012.
- Completed the first and second stages of the intensive R & D on silicon-based photo-sensors that solve all the read out issues of the BCAL within the 2.2 T solenoid field.
- Reconstruction software importation and first channel simulations completed.
- Constructed 12 BCAL modules out of 48 as of July 2010. Construction and testing of the BCAL modules, both prototypes and production, is very labour intensive and the number of students employed and trained under the current five-year plan exceeds 24.

This detector development had also a significant technological impact for Physics and Medical Applications. The requirements of photo-sensor read out for the BCAL are very restrictive. They need to be compact and to be able to operate within the 2.2 T superconducting solenoidal field. Conventional Photo-multipliers (PM) of any type were not meeting the requirements. To answer that challenge the group initiated contacts with the emerging Si-based technology to pursue a larger area SiPM with a minimum of 1.26 cm² area. Considering that the largest SiPM sensors available at that time were 1 mm², the undertaking was very ambitious. Under two DOE R & D contracts totalling U.S.\$525,000, the first SiPM arrays were custom made and tested at the UofR and JLab. The technology has now matured to the point that large area SiPM-arrays have been selected for the BCAL read out. It is worth noting that the large area SiPM-arrays available in the market now, by SensL (Ireland) and Hamamatsu (Japan), is 1.26 cm² as was defined by the BCAL needs! SiPM-arrays have tremendous applications in Nuclear and Particle Physics (the CMS upgrade at CERN is going this route as is the KLOE upgrade at INFN/Frascati). It is, however, the medical field that is probably the biggest market for PET within MRI applications. Canadians at GlueX initiated this technology demand on industry, and played a vital role in testing and providing feedback to R & D companies and finally the SiPM production industry.

The construction of the BCAL will be completed by the summer of 2012, at the end of the first year of the new five-year plan. The BCAL is the first detector scheduled for installation in Hall D, as GlueX enters the detector integration stage. This means that the presence of Canadian GlueX members at JLab will increase sharply, moving from the end of the BCAL construction at the UofR, to a much larger effort on software development for the first test-beam and engineering runs at JLab. Throughout 2013-2015, there will be cosmic ray and beam tests and engineering runs, and perhaps the first physics runs in 2014. Even though some physics results may be possible from the 2014 running period, the physics phase will start in earnest in 2015 and GlueX will run in dedicated mode for the first five years or so. The Canadian effort will continue playing a leading role in the analysis and eventual publication of the results. This is also a period that graduate students will benefit greatly from the varied research experiences offered by the experiment.

In this planning the limiting factor will be financial, because by then all the funding from U.S. sources will be exhausted. Support for graduate students, the research scientist and

one post doctoral fellow plus travel and extended stay at JLab will require a 10-20% increase over the current the current 3-year average NSERC funding of \$210,000/year if we are to capitalize on the leading position of Canadians within GlueX and the opportunities for leading the analysis efforts on a “discovery experiment”.

3.4.3 The QCD Transition Regime

Canadians made particular contributions to electron scattering studies aimed at measuring the electromagnetic form factors and spin structure functions of the proton. In elastic scattering, where the space-like form factors are measured, quark effects in the hadronic system do not readily manifest themselves. However, this subject is of crucial importance, because it is where the most detailed tests of our understanding of QCD can be obtained.

Hall C at JLab will have the only magnetic spectrometer, the Super High Momentum Spectrometer (SHMS), able to detect charged particles with momenta approaching that of the highest electron beam. Together with its companion, the HMS, this will make Hall C the only facility in the world capable of studying (deep) exclusive reactions up to $Q^2 \approx 15\text{GeV}^2$, with appropriate high luminosity. By extension, only Hall C will be able to exploit fully semi-exclusive reactions in the critical region where the electroproduced hadron carries almost all of the energy transfer. The SHMS+HMS spectrometers, in combination with the large luminosity, will enable the measurement of the smallest cross sections and greatly facilitate studies in the transition from hadronic to quark-gluon degrees of freedom. Three experiments forming a key component of the initial SHMS+HMS scientific program are led by Canadians:

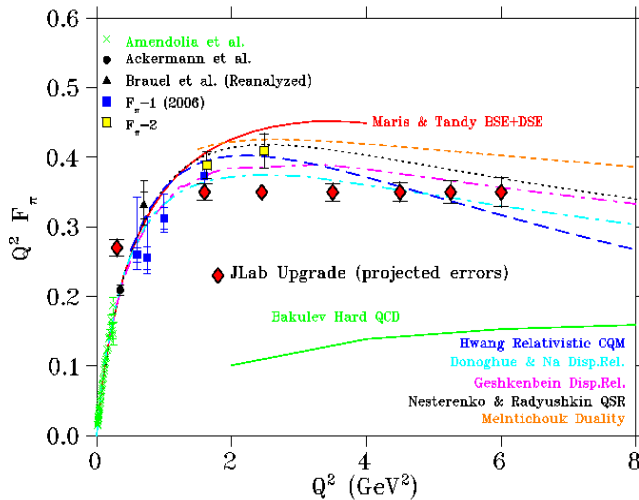

Fig. 3.4.2. Projected data for measurements of the pion electromagnetic form factor, as a function of Q^2 . Also shown are results for a variety of calculations modeling QCD in the transition region.

- The experiment E12-06-101 studies the Charged Pion Form Factor to High Q^2 . Huber, one of the two spokespersons has been a driving force on measurements of the pion form factor (F_π), with a series of successful experiments at increasing values of Q^2 . The experiments have gathered about 400 citations to date because of the importance of this observable to our understanding of QCD over short and

longer distance scales. Because the pion has a relatively simple $q\bar{q}$ valence structure, it is an observable that all QCD-based calculations use as a first test case (the “positronium atom” of QCD). Although the pion form factor is rigorously calculable in perturbative QCD (pQCD), it is not known where the experimental value will reflect the onset of pQCD. The actual behaviour of F_π as a function of Q^2 , as QCD transitions smoothly from the non-perturbative (long-distance scale) confinement regime to the perturbative regime, is an important test of our understanding of QCD in bound hadron systems (see Fig. 3.4.2). Since QCD calculations cannot yet be performed rigorously in the confinement regime, the experimental data from Jefferson Lab play a vital role in validating the theoretical approaches employed. There is no other existing or planned facility worldwide at which these measurements can be pursued. Based on the successful experiments and the successful analyses that followed, the extension of the measurements to higher Q^2 was endorsed by the 2002 U.S. Nuclear Science Advisory Committee (NSAC) as an example of the exciting physics enabled by the 12 GeV Upgrade: “Another important issue in the physics of confinement is understanding the transition of the behaviour of QCD from long distance scales (low Q^2) to short distance scales (high Q^2). The pion is one of the simplest QCD systems available for study, and the measurement of its elastic form factor is the best hope for seeing this transition experimentally.” The measurement was reviewed by both JLab PAC 30 and PAC 36, and it has been awarded the highest possible scientific priority and formally allocated the full beam-time requested.

- Huber is also one of the spokespersons of experiment E12-07-105 that will perform a scaling study of the L-T separated pion electroproduction cross section at 11 GeV. This is a related 12 GeV experiment whose purpose is to measure the Q^2 dependence of the longitudinal and transverse $p(e, e'\pi^+)n$ cross sections at constant $x=0.31, 0.40$ and 0.50 . The longitudinal cross sections will provide a test of whether the data have, or are evolving towards the $1/Q^6$ scaling prediction for hard exclusive processes. Similarly, the transverse cross sections are expected to scale as $1/Q^8$. The extraction of Generalized Parton Distributions (GPDs) from hard exclusive reactions relies on the factorization of the amplitude into hard and soft processes. If factorization holds, the longitudinal cross section should be dominant and the separated cross sections should scale according to the $1/Q^n$ predictions of pQCD. JLab PAC 32 concurred with our assessment, stating “A detailed study to determine whether or not meson electroproduction can provide information on GPDs is important.”
- Finally Canada plays also a leading role in experiment E12-09-011 that has for objectives to study of the L-T Separated Kaon Electroproduction Cross Section from 5-11 GeV. The $p(e, e'K^+)\Lambda$ and $p(e, e'K^+)\Sigma^0$ reactions are important tools in our study of hadron structure. The flavor degree of freedom introduced with the addition of the strange quark provides important information for QCD model building, as well as for our improved understanding of the basic coupling constants needed in nucleon-meson and quark models. The 12 GeV Upgrade and the SHMS will allow these studies to be performed for the first time. Since there

is no single criterion for the applicability of factorization, tests of every necessary condition are needed. A direct comparison of the scaling properties of hard exclusive K^+ and π^+ electroproduction would thus provide another important tool for the study of the onset of factorization in the transition from the hadronic to partonic degrees of freedom in exclusive processes. Measurements of the longitudinal cross section at low momentum transfer will also determine whether the K^+ electric form factor can be inferred from these data. If the studies are favorable, it will lead to the first ever extraction of the K^+ form factor above $Q^2 = 0.35 \text{ GeV}^2$. These measurements have been approved by JLab PAC 34 and will receive their scientific rating in early 2011.

These three experiments are among those to be performed in Hall C using the new Super High Momentum Spectrometer (SHMS). The contributions of Huber and collaborators to the Hall C program have been acknowledged by NSERC through an RTI grant to construct and instrument the Heavy Gas Čerenkov counter to be installed on the SHMS. The Heavy Gas Čerenkov detector is the only detector responsible for charged pion identification in the SHMS. As such, it is a critical component of the Canadian-led portion of the SHMS scientific program. This detector is also an appropriate Canadian contribution to the SHMS because it makes use of Regina expertise built up in earlier detector projects, such as the Aerogel Čerenkov detector constructed for JLab Hall A, and the Gas Čerenkov detector constructed for TAGX. The Heavy Gas Čerenkov was funded by NSERC in the 2010 competition, for \$80k in the first instalment and \$45k to follow in 2011.

These experiments make an excellent HQP training ground. Intermediate energy experiments represent a compromise between the large collaborations of high energy physics and the small groups of low energy nuclear physics. Students will have access to the most modern techniques, such as state-of-the-art beam polarimetry and data acquisition systems, and yet is small enough that students and PDFs can be exposed to many aspects of the experiment. This will allow them to become well-rounded scientists, capable of critical thinking, leadership, and teamwork in their future careers. They will develop expertise in nuclear electronics, statistical analysis, experiment design, data acquisition and analysis, and computational skills required for detector simulations. The construction and commissioning of the Heavy Gas Čerenkov detector is an ideal student project; e.g. NSERC USRA students were hired in the summers of 2009 and 2010 to finalize detector design and optics simulations. Upcoming student projects will include optical quality tests of the parabolic mirrors (iris tests and coarse Ronchi grid tests), cosmic ray testing of the detector, and further simulations.

At present, the Hall C efforts are divided nearly equally between the analysis of data from the “6 GeV era” and preparations for the “12 GeV era”. The Heavy Gas Čerenkov is expected to be delivered to JLab in the spring of 2013, where it will be assembled, tested, and installed on the SHMS. The detector stack and acquisition system will then be fully tested with cosmic rays, in preparation for the first beam to Hall C scheduled for August, 2014. In order to ensure our experiments can meet their precision goals in a very high

luminosity environment, the commissioning and calibration of the SHMS magnets and detectors will require a careful, dedicated effort.

Over the past 5 years, the Canadian Hall C effort has required about \$65,000/yr in funding. The \$38,000/yr provided by NSERC Discovery Grants has not been sufficient to support Canadian group's prominent role in a highly rated scientific program, and so JLab generously provided extra operating funds. This additional funding has now been exhausted. With the recent funding of the Heavy Gas Čerenkov RTI grant (\$125,000), it is hoped that the required operating funds will now be entirely provided by NSERC. Once the Canadian experimental efforts at Mainz are completed, it is expected the annual Hall C operating request in support of two FTE faculty to be approximately \$150,000/yr.

3.4.4 The Nucleon Structure Studies at High Values of Momentum Transfer

The research program at Jefferson Lab's Hall A over the past decade has provided Canadian leadership in experiments aimed at elucidating details of the structure of light nuclei and the nucleon, as manifest at low to intermediate values of the four-momentum transfer squared (Q^2), and is now poised to make continuing contributions out to very high Q^2 . Over the past few years, there have been periods of Hall A running with relatively low beam energy (≈ 0.35 -1.0 GeV) that have allowed detailed polarization studies at low Q^2 – this is a region in which nucleon structure is dominated by the dynamical effects of its “pion cloud”, and in which light nuclei (e.g. deuterium) can be modeled with a nucleon/meson description of the nucleon-nucleon interactions. While the studies of the light nuclei are now completed – with the last such experiment led by Sarty (St. Mary's), the experiment *E05-103* “Low Energy Deuteron Photodisintegration” (spokespersons: Gilman, Sarty, Strauch) having run in 2006 – the last of JLab's “6 GeV era” running in 2011-2012 includes two more low- Q^2 nucleon structure experiments that will be co-led by Sarty: *E08-010*, and *E08-007*.

The experiment *E08-010* will perform a measurement of the $\Delta(1232)$ Coulomb quadrupole amplitude in the low momentum transfer region. This experiment is scheduled for 2011, and is designed to probe “non-spherical” (quadrupole) contributions to the $N \rightarrow \Delta$ transition down to the lowest-ever-measured values of Q^2 . This will capitalize on the experience gained by Sarty in a tour-de-force recoil-proton-polarization measurement in pion electroproduction measurement conducted earlier in Hall A, in which these quadrupole contributions were clearly isolated at intermediate Q^2 values (1 GeV^2) through separation of 14 independent response functions. This new very-low Q^2 experiment pushes the extraction of quadrupole amplitudes into a regime that is dominated by dynamical pion-cloud effects, which need to be better understood in order to make a clearer connection of these transition amplitudes to the predictions which are now forthcoming from Lattice QCD calculations.

The other scheduled experiment, *E08-007*, will provide a measurement of the Proton Elastic Form Factor Ratio at Low Q^2 . This experiment is also scheduled to complete running in early 2012, and will use the double-spin-asymmetry method to push

measurements for the ratio of the proton's elastic electric-to-magnetic form factors ($\mu_p G_E/G_M$) to the lowest- ever values of Q^2 (down to 0.01 GeV^2). Results from Hall A's measurements of this ratio over the past decade have led to the unexpected observation that the ratio (which had previously been assumed to be approximately equal to unity) shows a steady decrease below unity as a function of Q^2 – the decrease was initially seen to start at about 1 GeV^2 , but running of the first part of this E08-007 experiment in 2008 has shown this deviation to begin at even lower values, around 0.3 GeV^2 . Because of these observed deviations from dipole behavior in the form factors, there has been much renewed theoretical interest in the structure and “shape” of the nucleon. Further, beyond the intrinsic interest in nucleon structure, improved form factor measurements down to these unprecedented low Q^2 values also have implications in other areas: for example, determination of the proton Zemach radius, and for corrections needed to interpret parity-violating elastic scattering measurements.

Canada has been able to contribute to small detector development projects in Hall A over the past several years. This includes: a new design for improved lightguides in the Hall A High Resolution Spectrometers scintillator-timing planes, a modification to the beam-current monitoring system to allow more accurate current measurements down to lower currents, and a feasibility study into using a rotating coil magnetometer as a better compass for polarized target holding-field direction determination. Now, more ambitious detector contributions are ongoing, and are planned. Beyond this, and into the upcoming “12 GeV era” of JLab, Sarty is part of a team formed to develop a new detector facility in Hall A aimed at nucleon form factor measurements up to the highest values of Q^2 accessible at JLab. This new detector is called the Super BigBite Spectrometer (SBS), and a formal SBS Collaboration has been formed within Hall A. The SBS facility has undergone two rounds of favourable Technical Reviews (most recently in February 2010), and funding from the DOE has now started to be directed to university collaborators for construction of the various components. Canadian interest in the SBS project is driven by extending the proton electric-to-magnetic form factor measurements to very high Q^2 values – while the theoretical debate has erupted regarding physical interpretation of the newly discovered reduction below unity in the $\mu_p G_E/G_M$ ratio as a function of Q^2 . The various theoretical pictures diverge in predictions at high (as yet unmeasured) Q^2 .

Hall A experiments and development work provide an excellent environment for well-rounded training of both undergraduate and graduate students. In particular, some of the work on new detector development has been done by undergraduate students and graduate students in Applied Science.

During the early part of the period covers by this long range plan, focus will be on: completing the last of the “6 GeV era” low- Q^2 experiments discussed above (and analyzing the resulting data); completing the SCI-FI tracking detector development work, and, embarking on the segmented hodoscope BigBite spectrometer detector upgrade project. Beyond the next 5 years, it is planned to become increasingly involved in the 12 GeV program of the upgraded JLab. As briefly mentioned above, Sarty's interests related to the 12 GeV upgrade revolve around exploration of form-factors and resonance

transition form-factors at increasingly high Q^2 , in search of a clear onset of the transition region (this complements Huber's interests at 12 GeV), and also increased involvement with experiments probing Generalized Parton Distributions.

This effort, lead by Sarty, has been funded in the range of \$35,000-\$42,000 per year (with lower levels associated with diverting some research time/effort into the MAMI program described below). With 'status quo' funding, efforts could be maintained but very little left for undergraduate training. The new detector development upgrade project could not be pursued without a modest increase in funding. Some increased funding would allow significant contributions to the outlined Hall A program (particularly with respect to this and other detector upgrades), and to other 12 GeV upgrade plans.

3.4.5 Studies of QCD in the Non-Perturbative Region with Real Photons at MAMI

With the long beam-time commitment JLab has made to complete the "Qweak" experiment, along with the scheduled construction shutdown associated with the 12 GeV Upgrade, the other parts of the JLab program will be severely curtailed during the 2009–2014 time period. This has provided a window of opportunity for Canadian research efforts to be directed toward the newly-upgraded Mainz facility. NSERC Project Grant funding has allowed to significantly expand Canadian contribution and impact to the A2 Collaboration at the Mainz Microtron (MAMI) laboratory. Canadian contributions to MAMI programs are not new. Hornidge (Mount Allison) has been actively leading projects within the A2 group at MAMI for many years. It is expected that this collaboration will extend to the middle of this decade.

The recently completed upgrades at the Mainz laboratory include a new accelerator microtron (high-quality, high-flux continuous-wave 1.5-GeV electron beam providing a beam of polarized photons), a refurbished near- 4π CB-TAPS detector system, and a frozen-spin polarized proton target. These have allowed unique access to high-precision measurements of nucleon structure. Obtaining these new, precise nucleon-structure data is the aim of each of the experiments that have significant Canadian contributions. Hornidge is one of the spokesperson of each of these important experiments.

The flagship experiment (E-A2-11/09) of the Canadian efforts is the measurement of the spin polarizabilities of the proton in the energy range accessible at MAMI. Nucleon polarizabilities are fundamental structure observables like the charge and mass, but are related to the nucleon's internal dynamics—making them ideally suited for constraining/testing QCD-based models of nucleon structure. Although the two scalar (spin-independent) polarizabilities, α_{E1} and β_{M1} , are well understood, very few experiments have attempted to extract the spin polarizabilities – which can be written as γ_{E1E1} , γ_{M1M1} , γ_{M1E2} , and γ_{E1M2} – and none have managed to separate all four. The two "known" combinations of the polarizabilities,

$$\begin{aligned}\gamma_0 &= -\gamma_{E1E1} - \gamma_{M1M1} - \gamma_{E1M2} - \gamma_{M1E2} \\ \gamma_\pi &= -\gamma_{E1E1} + \gamma_{M1M1} - \gamma_{E1M2} + \gamma_{M1E2}\end{aligned}$$

have errors on the order of 10% and 25%, respectively. Unlike the scalar polarizabilities, these higher order polarizabilities can be thought of as parametrizing the “stiffness” of the nucleon spin against electromagnetically induced deformations relative to the nucleon spin axis. They have generated considerable theoretical interest in recent years. In order to extract all four of the spin polarizabilities, it will be necessary to conduct a series of double-polarization (beam and target) asymmetry measurements. Using these different experimental conditions should result in the extraction of γ_{EIEI} and γ_{MIMI} for the first time, with only a small systematic error due to the dependence on the theoretical models needed to extract the polarizabilities from the observed asymmetries.

The second experiment (E-A2-10/09) will utilize polarized beams and targets to provide a stringent test of our current understanding that the pion is a Nambu-Goldstone boson due to spontaneous chiral symmetry breaking in QCD. This experiment will test the detailed predictions of chiral perturbation theory and its energy region of convergence, in order to probe the spontaneous chiral symmetry breaking due to the mass difference of up and down quarks. The experiment will also acquire data on the time reversal odd transversely polarized target asymmetry, which is sensitive to the πN phase shifts, and provide information on neutral charge states in an energy region not accessible to conventional πN scattering experiments.

Finally experiment E-A2-8/05 will perform a measurement of the G-asymmetry in $\gamma p \rightarrow p\pi^0$ and $\gamma p \rightarrow n\pi^+$. Accessing details of nucleon resonance properties, such as electromagnetic excitation amplitudes, represents an important step toward constraining models of nucleon structure. However, such details are difficult to isolate, because the very short lifetimes of the resonances causes them to have a large energy width, creating a “mess” of overlapping states. It is expected that the next decade will show progress in the description of nucleon resonances using a less phenomenological approach, such as Lattice QCD. For example, the lowest positive-parity resonance ($P_{11}(1440)$ “Roper”) has an unclear model structure (either a “breathing mode” in spherically symmetric CQMs, or a q^3g “hybrid baryon” gluonic partner of the proton), but has now clearly been seen in lattice calculations as a “standard 3q state” as the first $T = 1/2$ excited state. Such developments in the theoretical descriptions need to be accompanied by new experiments with a more sensitive ability to unambiguously isolate the characteristics of nucleon resonances. This experiment will extract the double-polarization observable, G, which is obtained by flipping the orientation of the linear photon beam polarization between $+45^\circ$ and -45° with respect to the reaction plane, using a frozen-spin target. This measurement provides a needed window into disentangling the resonance excitation multipoles for the Roper resonance. The experiment will also measure, in parallel, the charged pion channel, $\vec{\gamma} \vec{p} \rightarrow n\pi^+$, to allow an isospin separation of the M_{1-} partial wave amplitude and an unambiguous isolation of the component associated with excitation of the $P_{11}(1440)$ Roper resonance.

In the case of the first two experiments on the proton spin polarizability and on the pion photoproduction the experimental measurements are expected to take approximately another two years to complete. The data analysis will continue for another few years, so

work on these experiments is expected to continue to nearly the end of the present five year plan. It is anticipated that the G-asymmetry experiment will run in 2012. This effort is currently supported by a \$140,000/year Project Grant Funding used to maintain one PDF on site, two graduate students at Dalhousie and Regina, and 3-5 honours/summer students. Looking past 2015, it is proposed to transition this effort exclusively back to JLab after the completion of the 12 GeV Upgrade.

3.4.6 A test of strong interactions induced modifications to the weak interaction: The NPDGamma experiment

The NPDGamma experiment measures the parity-violating (PV) directional gamma-ray asymmetry in the radiative capture of polarized cold neutrons on unpolarized protons in liquid hydrogen, in the reaction $n+p \rightarrow d+\gamma$. The asymmetry is a result of the strangeness-conserving ($\Delta S = 0$) hadronic weak interaction (HWI) between nucleons, which is a residual of the weak interaction between quarks, at low energy. Within the standard model of weak interactions, the charged current contribution to the $\Delta S = 0$ HWI is Cabibbo suppressed and the neutral current terms make contributions to all three isospin channels in the NN interaction ($\Delta I = 0,1,2$). Based on the current experimental and theoretical status it is not possible to determine the neutral-current, $\Delta I = 1$, part of the HWI. The goal of the NPDGamma experiment is to measure this part of the HWI, in a two-body system where nuclear-structure uncertainties are absent. A modern treatment of the HWI is based on effective field theory, which is the most general description, consistent with the symmetries and degrees of freedom of low energy quantum chromodynamics (QCD). In the context of QCD, the description of the HWI involves and provides a window on short-range correlations between quarks. To verify the effective field theory (EFT) approach measurements of PV asymmetries must be made in few nucleon systems, where few-body techniques provide exact nuclear wave functions. The aim of the EFT approach is to calculate the PV couplings from first principles, using lattice QCD.

The first phase of the experiment was performed on Flight Path 12 at the Los Alamos Neutron Science Center at Los Alamos National Laboratory (LANL) and was completed in 2007 with a result of $A_\gamma = (-1.2 \pm 2.1(\text{stat}) \pm 0.1(\text{sys})) \times 10^{-7}$. The first phase was a crucial test of systematic effects, to establish the capability of the experiment to reach the goal combined error of 1×10^{-8} .

The experiment is currently being installed on the FnPB (Fundamental Neutron Physics Beam Line), at the SNS (Spallation Neutron Source, Oak Ridge). The experiment beam line, cave and shielding has been completed and individual experiment components are ready for installation or are being currently installed. The University of Manitoba group (Gericke, Page et al), with support from TRIUMF electronics shops, supplied two new neutron beam monitors, needed to cover the larger beam cross-section at the FnPB. NPDGamma is expecting first beam for commissioning of the second phase, starting in January or 2011 and is expected to complete data taking in late 2012.

3.4.7 HOT AND DENSE QCD

There is a vibrant research program, both in theory and in experiment that seeks to investigate the bulk properties of QCD, far from its ground state ($T = 0$, equilibrium nuclear density). In short, this research effort aims to produce a quark-gluon plasma (QGP) – an interacting ensemble of the partonic constituents of the nucleon – and to quantitatively study its properties. A consequence of this research is the exploration of the QCD phase diagram, is shown in Fig. 3.4.3. In this context, the experiments performed at the CERN SPS since the late 80's have paved the way for a first decade of very successful RHIC (Relativistic Heavy Ion Collider, at Brookhaven National Laboratory) operation.

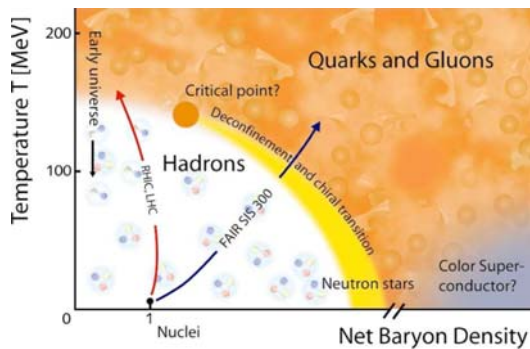

Fig. 3.4.3. The figure reflects our current understanding of the QCD phase diagram: It shows the different phases of strongly interacting matter in the temperature-baryon density plane. It also shows the regions accessible to different accelerator facilities. Canadian teams have made contributions to the high and low energy (temperature) regions of this diagram.

As RHIC continues, the LHC (Large Hadron Collider) will begin in the Fall of 2010 to perform measurements of relativistic nuclear collisions. Indeed the majority of LHC experiments (ALICE, ATLAS, and CMS) have been adapted to perform in the high-multiplicity environment germane to heavy ion collisions. All of those three large experiments have a heavy ion analysis contingent. The Canadian experimental effort is currently concentrated in ATLAS, mostly in the particle physics sector. Finally, Canada has a very active effort in high-energy nuclear theory.

A QGP – an interacting ensemble of quarks and gluons whose spacetime extent exceeds that associate with a nucleon – forms when temperature exceeds about two trillion degrees Kelvin (equivalently, $T \approx 200$ MeV). This extreme environment naturally existed at only about a microsecond after the Big Bang. The QGP created at RHIC, and also at LHC in the near future, therefore gives us a rare opportunity to test our theoretical ideas about the conditions of the early universe.

A very large spectrum of questions about the QGP and its characterization can be imagined. We limit ourselves to two broad classes: What are the equilibrium properties of the QGP? How does the QGP dynamically evolve in time? The answers lie in the use of penetrating probes of this fascinating new material.

3.4.8 Equilibrium properties of the QGP

Relativistic thermal field theory provides a well defined starting point of studying the equilibrium properties of QGP. The questions to answer here include determining the equation of state, the nature of excitations, the scattering rates, the correlations among quarks and gluons, and the fluctuations/dissipations. One systematic way to attack these questions is to consider extremely high temperatures at which asymptotic freedom makes the coupling constant small. Conceptually one should then be able to use Feynman diagrams and perturbative expansions to obtain thermodynamic quantities, correlations and fluctuations and scattering rates. However, actual calculations of these quantities are fraught with subtleties. The presence of thermal excitations in the system introduces additional divergences and in most cases, even the leading order calculation requires summing over an infinite set of Feynman diagrams. Going to the next-leading-order requires considerable efforts. However, this is an important endeavour, as for dissipation coefficients such as the viscosities and conductivities, this calculation strategy currently represents the state-of-the-art.

In Canada, the theoretical work in this field is largely conducted at McGill University. In recent years, the McGill group has lead the effort to calculate dissipative coefficients in hot QGP, with many of their results being the first complete leading order calculations of the transport coefficients. For thermodynamic quantities such as the equation of state, another way is available: One can pursue a numerical solution of thermal QCD. This is a truly non-perturbative way of analyzing strongly interacting systems at finite temperature. One of the issues being pursued actively in this area is the inclusion of finite baryon chemical potential. Many exciting consequences of a finite chemical potential such as the existence of a (possibly experimentally accessible) critical point are still largely unexplored.

3.4.9 The evolving QGP

A striking realization stemming from the theoretical analyses of the first generation of RHIC experiments has been that of the hydrodynamic behavior of the bulk of the hot and dense matter produced in heavy ion collisions. Indeed, the most compelling evidence of the QGP comes from the fact that the matter created in heavy ion collisions flows like an ideal fluid with an enormous energy density and pressure. On the theoretical side, an intriguing link between the string theory and the QGP has emerged (see next section), resulting in a possible explanation of why QGP is so surprisingly close to the ideal fluid. Given the paramount importance of QGP studies based on relativistic hydrodynamics, the fact that only a few groups in the world are currently capable of simulating the formation and the evolution of the Quark-Gluon Plasma (QGP) using realistic hydrodynamics is somewhat surprising. This situation is partly due to the complexity of the problem, and partly due to the need for large manpower and computing might.

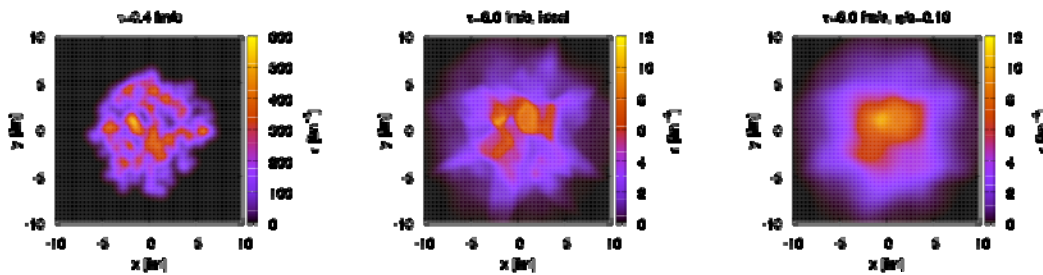

Fig. 3.4.4. A three-dimensional relativistic hydrodynamics simulation of a high-energy nuclear collision. The left panel shows the initial state energy density in the x-y plane, the middle panel shows the system after 6 fm/c with ideal hydrodynamics, and the right panel shows the system after 6 fm/c if the evolution is viscous (the shear viscosity to entropy density ratio is set to 0.16).

Recently, a concerted effort was made in the McGill group to produce the state of the art fully 3 dimensional viscous hydrodynamics code (Fig. 3.4.4). This already resulted in 2 publications and its full potential is actively being explored.

3.4.9.1 Hard and electromagnetic probes of the QGP

The initial stage of an ultrarelativistic heavy ion collision involves two energy scales. The part of the system that carries most of the beam energy (valence quarks) interacts scarcely but when they do, the collision produces hard partons (“QCD jets”) and hard photons (real and virtual), with their energy scale comparable to that of the beam. The abundant soft part of the system (“wee partons”) interacts strongly because the energy scale is much less than the beam energy. The soft parton interactions ultimately produce QGP which we wish to study. The initial properties of jets and hard photons, on the other hand, hardly changes from those of the well-studied hadron-hadron interactions. Therefore a particularly important means to explore QGP is the modification of the jet and photon properties. As these hard probes propagate inside the QGP, their properties undergo remarkable changes due to the extreme medium that surrounds them. Understanding how the medium changes the jet properties is an important question that needs to be answered through theoretical calculations and numerical simulations.

In both analytic calculations and numerical simulations, McGill group has been a world leader in this field in recent years. The first full leading order calculation of jet energy loss rate and the photon radiation rate in static QGP were performed by the members of the group. These were in turn used with a hydrodynamically evolving background, to describe and predict jet energy loss and hard photon production in RHIC experiments. Finally, for the first time, an event-by-event high pT simulation tool for heavy ion collisions was developed by the McGill group. Various hard probes including high energy photons and high energy dileptons are actively being investigated.

3.4.9.2 The QCD Phase diagram near normal nuclear matter density

Canada contributes also to the study of the QCD phase diagram close to normal density. Besides its fundamental aspects, this work is clearly relevant to nuclear structure and astrophysics. The experimental work lead by a group from Laval University which focuses on the study of reaction dynamics between heavy (and light/heavy) ions, at 10 – 15 MeV/A at ISAC-II and at 10 –75 A MeV at GANIL (Caen, France).

In addition to the above experimental program a small but important theoretical effort touches on this aspect of the QCD phase diagram. Subal DasGupta is studying the properties of dilute nuclear matter. His work suggests that from very general consideration dilute nuclear matter (at densities lower than half the normal density) has a first order phase transition. This work has to be extended to higher density to find if this phase transition is associated with a critical point, a challenging task within the present approach. The low density QCD phase diagram predicts the existence of hypernuclei, nuclei containing hyperons in addition to the usual protons and neutrons. The recent observation of antimatter hypernuclei by the STAR collaboration at RHIC provides a striking evidence that high energy heavy-ion collisions is a unique method to produce new exotic nuclei. A model has been developed by Gupta to estimate the production cross section of such nuclei in heavy-ion collisions. This model has up to now been motivated by future experiments at FAIR, but will be extended to RHIC energies.

3.4.10 SOLVING QCD NONPERTURBATIVELY

Since several of the phenomena associated with hadronic physics activities purposively span the energy region between the asymptotically free and confined limits of QCD, theoretical guidance and analysis in the confined sector can only come from nonperturbative techniques. The use of lattice QCD in finite temperature problems has already been alluded to, but manifest Canadian leadership exists in solving QCD at zero temperature on the lattice.

3.4.10.1 Lattice QCD at zero temperature

Theoretically, the way to solve QCD in this specific regime has been to discretize space-time and to formulate the theory on a discrete grid. Technically, the lattice is a discretization of space and (imaginary) time: the theory is solved numerically in a box. This is a numerical method that starts from first-principles QCD and has been extrapolating down in energy, towards the regime relevant for nuclear physics. Canadian groups have been active in lattice calculations of gauge theories (e.g. SFU, Laval, TRIUMF, York), and are responsible for important breakthroughs. A complementary effort in theory has been the development and furthering of perturbative techniques that incorporate the symmetries of QCD, like chiral perturbation theory and associated methods that seek to go past leading order (LO) evaluations. Until recently, lattice QCD had failed to achieve a level of precision for long-distance hadronic physics comparable to the many successful applications of perturbative continuum QCD to high-energy

processes. The main impediment had been the enormous computational cost of simulating quark vacuum polarization. For decades most lattice QCD studies had simply dropped sea quark effects entirely, working in the so-called “quenched approximation.” This situation has been revolutionized in the past five years, owing to a remarkable set of theoretical developments, based on effective-field theory techniques, which have led to a dramatic transformation of the physics reach and phenomenological impact of lattice QCD. In particular, there has been much progress in the development of “improved” lattice discretizations, which greatly reduce the computational cost of sea quarks, some of which also significantly reduce the size of cutoff effects on lattice grids of a given size. Unquenched simulations are now routinely done with the correct number of sea quarks, and at quark masses and lattice spacings that permit reliable chiral and continuum extrapolations to the physical point.

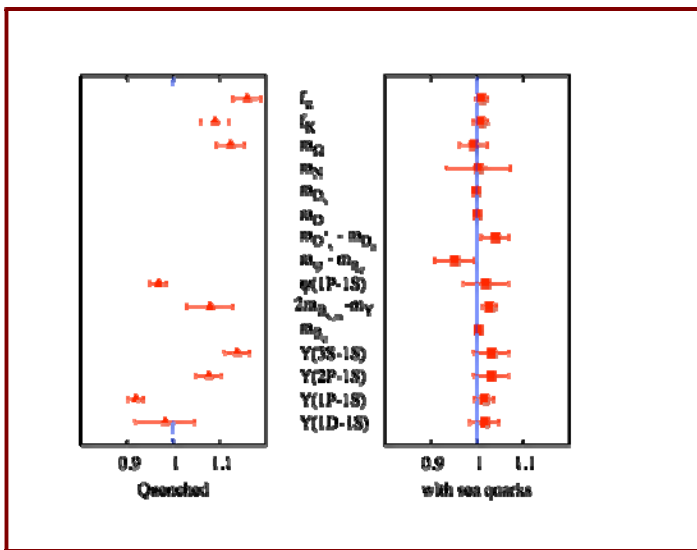

Fig. 3.4.5. Unquenched lattice QCD results divided by experiment for fifteen observables, using the improved staggered (“Asqtad”) lattice discretization for light quarks (right panel). All input parameters were fixed using other observables. Results from simulations without quark vacuum polarization are also shown for some quantities (left panel).

An illustration of the precision of state-of-the-art lattice QCD simulations is provided in Fig. 3.4.5, which compares experimental data for fifteen different quantities, with unquenched lattice QCD results generated by the HPQCD, MILC, and Fermilab Collaborations. An earlier version of this plot appeared in the major first publication by these groups in 2004. Recent work has yielded precision results for a wide variety of hadronic observables in agreement with experiment, with careful analysis of all systematic uncertainties. Lattice QCD simulations of hadronic matrix elements relevant to constraints on the quark mixing matrix have had decisive impact in interpreting results from the flavour factories.

Canadian contributions to the above work have been of particular importance in the precision determinations of fundamental parameters of the standard model, including of the strong coupling, the light quark masses, and of the charm quark mass, as well as in the development of a highly-improved lattice discretization for charm quarks. Canadian work in Lattice QCD has generated many other high-impact studies, including of the spectra of charmed and bottom baryons, systematic analyses of an important new formalism for light fermions, and the development of an algorithm for the simulation of a

state-of-the art fermionic discretization, which has recently been adopted by the MILC Collaboration, in a major new effort to generate a large ensemble of unquenched configurations.

3.4.10.1.1 *String theory techniques*

In recent years the theoretical study of strongly interacting systems has benefited from techniques germane to string theory. These stem from the celebrated AdS/CFT correspondence, which postulates a duality between a gravity theory formulated in one space and a field theory formulated on the conformal boundary of this space. In short, the AdS/CFT correspondence enables a strong coupling field theory calculation to be mapped onto a perturbative gravity problem, solvable analytically. A great deal of effort is currently being devoted to devise a gravity dual to QCD. On a related thread, string theory techniques have provided seminal insight into the small shear viscosity coefficient that stem from current theoretical analyses of RHIC nuclear collision data. The Canadian presence in the community pursuing the related aspects of theoretical physics alluded to here is considerable.

3.4.11 SUMMARY

The researchers involved in the program described in this brief have a diverse program of research in hadronic/QCD physics which is unique in the country. Each have undertaken key responsibilities in their respective collaborations and have made significant impacts with relatively modest NSERC funding, as well as with crucial financial support from facilities, JLab in particular. With respect to the long-term aim of QCD physics, to better understand the transition from meson-nucleon effective degrees of freedom at long distance scales, to quark-gluon degrees of freedom at short distance scales, the 12 GeV upgrade of Jefferson Lab is vital to the field. Should the SAP envelope increase substantially over the next 10 years, these new funds could allow experimental Canadian researchers to make key scientific contributions at this upgraded facility, and would allow theorists to continue a vigorous and diversified research agenda.

4 Demographics, Facilities and Dynamics

At several places in this section, specific recommendations, suggestions and observations are made that are of a more specific nature than the general suggestions given in the executive summary. We have identified these items by underlining them for the convenience of the reader.

4.1 *Nuclear Physics Theory overview*

A strong theory program is critical to the success of experimental efforts. Experimental progress and theoretical progress in nuclear physics go hand in hand. Theorists help motivate new experiments and interpret experimental results, while new experimental

data, enhanced capabilities, and increased precision in turn motivates theorists to refine existing theoretical approaches and to introduce new ones.

4.1.1 Introduction

Canadian nuclear theorists have made significant contributions to our understanding of all aspects of subatomic physics. In Canada there are about 20 theorists working in topical areas of nuclear physics covered by this report. This includes nuclear structure and nuclear reaction studies at low and intermediate energies, hadronic structure, fundamental symmetries in a hadronic environment, lattice QCD, and QCD under conditions of high density and/or temperature. The interests of nuclear theorists also overlap with other areas of many-body physics, including atomic (e.g. recent work on cold atoms), molecular, and condensed matter physics (e.g. renormalization Group methods), and chemistry (e.g. density functional theory).

Unlike experimental physicists, theorists are generally not part of large and long-term collaborations. Although few theorists work alone, they typically collaborate in small groups on particular projects. The typical time scales for these projects are shorter than experimental projects. Long-range planning therefore plays less of a role in theory than it does in experiment. It is advantageous for theorists to have flexibility to pursue new ideas or new initiatives on a short time-scale. An example is the tremendous growth in nuclear structure studies over past 5 years using renormalization group and density functional techniques borrowed from other areas of many-body physics, which is playing an important role in shaping the experimental program at ISAC.

Theorists are generally supported by NSERC Individual Discovery Grants. The theory program in Canada has benefited from the increased funding for theory arising from the 2001 report. Funds are used mostly for salaries to support HQP (about 70% of average expenditures). Many researchers in Canada are in small, often remote or isolated institutions but still manage to make noteworthy contributions. An example is the activity of newly appointed theorists Aleksejevs (Memorial University) and Barkanova (Acadian University) who have made theoretical contributions to the efforts related to the G0, Qweak and MOLLER experiments. Theory groups are small, and many institutions only have one or two nuclear theorists. Collaborations tend to be international rather than national. Theorists play an important role in teaching, and tend to attract excellent graduate students.

4.1.2 Recent highlights

In this section advances in selected areas of nuclear theory are highlighted. A detailed discussion is found in the appropriate other sections of this report, together with related experimental advances.

4.1.2.1 Nuclear structure and nuclear astrophysics

We have entered an exciting era in nuclear structure physics, in which substantial progress can be expected on many fundamental problems. This is due to advances on many fronts, including the development of effective field theory and the renormalization group in nuclear physics, advances in ab-initio methods for nuclear structure, the effort to develop a universal density functional from microscopic interactions, and the application of large-scale computing resources.

It is now realized that the strong repulsive short-range interaction that has plagued nuclear physics theory since its inception can be tamed by renormalization techniques to generate an interaction appropriate for the energy scale of low-energy nuclear physics. New many-body techniques, the no-core shell model or coupled cluster calculations, are now using the improved interactions to calculate nuclear properties without the introduction of additional free parameters.

The theory group at TRIUMF in particular has played an important role in these contributions, with applications ranging from halo nuclei to low-density matter and reactions under astrophysical conditions. Recent progress is described in more detail in section 3.1.7. TRIUMF has made a significant investment in nuclear structure theory in support of the ISAC program. This program has a strong connection to the many-body physics of atomic and condensed matter systems, and to nuclear astrophysics.

4.1.2.2 Fundamental symmetries

High precision measurements can serve to discover new physics when combined with detailed studies of theoretical predictions and theoretical analysis. This is a highly active area in Canada, characterized by close collaboration between theorists and experimentalists. Of particular note is the 2006 Bonner prize to Towner and Hardy for their detailed analysis of superallowed β -decay to explore the unitarity of the CKM matrix as a test of the Standard Model.

Parity-violating electron scattering and atomic parity-violation experiments have been undertaken to understand the weak neutral current interaction. Theory plays an important role in interpreting the results of these experiments, in particular if one wants to look for physics beyond the Standard Model. Canadian theorists have been involved in the calculation of radiative corrections that are necessary to extract meaningful results at a high level of precision. Of particular note are significant two-boson exchange (γZ , ZZ , and WW) contributions, which have associated hadronic uncertainties. However the use of dispersion relations invoking experimental data on cross sections measured at HERA and elsewhere can be used to significantly reduce these uncertainties.

4.1.2.3 QCD and hadron structure

The charge and magnetization distribution of protons and neutrons are studied by electron scattering experiments at Jefferson Lab (section 3.4.4). Canadian-led efforts using polarized beams and targets have resulted in a new level of high precision measurements of neutron and proton electric and magnetic form factors. The results of these experiments stand in stark contrast to the existing measurements using unpolarized electrons. The discrepancy is now thought to arise from subtle two-photon exchange contributions, first identified by Blunden et al, which affect the interpretation of the unpolarized measurements. Future experiments which aim to directly measure the two-photon contributions are planned, and improved theoretical calculations accounting for the hadronic uncertainty are underway.

There is a significant effort in the physics of the quark-gluon plasma (sections 3.4.7-3.4.9), largely by the group at McGill. These researchers have made outstanding contributions to the understanding of relativistic heavy ion physics. In particular, there have been advances in both analytic and numerical simulation of QCD jets and hard photons, and in understanding how the medium changes jet properties as they propagate through the quark-gluon plasma. This group has also contributed to the study of the QCD phase diagram near normal nuclear matter densities.

During the past five years, calculations with lattice QCD have evolved to the stage where precision of a few percent is within reach. At this level of precision, full dynamical simulations are required, and light (up/down) quark masses have to be sufficiently small so that a meaningful extrapolation (aided by chiral effective theory) can be made to the physical mass region. There is a strong Canadian presence in this field (TRIUMF, SFU, York), described in more detail in section 3.4.10.

4.1.3 Issues and Outlook

There are a number of challenges facing the nuclear theory community. The issue of renewal raised in the 2006 report is still of some concern:

“A significant problem looms for the nuclear theory community. Many of the outstanding nuclear theorists in Canada have retired, or are near retirement. While they will be active for many years to come, renewal over the next 10 years is critical to the continued efforts in the field. The level of renewal of nuclear theory in Canada over the past 10 years is a source of concern.”

There are excellent individuals and small groups in Canada, but some clear gaps in key areas of experimental interest (e.g. reaction theory, nuclear astrophysics) are apparent. There is currently an urgent demand for increased theoretical activity in nuclear structure, nuclear reactions and nuclear astrophysics especially to support the rapidly developing experimental capabilities at the ISAC facility. As identified in the 2006 report, TRIUMF could fund ISAC theory positions at universities analogous to the JLab/RIKEN positions in the U.S. Even a modest number would have a tremendous impact.

As identified in the previous LRP , Canadian theorists face challenges because they normally operate as small groups in a geographical large country. Some attempts have been made to find a mechanism for interactive opportunities and for opportunities to enhance the training of graduate students. Beyond continued support for a healthy base program, the continued funding of workshops, conferences, summer schools, and long-term visitor programs is important. Such activities allow theorists to keep abreast of developments in the field, help to keep isolated researchers involved in research, and provide training for students and post-doctoral fellows. In the last 2 years, 2 workshops have received support from the CINP. This is a good beginning and could be enhanced and made more substantial.

Recent successes in areas such as lattice QCD, quark-gluon plasma hydrodynamics, and large-scale nuclear structure calculations (e.g. no-core shell model) have come from the application of large-scale computing to problems in nuclear theory. We expect the demand for computing resources to continue to increase and therefore strongly endorse initiatives to provide adequate resources for advanced scientific computing.

4.2 Facilities

The description of the scientific activities of the Canadian nuclear physics community described in the sections above identifies several facilities that are used to carry out this work. While the ISAC facility at TRIUMF emerges clearly as the most important resource for our community, many other international locations also play critical roles. The sections below give a brief description of the nature and importance of some of these facilities. The treatment may not be exhaustive but it serves to illustrate how the unique combination of the skills and resources of the Canadian researcher coupled with the specific capabilities of each facility makes it possible to leverage our resources to make important contributions to the field beyond what would be possible if we acted alone.

4.2.1 Canadian facilities and infrastructure

4.2.1.1 TRIUMF

An overwhelming majority of the efforts described in foregoing sections of this brief identify the facilities at the TRIUMF laboratory as a major resource for their past, present and planned work. This facility provides a home for the work of a great majority of investigators from Canada. Their work in the next 5 years and beyond will exploit the capabilities of the ISAC I and ISAC II accelerators and the comprehensive set of state-of-the-art spectrometers and detectors that have been installed there. TRIUMF is currently the premier, operating, radioactive beam facility in the world. The unique facilities at TRIUMF have attracted 122 scientists from Canada and 427 scientists from 21 other countries. New facilities are either planned or under construction in Germany, USA, Japan, China, Korea and other places. In order to maintain its position, TRIUMF will require the continued development of new high quality beams of radioactive ions.

- Support for the experiments in nuclear structure, nuclear astrophysics, fundamental symmetries and other programs at ISAC I and ISAC II is crucial for Canada to reap the benefits within reach of these excellent facilities and should be a top priority for Canadian Nuclear Physics in the next 5 years and beyond.
- TRIUMF should be encouraged to give high priority to the development of reliably delivered, high quality, radioactive beams necessary for the current and planned experimental programs at ISAC. The development of a second proton beamline and the new ARIEL system for radioactive beams need to be pursued vigorously if TRIUMF is to maintain its leading position among radioactive beam facilities world wide over the next decade.
- The funding levels for the next 5 years for operating TRIUMF were recently announced. It is very positive that in these times of economic duress, when many government programs have experienced cuts, that the level of funding has been set at roughly the same level as the last 5 years. Under these conditions it is unavoidable that there will have to be compromises in how TRIUMF allocates these resources between the programs in nuclear physics, particle physics and other initiatives. We hope that resources will be allocated in a manner that allows a timely exploitation of the nuclear physics facilities at TRIUMF.

In addition to the facilities that support the on-site experimental efforts at TRIUMF, the facility also plays a critical role in supporting the work of particle and nuclear physicists at facilities elsewhere. Such infrastructure support has greatly benefitted the work of Canadian nuclear physicists at JLab (e.g.: the G0, Qweak etc.). The newer initiatives such as MOLLER and TREK will undoubtedly continue to need similar support. Typically, Canadian researchers use TRIUMF support in the design, construction and testing of large detectors (in the TRIUMF meson hall) and spectrometers and the associated electronics. These efforts have greatly increased the capability of Canadian researchers to make a significant impact in large international collaborations and attract funds from outside the Canadian system. We view TRIUMF's role in providing this supporting infrastructure as highly valuable.

The theory group at TRIUMF has traditionally played an important role in Canadian efforts in nuclear and particle physics. A continuing Canadian problem is the small numbers of such theorists at Canadian universities and the geographical isolation that results. An effort by a national resource, like TRIUMF or the Perimeter Institute, to provide opportunities for nuclear theorists across the country to form collaborations and connections (especially to the on-going experimental efforts) could very useful.

4.2.1.2 SNOLAB

The SNOLAB facility is the second large particle and nuclear physics facility in Canada. A major CFI grant was used to build this facility which is now very close to completion and the first experiments are now beginning to be installed in the facility. At present there is no strong overlap between the work described in this brief and the planned work at

SNOLAB which could more easily be characterized as addressing important questions in particle physics. One should note however that the work on double beta decay has traditional had strong overlaps with nuclear physics and that researchers using the CPT mass spectrometer at ANL and TITAN at TRIUMF have made contributions to this field. It is important for the field of subatomic physics in Canada that issues with the continued funding for operation of this facility be resolved. Such issues are discussed in the other briefs that will be submitted to the NSERC SAPES LRP committee.

4.2.2 International Facilities and Infrastructure

4.2.2.1 International facilities and infrastructure – USA

4.2.2.1.1 Jefferson Lab (CEBAF)

The Jefferson Laboratory (JLab) currently provides 6 GeV electron beams of unprecedented quality and stability and is the world's pre-eminent facility in electroweak physics. Canadian use of this facility spans a 20 year period and has grown. At present this Canadian contingent is the largest concentration of nuclear physics effort outside the country and involves 13 NSERC eligible personnel from 6 institutions distributed across 5 provinces in Canada. The laboratory is undertaking a major upgrade in the next year that will double the energy of the electron beam to 12 GeV. First beams from the upgraded facility are expected in 2013 and full experimental capabilities will be reached by 2015. Current Canadian experimental efforts are expected to complete their data taking phase and continue with the analysis and publication phases of their experiment during the shutdown. The development of new experiments like MOLLER and detectors for GlueX will be completed during this period as well. Details of the programs at JLab are covered in detail in earlier sections of this report.

Canadian contributions have had a very high impact at JLab and there will be a continued strong Canadian presence at JLab for the long term. This work is a unique and important contribution to nuclear physics and should be supported with high priority.

4.2.2.1.2 Argonne National Laboratory (ANL) - USA

The Argonne Tandem Linear Accelerator System (ATLAS) is a heavy ion accelerator that is coupled to a suite of gamma-ray and magnetic spectrometers. Since 2001, the Canadian Penning Trap (CPT) mass spectrometer has been operational at this facility. The CPT group developed a technique that allows unstable nuclei produced in the fission of ^{252}Cf and to captured, in-flight, in a precision Penning trap. This allows the study of a diverse range of short-lived nuclides independent of their volatility or chemical properties. The CARIBU upgrade at the ATLAS facility will exploit this technique and use a ~ 1 Ci ^{252}Cf source to produce bunched ion beams of neutron rich nuclei with unprecedented purity and beam quality. The CPT has been moved to a new beamline that will allow it to directly access the neutron rich nuclei from CARIBU for measurements. It is also planned to inject and accelerate the CARIBU ion beam using the existing ATLAS accelerator and use these very neutron rich projectiles for nuclear structure and

astrophysics measurements. The γ -ray spectroscopy group, involving physicists from Guelph, Saint Mary's, Simon Fraser, McMaster, and TRIUMF also perform experiments using the GAMMASPHERE spectrometer at the ATLAS facility to complement their radioactive-beams program. The radioactive beams from CARIBU will enhance the opportunities available to several Canadian researchers.

4.2.2.1.3 HIGS

There has been a considerable transfer of Canadian infrastructure from the former Saskatchewan Accelerator Laboratory to the High Intensity Gamma Source (HIGS) at Triangle Universities Nuclear Laboratory (TUNL) in North Carolina. In about 5 years time it is expected that photon energies above the pion production threshold will be possible at HIGS. This, coupled with the unique polarized photons available at HIGS will open up exciting new avenues of research. A single Canadian principal investigator is involved in experiments at this facility.

4.2.2.2 International facilities and infrastructure – Europe

4.2.2.2.1 CERN

The ALPHA-Canada collaboration has demonstrated the production of anti-hydrogen atoms and is working on a technique to trap antimatter. It includes members from both the nuclear and particle physics communities, and draws upon Canadian expertise in ion and atom trap physics and spectroscopy. They have leading scientific and technical impact within their collaboration.

4.2.2.2.2 Mainz (MAMI)

The Mainz Microtron (MAMI) in Germany has been recently upgraded to deliver a 1.5 GeV electron beam. Along with a polarized photon beam and new frozen-spin target, this facility has started a new series of experiments of relevance to QCD physics starting in 2006. Canadian researchers Hornidge, Huber and Sarty are involved in experiments at this facility. Their efforts here are complementary to their continuing and planned work at JLab.

4.2.2.3 International facilities and infrastructure – Japan

4.2.2.3.1 KEK and J-PARC

A Canadian group representing 4 institutions has been involved in KEK PS-E246, a study of time reversal symmetry in the charged kaon sector. This facility will deliver kaon beams of significantly higher flux and quality, offering an order of magnitude improvement in T-violation sensitivity. We note that the T2K neutrino oscillation experiment will also utilize this facility.

4.3 Education and Demographics

In addition to the research outlined in the previous chapters, the nuclear science community plays a vital role in training highly qualified personnel (HQP). Training the next generation of scientists is essential for building and running the new facilities, perform experiments, interpret the data and the new results, and generate new ideas potentially responsible for discoveries and technologies that will have an impact on our society in future. Moreover, nuclear scientists help to promote science in general and nuclear science in particular to the large public. Applications of nuclear science have provided great benefits to society. Example includes medicine through isotope production, the design of radiation detectors and the technology associated with mass spectrometers; and play a significant role in addressing societal demands on energy production and pollution reduction through development of new nuclear power plants, to just name a few essential contributions.

As a part of the SAP Long Range Plan Brief writing requested by NSERC, the Canadian Institute of Nuclear Physics (CINP) organized a survey to determine the dynamics and the demographics of the nuclear science community in respect to education, outreach, and new personnel in the period of 2005-2009.

All university physics and, occasionally, chemistry departments supported by grants from GSC19 in the last five years, and TRIUMF took part in the survey. An active faculty is considered a faculty member that is engaged in an ongoing research program, either in a group or on its own, and can include emeritus professors. Undergraduate and graduate students considered are either NSERC or otherwise funded.

Forty one faculty members from 15 departments have submitted relevant information on HQP training requested by CINP. Not all departments responded, and in some cases it was not clear that the responses were comprehensive.

Year	Undergraduate Students	Graduate Students	Postdoctoral Fellows	New Faculty Hires
2005	42	77	30	0
2006	40	82	43	0
2007	45	85	36	3
2008	48	89	40	0
2009	58	88	48	3
2010	47	80	49	2

Table 4.3.1. The number of undergraduate students, graduate students, post doctoral fellows, and new faculty members, who were or are involved in nuclear science research for the years 2005 to 2010. The data for 2010 only reflects the data accumulated until September 1, 2010.

We note that in 2005-2010 eight new faculty members were hired at TRIUMF and Simon Fraser University. Compared to the previous period of 2001-2005, the number of new

faculty decreased from 19.5 to only 8. Nevertheless, it is expected that the new faculty hired in the last two years 2009-2010 will contribute to an increase of HQP in the next years. Partial results have been obtained for 2010 as more students and postdoctoral fellows can potentially join after the end of the survey that is August 2010.

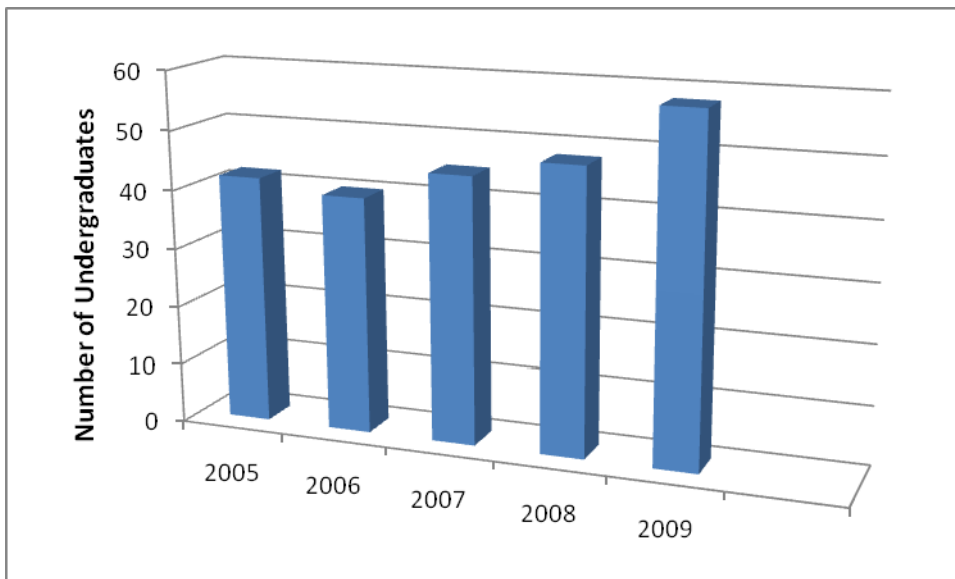

Fig. 4.3.1. Number of nuclear physics undergraduate students at Canadian physics departments and TRIUMF for the years 2005 to 2009.

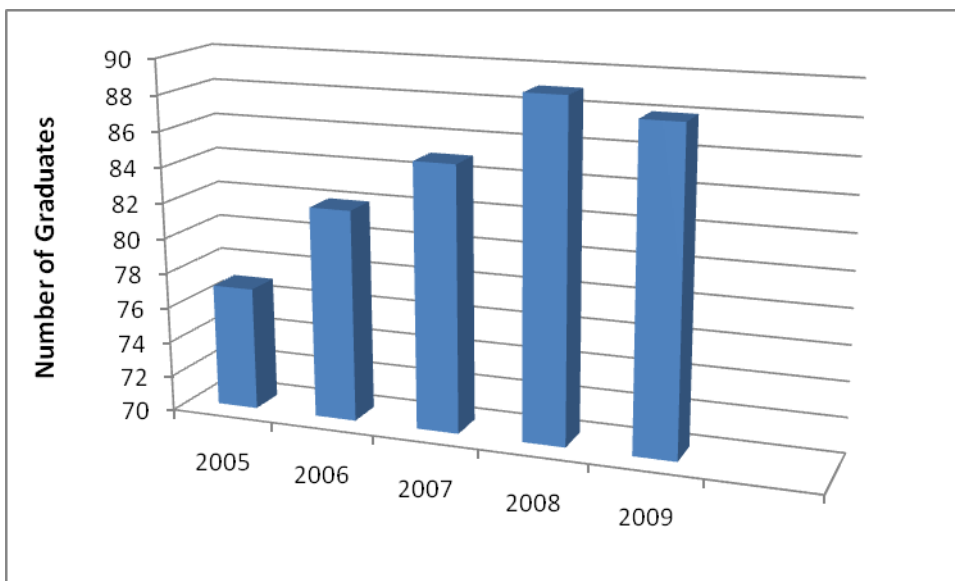

Fig. 4.3.2. Number of nuclear physics graduate students at Canadian physics departments and TRIUMF for the years 2005 to 2009.

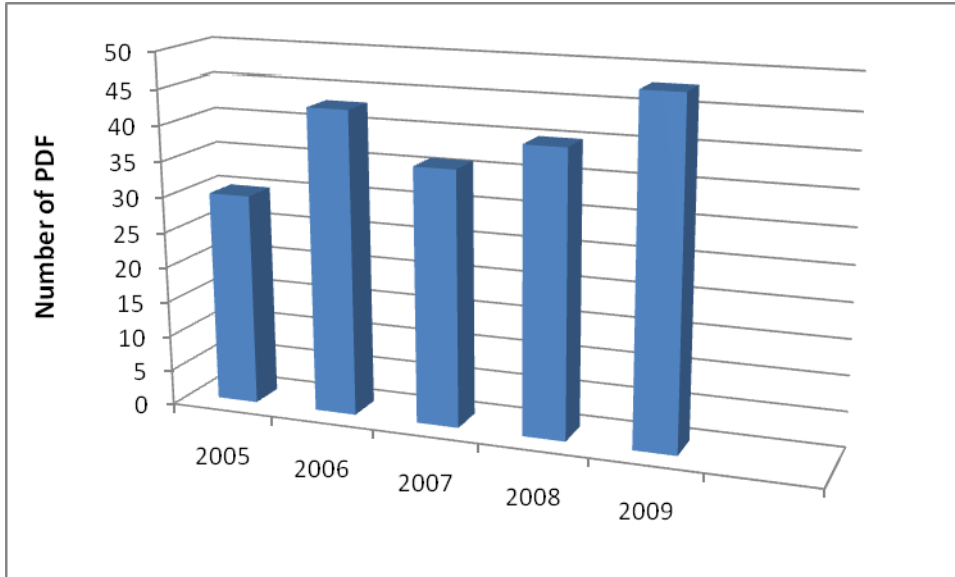

Fig. 4.3.3. Number of nuclear postdoctoral fellows (PDF) at Canadian physics departments and TRIUMF for the years 2005 to 2009.

The survey indicates a steady trend towards increased interest in nuclear science at the physics/chemistry departments and TRIUMF. Prognosis based on this trend and the scientific potential would point to continuous hiring of new faculty for at least 5 to 7 years to replace several members of our community that have retired and to capitalize on the new upgrades at TRIUMF. Still at this point the nuclear physics groups at most departments have not yet reached the size of other comparable fields, or the levels that nuclear physics groups have traditionally enjoyed at some Canadian institutions, the observed trends are certainly encouraging and indicate a dynamic field, committed to training of highly qualified personnel through research.

4.4 Funding Dynamics

4.4.1 Introduction:

Nuclear Physics in Canada draws its funds from several sources. The NSERC Discovery Grant program is far and above the most frequent mechanism used to obtain funds for the operating funds needed to carry out projects in this field. Within this program Project Grants with a typical duration of 3 years are the most common vehicle for funding. A few Individual Operating grants are also awarded. The funding of capital equipment is slightly more complex to describe and has become increasingly dependent on programs outside the purview of NSERC such as the CFI program.

4.4.2 Funding for research tools and instruments

Currently, most major installations and projects are funded in large part through the CFI program. Minor equipment relies on the part of the subatomic physics funding envelope that has traditionally designated for this purpose. The funding envelope for SAP has not seen any substantial increases in many years. The demands of increased operating costs brought about by new applicants, the construction of new facilities through funding initiatives not directly connected to the NSERC granting process, inflation and other factors, have eroded the amounts available for the construction of equipment. This weakens the ability of the NSERC SAPES to fund new tools and instruments in the field and reduces its ability to ensure an orderly and productive development of the field. While the availability of funds external to the envelope is highly desirable and has become in many cases the only way to mount significant new initiatives, the requirements of programs like the CFI make the application process more complex, time consuming and sometimes frustrating for the researchers. In particular, the requirements of matching funds from provinces and universities, in order for an application to go forward, can lead to complex and lengthy negotiations and the outcomes may not be driven primarily by the excellence of the science. For most researchers in this field, such new facilities will be located outside the province in which they reside. This has resulted in difficulties in convincing provincial agencies to provide matching funds for the construction of research infrastructure that will almost certainly find a permanent home in another province or country. Thankfully, this has not always been the case. Encouraging various agencies to take a national/international perspective when evaluating these applications would be desirable. Closer cooperation between the various granting agencies and their joint examination of the feasibility of operating these new facilities in the long term are also necessary to ensure optimum use of the funds.

4.4.3 International Contributions

4.4.3.1 International contributions at off-shore projects

In addition to funds from Canadian sources many projects also draw support from other international sources above and beyond international agreements that allow users access to experimental facilities. Canadian researchers at Argonne National Laboratory, Jefferson Laboratory and other international facilities have benefitted from such “local support” to significantly increase their scientific productivity beyond what would have been possible based solely on the value of their Canadian grants. Such support has also been very important to individuals and small groups of researchers working internationally to make significant contributions to our field.

4.4.3.2 International Contributions at TRIUMF

TRIUMF is the sole Canadian facility operating in the field of subatomic physics. The ISAC facility at TRIUMF is currently the world’s most powerful source of low and high energy beams of radioactive ions. The ISAC I and II facility hosts a very large collection of state of the art spectrometers and nuclear physics experiments. Because of this Canada is highly successful in attracting collaborators from USA, Europe, Japan, France and

other countries to participate in and launch new experiments at TRIUMF. Such activity brings significant amounts of capital funds to the facility to aid in the construction of experiments and build research infrastructure. The radon EDM experiment, the parity violation in francium experiment and the planned neutron EDM experiment are examples where significant funding from international sources has been pledged for future initiatives at TRIUMF. Many of the detector arrays in the fields of nuclear structure and nuclear astrophysics have also benefited from such agreements.

4.4.4 Groups, Projects and Individuals

Currently the funds granted to experimentalists in Canada are largely for groups or projects. It has been strongly suggested that this necessary in order to obtain the most scientific impact or the best “bang for the buck”. Given that most nuclear physics projects currently involve large, complex, installations, take a long time to develop and produce results, this is probably a reasonable model. Groups can share resources, provide a safety net for graduate students and share a common research theme that is easier to identify in the Canadian and international landscape. The formation of a gamma-ray spectroscopy group around the TIGRESS detector, the Qweak group at Jefferson Laboratory are examples of the power of this approach.

However, it is important to recognize that individuals from Canada are often part of strong international collaborations. They do not work in isolation and do use large international facilities as well. Their research also has a potential for high impact (as judged by the PAC’s) and provide unique opportunities for Canadian graduate and undergraduate students. The work carried out can be very cost effective because of their use of shared facilities and existing equipment. A modest investment in the work of individual researchers can result in significant scientific impact and in significant training opportunities for HQP. Any long range plan for the discipline should not overlook the contributions made by individual researchers.

4.5 Discipline dynamics and the CINP

The establishment of the CINP was one of the recommendations of the last NSERC SAP LRP exercise and has given the Canadian nuclear physics researchers the means to organize and voice their choices and opinions in a clear manner. The modest amount of funding received from NSERC and augmented by the membership dues from the 6 institutional members provides support for the activities of this organization in a manner that was simply impossible with the resources available to the Division of Nuclear Physics (DNP) of the Canadian Association of Physicists (CAP). The research focused membership of the CINP allows it to concentrate on the subjects relevant to maintaining a healthy nuclear physics research program in Canada. The membership of the CINP currently stands at 63. The membership is organized into 5 scientific working groups (SWG) with focused interests. Individuals can participate in multiple working groups if they choose.

Group	Members
Nuclear Structure	22
Nuclear Astrophysics	21
Fundamental Symmetries	29
Hadrons/QCD	17
Education	18
Total Membership in the CINP	63

Table 4.5.1. Membership in the CINP Scientific Working groups.

The working groups have used funds from the CINP to partly support the organization several workshops and conferences so far:

- Theory Canada 5 (organized by members of the Hadrons and QCD working group)
- Strong and Electroweak Matter (organized by members of the Hadrons and QCD working group)
- International Nuclear Physics Conference, INPC (Vancouver 2010)
- Physics Beyond the Standard Model (Organized by the Fundamental Symmetries working group, a satellite to the INPC 2010 conference)
- Nuclear Astrophysics in Canada (organized by the Nuclear Astrophysics working group, to be held December 9-10, 2010 at TRIUMF)

The first two conferences dealt with theory and the third and fourth had a mix of topics on theory and experiment. The fifth conference will also cover a mix of theory and experiment and, it is hoped, bring the nuclear astrophysics and stellar astronomy community under the umbrella of an institute similar to a modest version of the Joint Institute for Nuclear Astrophysics in the USA. The gathering of information for this brief and the formulation of this report represents a major undertaking for the working groups as well.

The CINP fulfills a long standing need of the Canadian nuclear physics research community for an organization to assess and communicate its needs and aspirations to the world. We hope that the maintaining of the information gathered about the research efforts, on an ongoing basis, will assist in the formulation of long range plans like this one for the discipline. The provision of modest funding and the framework for organizing workshops and conferences is becoming an effective tool to encourage communication and build a sense of community. The CINP plays an important role for the Canadian nuclear physics community and requires continued support in order to develop and fulfill its mandate.